



# FPF2193 / FPF2194 / FPF2195

## Full-Function Load Switch with Adjustable Current Limit

### Features

- <1.8 to 5.5 V Input Voltage Range
- Controlled Turn-On
- 0.1 to 1.5 A Adjustable Current Limit
- Under-Voltage Lockout
- Thermal Shutdown
- <2  $\mu$ A Shutdown Current
- Auto Restart
- Fast Current Limit Response Time
- 5  $\mu$ s to Moderate Over Currents
- 30 ns to Hard Shorts
- Fault Blanking
- Reverse Current Blocking

### Applications

- PDAs
- Cell Phones
- Handheld GPS Devices
- Portable Enterprise / Industrial Devices
- Digital Cameras
- Peripheral Ports and Accessories
- Portable Medical Equipment
- Hot Swap Supplies

### Description

The FPF2193, FPF2194, and FPF2195 form a series of load switches that provides full protection to systems and loads that may encounter large current conditions. These devices contain a 55 m $\Omega$  current-limited P-channel MOSFET that can operate over an input voltage range of 1.8 to 5.5 V. Internally, current is prevented from flowing when the MOSFET is off and the output voltage is higher than the input voltage. Switch control is by a logic input (ON) capable of interfacing directly with low-voltage control signals. Each part contains thermal shutdown protection that shuts off the switch to prevent damage to the part when a continuous over-current condition causes excessive heating.

When the switch current reaches the current limit, the parts operate in a constant-current mode to prohibit excessive currents from causing damage. For the FPF2193 and FPF2194, if the constant current condition still persists after 30 ms, the parts shut off the switch and pull the fault signal pin (FLAGB) LOW. The FPF2193 has an auto-restart feature that turns the switch on again after 450 ms if the ON pin is still active. The FPF2194 does not have this auto-restart feature, so the switch remains off until the ON pin is cycled. The FPF2195 does not turn off after a current limit fault, but remains in the constant-current mode indefinitely. The minimum current limit is 100 mA.

These parts are available in a space-saving six ball advanced 1 x 1.5 mm WLCSP package.

### Ordering Information

Part Number	Current Limit [mA]	Current Limit Blanking Time [ms]	Auto-Restart Time [ms]	ON Pin Activity	Top Mark
FPF2193	100-1500	15/30/60	225/450/900	Active HIGH	S6
FPF2194		15/30/60	NA		S7
FPF2195		0	NA		S9

### Application Diagram

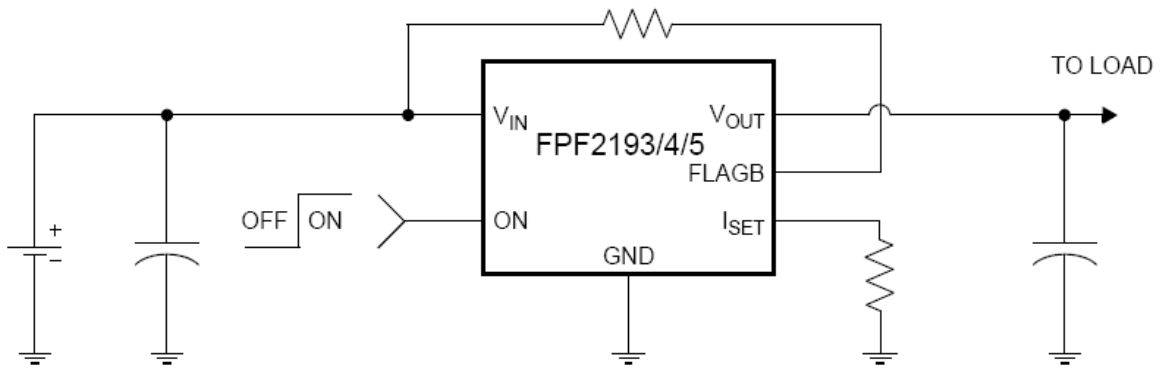

Figure 1. Typical Application

### Block Diagram

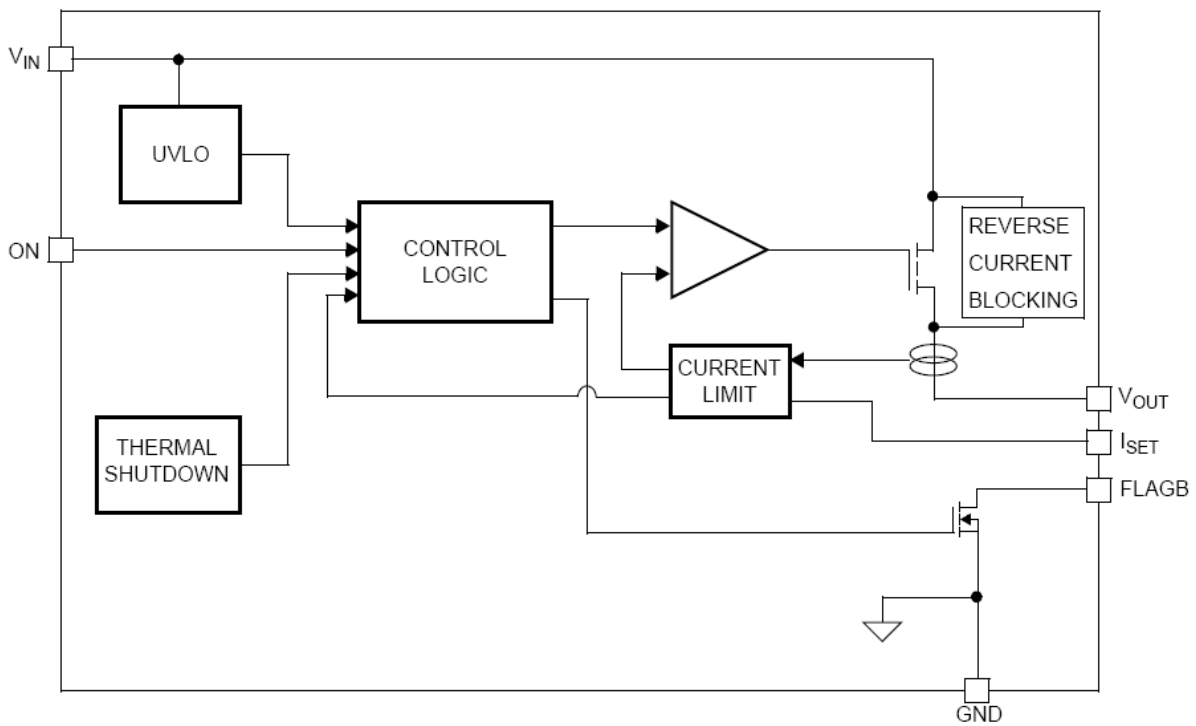

Figure 2. Functional Block Diagram

## Pin Configuration

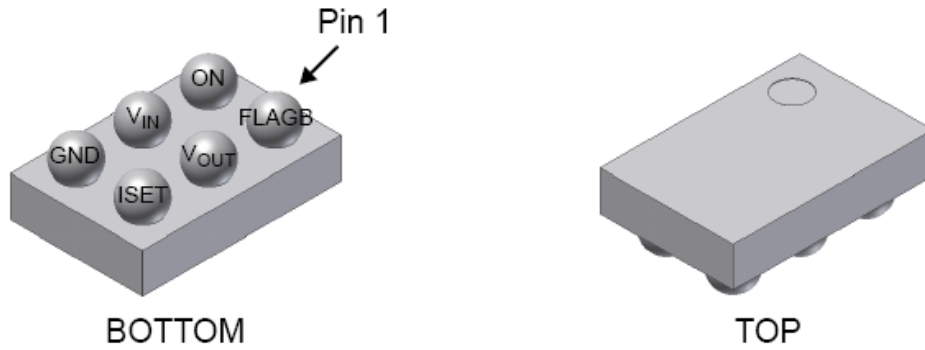

Figure 3. 1.0 x 1.5 mm Chip-Scale Package

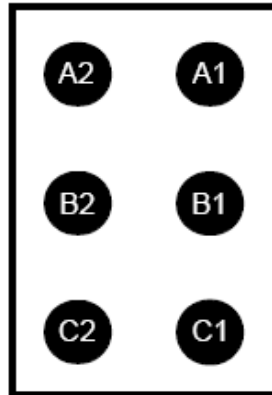

Figure 4. Pin Configuration (Bottom View)

## Pin Definitions

Pin #	Name	Description
C1	$I_{SET}$	Current Limit Set Input. A resistor from $I_{SET}$ to ground sets the current limit for the switch.
B2	$V_{IN}$	Supply Input. Input to the power switch and the supply voltage for the IC.
B1	$V_{OUT}$	Switch Output. Output of the power switch.
A1	FLAGB	Fault Output. Active LOW, open-drain output that indicates an over-current supply, under-voltage, or over-temperature state.
C2	GND	Ground.
A2	ON	ON control input, active HIGH.

## Absolute Maximum Ratings

Stresses exceeding the absolute maximum ratings may damage the device. The device may not function or be operable above the recommended operating conditions and stressing the parts to these levels is not recommended. In addition, extended exposure to stresses above the recommended operating conditions may affect device reliability. The absolute maximum ratings are stress ratings only.

Symbol	Parameter	Min.	Max.	Unit
	$V_{IN}$ , $V_{OUT}$ , ON, FLAGB, ISET to GND	-0.3	6.0	V
$P_D$	Power Dissipation at $T_A = 25^\circ\text{C}^{(1)}$		1.2	W
$T_J$	Operating Temperature Range	-40	+125	$^\circ\text{C}$
$T_{STG}$	Storage Temperature	-65	+150	$^\circ\text{C}$
$\theta_{JA}$	Thermal Resistance, Junction to Ambient		85	$^\circ\text{C/W}$
ESD	Electrostatic Discharge Capability	Human Body Model, JESD22-A114	8000	V
		Machine Model, JESD22-A115	400	

### Notes:

1. Package power dissipation on one-square inch pad, two-ounce copper board.

## Recommended Operating Conditions

The Recommended Operating Conditions table defines the conditions for actual device operation. Recommended operating conditions are specified to ensure optimal performance to the datasheet specifications. Fairchild does not recommend exceeding them or designing to Absolute Maximum Ratings.

Symbol	Parameter	Min.	Max.	Unit
$V_{IN}$	Input Voltage	1.8	5.5	V
$T_A$	Ambient Operating Temperature	-40	+85	$^\circ\text{C}$

## Electrical Characteristics

$V_{IN} = 1.8$  to  $5.5$  V,  $T_A = -40$  to  $+85^\circ\text{C}$  unless otherwise noted. Typical values are at  $V_{IN} = 3.3$  V and  $T_A = 25^\circ\text{C}$ .

Symbol	Parameter	Conditions	Min.	Typ.	Max.	Units
<b>Basic Operation</b>						
$V_{IN}$	Operating Voltage		1.8		5.5	V
$I_Q$	Quiescent Current	$I_{OUT}=0$ mA, $V_{ON}=V_{IN}$	$V_{IN}=1.8$ V	70		$\mu\text{A}$
			$V_{IN}=3.3$ V	75		
			$V_{IN}=5.5$ V	80		
$R_{ON}$	On Resistance	$T_A=25^\circ\text{C}$ , $I_{OUT}=200$ mA		55	80	$\text{m}\Omega$
		$T_A=-40$ to $85^\circ\text{C}$ , $I_{OUT}=200$ mA			135	
$V_{IH}$	On Input Logic High Voltage ON	$V_{IN}=1.8$ V	0.8			V
		$V_{IN}=5.5$ V	1.4			
$V_{IL}$	On Input Logic Low Voltage	$V_{IN}=1.8$ V			0.5	V
		$V_{IN}=\% .5$ V			1.0	
	On Input Leakage	$V_{ON}=V_{IN}$ or GND	-1	0	1	$\mu\text{A}$
	$V_{IN}$ Shutdown Current	$V_{ON}=0$ V, $V_{IN}=5.5$ V, $V_{OUT}=\text{Short to GND}$	-2		2	$\mu\text{A}$
$V_{FLB\_L}$	FLAGB Output Logic Low Voltage	$V_{IN}=5$ V, $I_{SINK}=10$ mA		0.05	0.20	V
		$V_{IN}=1.8$ , $I_{SINK}=10$ mA		0.12	0.30	
$V_{FLB\_H}$	FLAGB Output Logic High Leakage Current	$V_{IN}=5$ V, Switch ON			1	$\mu\text{A}$
<b>Reverse Block</b>						
$I_{SDT}$	$V_{OUT}$ Shutdown Current	$V_{ON}=0$ V, $V_{OUT}=5.5$ V, $V_{IN}=\text{Short-to-GND}$	-2		2	$\mu\text{A}$
$V_{breakdown}$	Reverse Breakdown Voltage	$V_{IN}=V_{ON}=0$ V, $I_{OUT}=200$ $\mu\text{A}$		9		V
<b>Protections</b>						
$I_{LIM}$	Current Limit	$V_{IN}=3.3$ V, $V_{OUT}=3.0$ V, $R_{SET}=690$ $\Omega$	600	800	1000	mA
$I_{LIM(MIN)}$	Minimum Current Limit	$V_{IN}=3.3$ V, $V_{OUT}=3.0$ V		100		ma
TSD	Thermal Shutdown	Shutdown Threshold		140		$^\circ\text{C}$
		Return from Shutdown		130		
		Hysteresis		10		
$V_{UVLO}$	Under-Voltage Lockout	$V_{IN}$ Increasing	1.55	1.65	1.75	V
$V_{UVLO\_HYST}$	Under-Voltage Lockout Hysteresis			50		mV
<b>Dynamic</b>						
$t_{dON}$	Delay On Time	$R_L=500$ $\Omega$ , $C_L=0.1$ $\mu\text{F}$		20		$\mu\text{s}$
$t_R$	$V_{OUT}$ Rise Time	$R_L=500$ $\Omega$ , $C_L=0.1$ $\mu\text{F}$		20		$\mu\text{s}$
$t_{ON}$	Turn-On Time	$R_L=500$ $\Omega$ , $C_L=0.1$ $\mu\text{F}$		40		$\mu\text{s}$
$t_{dOFF}$	Delay Off Time	$R_L=500$ $\Omega$ , $C_L=0.1$ $\mu\text{F}$		15		$\mu\text{s}$
$t_F$	$V_{OUT}$ Fall Time	$R_L=500$ $\Omega$ , $C_L=0.1$ $\mu\text{F}$		110		$\mu\text{s}$
$t_{OFF}$	Turn-Off Time	$R_L=500$ $\Omega$ , $C_L=0.1$ $\mu\text{F}$		125		$\mu\text{s}$
$t_{BLANK}$	Over-Current Blanking Time	PPF2193, PPF2194	15	30	60	ms
$t_{RSTRT}$	Auto-Restart	PPF2193	225	450	900	ms
		PPF2194, PPF2195		NA		
$t_{SC}$	Short-Circuit Response Time	$V_{IN}=V_{OUT}=3.3$ V, Moderate Over-Current Condition		5		$\mu\text{s}$
		$V_{IN}=V_{OUT}=3.3$ V, Hard Short		30		ns

## Typical Performance Characteristics

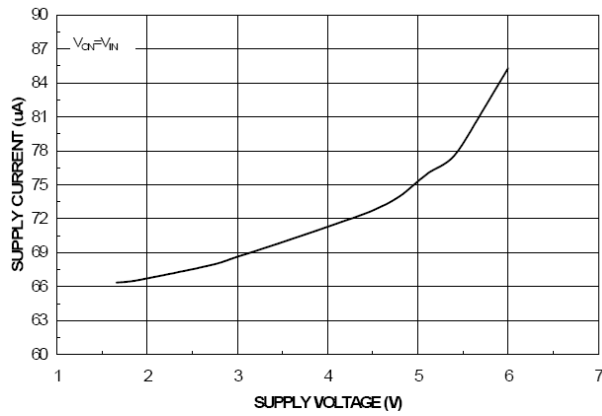

Figure 5. Quiescent Current vs. Input Voltage

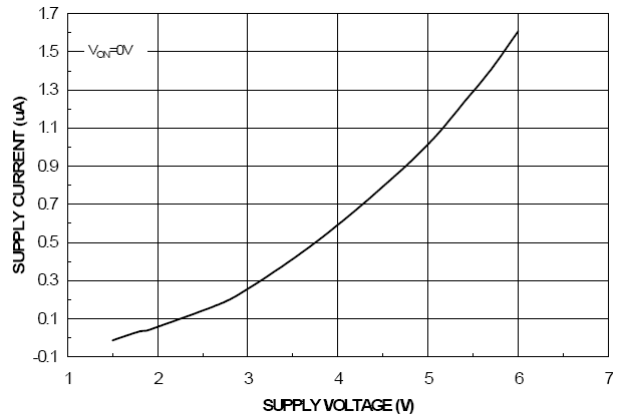

Figure 6. Quiescent Current vs. Input Voltage

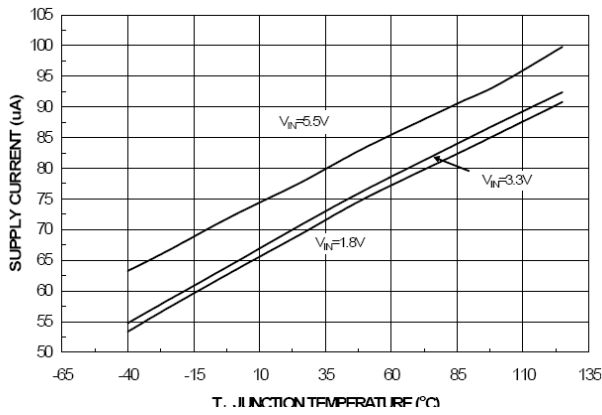

Figure 7. Quiescent Current vs. Temperature

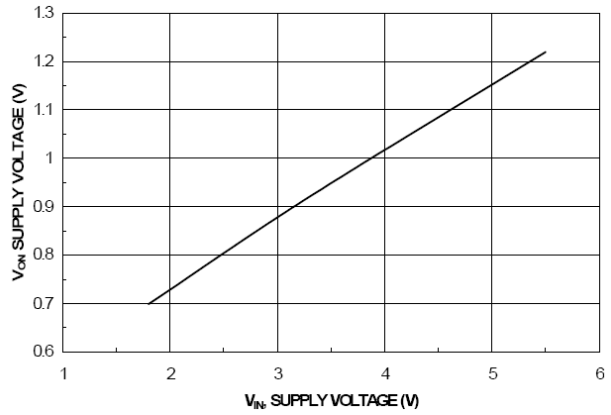

Figure 8.  $V_{ON}$  High Voltage vs. Input Voltage

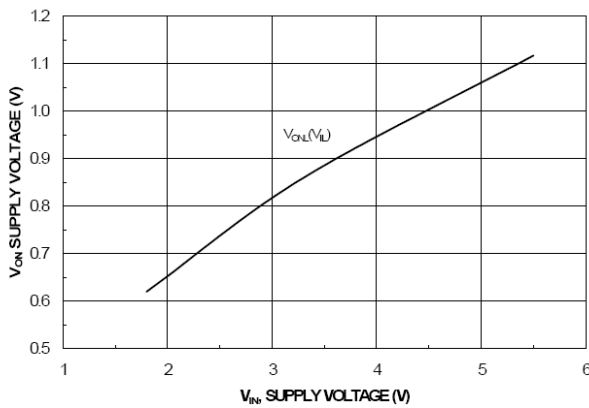

Figure 9.  $V_{ON}$  Low Voltage vs. Input Voltage

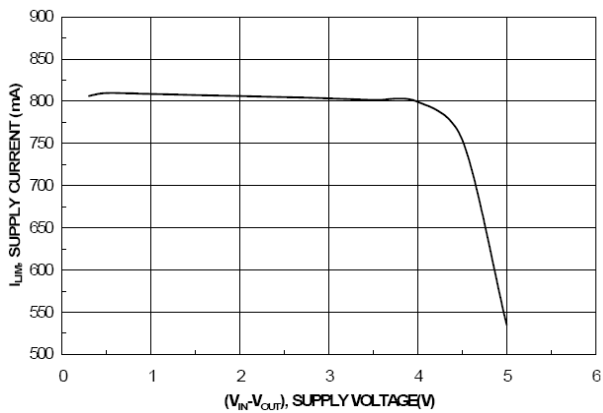

Figure 10. Current Limit vs. Output Voltage

## Typical Performance Characteristics (Continued)

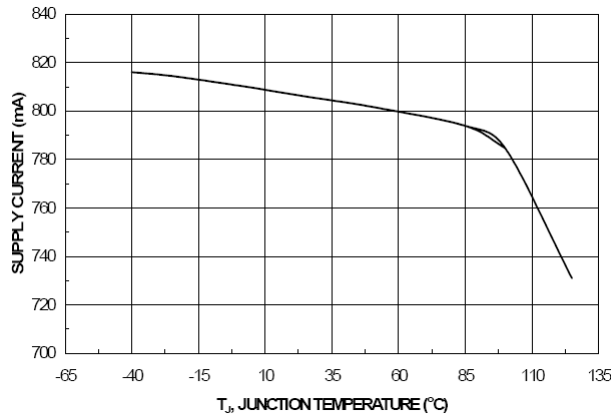

Figure 11. Current Limit vs. Temperature

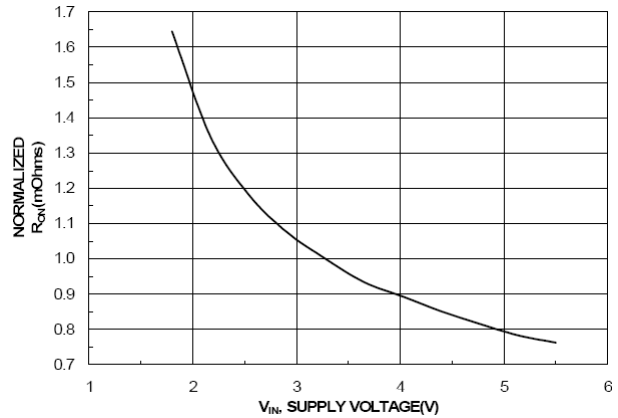

Figure 12.  $R_{ON}$  vs.  $V_{IN}$

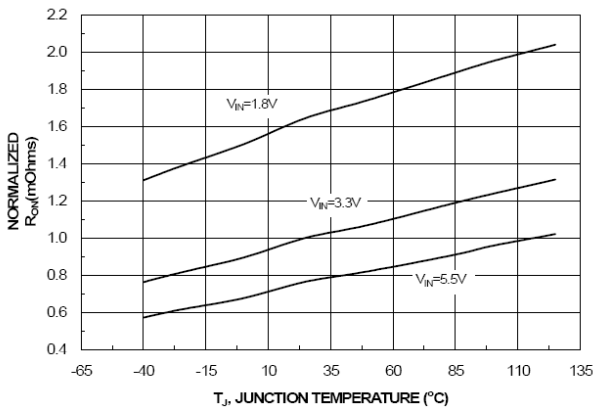

Figure 13.  $R_{ON}$  vs. Temperature

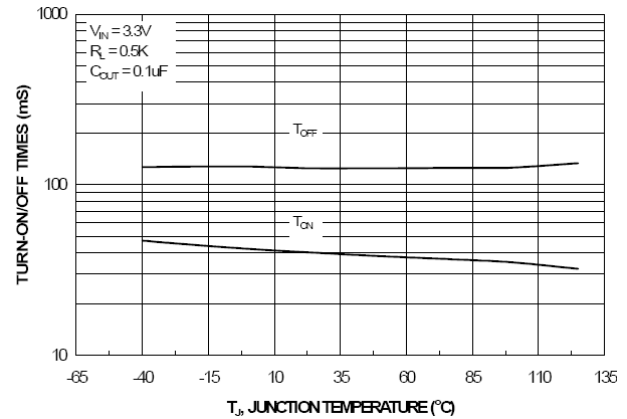

Figure 14.  $t_{ON} / t_{OFF}$  vs. Temperature

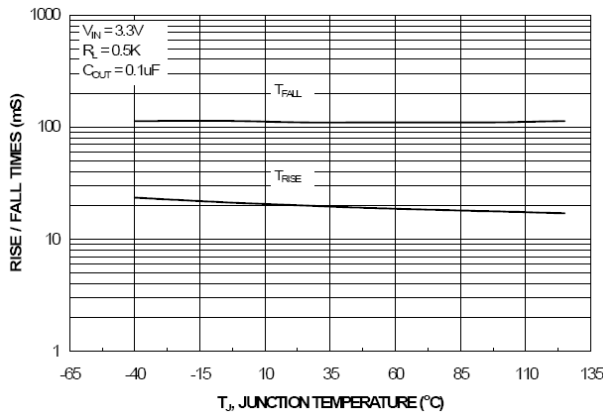

Figure 15.  $t_{RISE} / t_{FALL}$  vs. Temperature

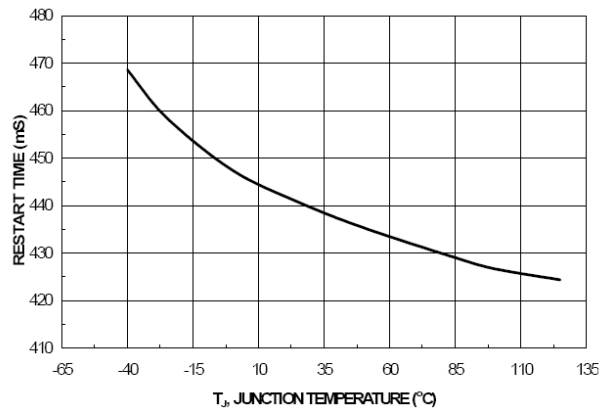

Figure 16.  $t_{RSTRT}$  vs. Temperature

Typical Performance Characteristics (Continued)

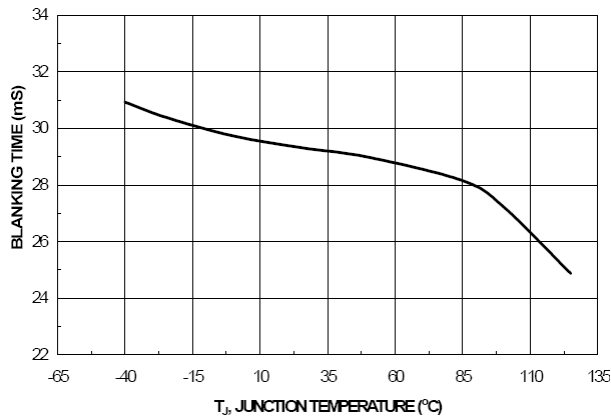

Figure 17.  $t_{BLANK}$  vs. Temperature

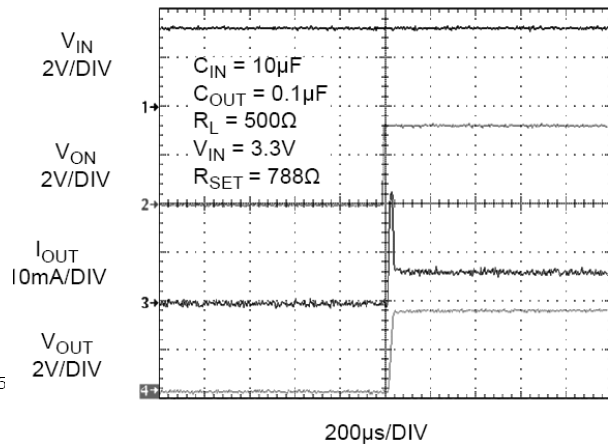

Figure 18.  $t_{ON}$  Response

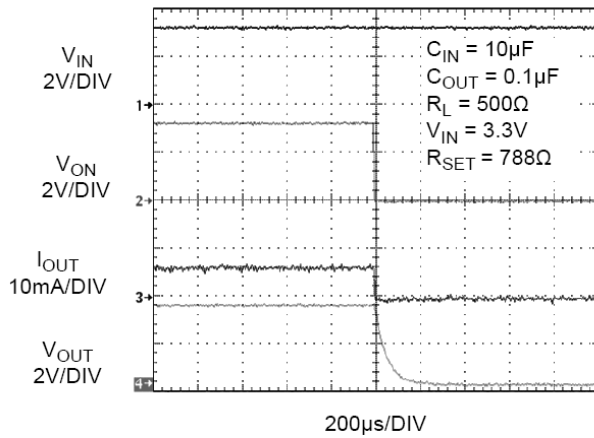

Figure 19.  $t_{OFF}$  Response

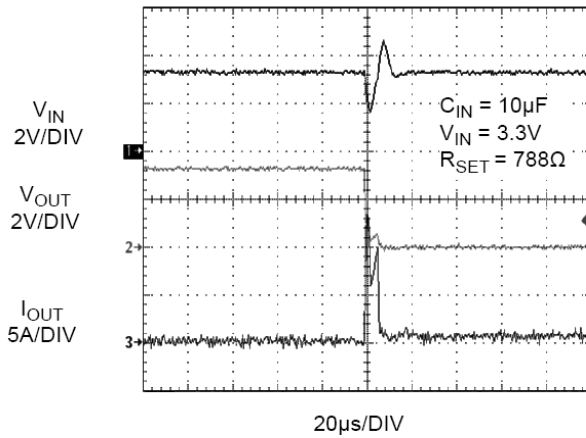

Figure 20. Short-Circuit Response Time (Output Shorted to GND)

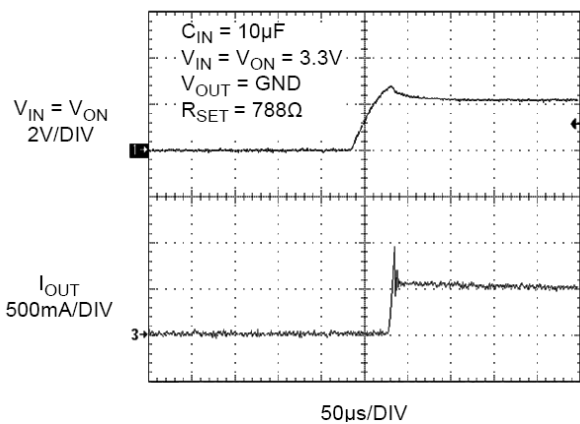

Figure 21. Current Limit Response Time (Switch is Powered into a Short)

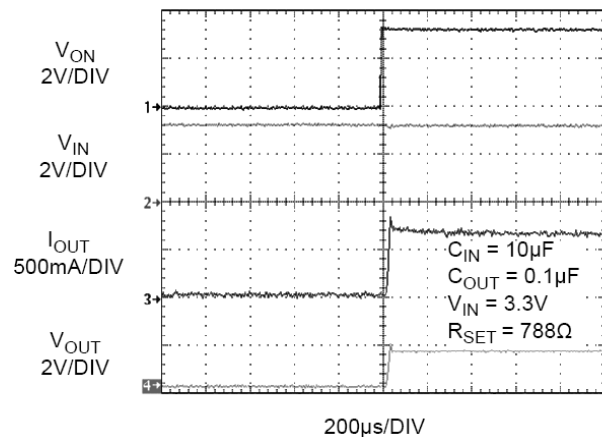

Figure 22. Current Limit Response Time (Output is Loaded by 2.2  $\Omega$ ,  $C_{OUT}=0.1 \mu F$ )



Typical Performance Characteristics (Continued)

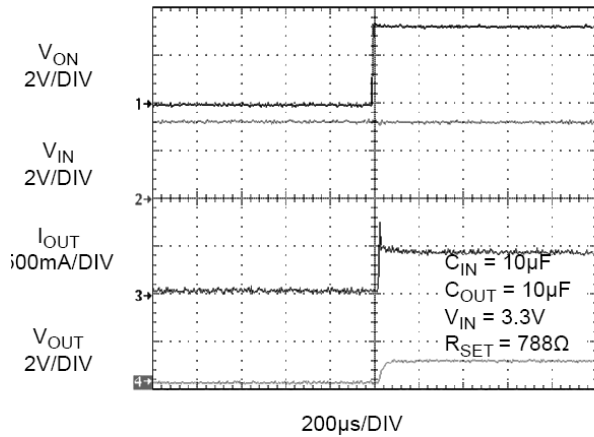

Figure 23. Current Limit Response Time (Output is Loaded by 2.2 Ω,  $C_{OUT}=10\mu F$ )

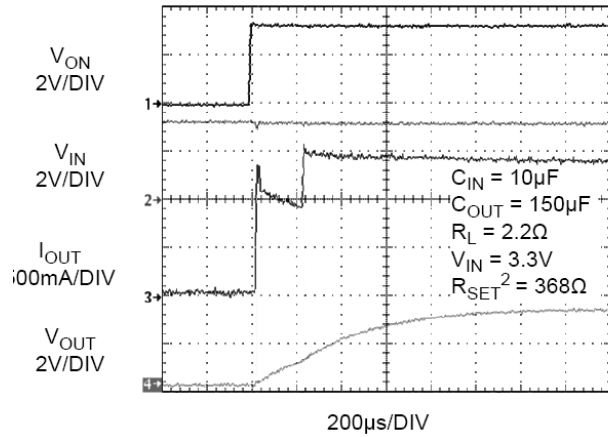

Figure 24. Short-Circuit Detection Function<sup>(2)</sup>

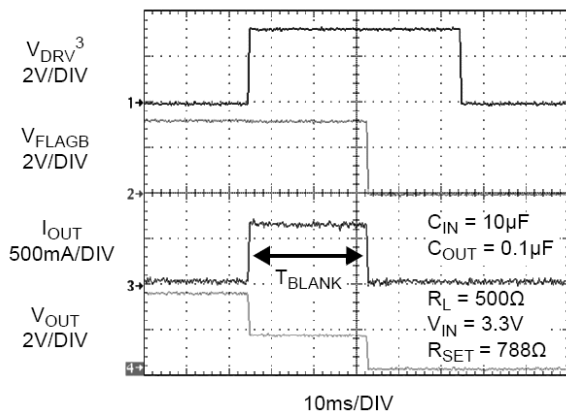

Figure 25.  $t_{BLANK}$  vs. Response<sup>(3)</sup>

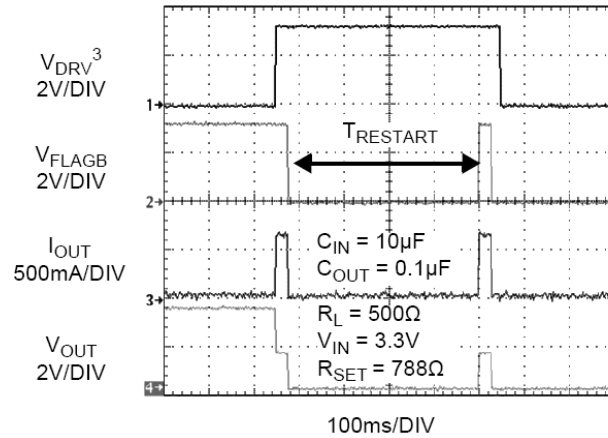

Figure 26.  $t_{RESTART}$  vs. Response<sup>(3)</sup>

Notes:

2. When the output voltage is below  $V_{SCTH}=1.1V$ , the current limit value is set at 62.5% of the current limit value.
3.  $V_{DRV}$  signal forces the device to go into over-current condition by loading.

## Functional Description

The FPF2193, FPF2194, and FPF2195 are current-limited switches that protect systems and loads that can be damaged or disrupted by the application of high currents. The core of each device is a 55 mΩ P-channel MOSFET and a controller capable of functioning over the wide input operating range of 1.8- 5.5 V. The controller protects against system malfunctions through current limiting, under-voltage lockout, and thermal shutdown. The current limit is adjustable from 100 mA to 1.5 A through the selection of an external resistor.

### On/Off Control

The ON pin controls the state of the switch. When ON is HIGH, the switch is in ON state. Activating ON continuously holds the switch in the ON state so long as there is no fault. For all versions, an under-voltage on  $V_{IN}$  or a junction temperature in excess of 140°C overrides the ON control to turn off the switch. In addition, excessive currents cause the switch to turn off in the FPF2193 and FPF2194. The FPF2193 has an auto-restart feature that automatically turns the switch on again after 450 ms. For the FPF2194, the ON pin must be toggled to turn the switch on again. The FPF2195 does not turn off in response to an over-current condition, but remains operating in constant-current mode as long as ON is active and the thermal shutdown or under-voltage lockout have not activated.

### Fault Reporting

Upon the detection of an over-current, input under-voltage, or over-temperature condition, FLAGB signals the fault mode by activating LOW. For the FPF2193 and FPF2194, the FLAGB goes LOW at the end of the blanking time, while FLAGB goes LOW immediately for the FPF2195. FLAGB remains LOW through the auto-restart time for the FPF2195. For the FPF2194, FLAGB is latched LOW and ON must be toggled to release it. With the FPF2195, FLAGB is LOW during the faults and immediately returns HIGH at the end of the fault condition. FLAGB is an open-drain MOSFET that requires a pull-up resistor between  $V_{IN}$  and FLAGB. During shutdown, the pull-down on FLAGB is disabled to reduce current draw from the supply.

### Current Limiting

The current limit ensures that the current through the switch doesn't exceed a maximum value, while not limiting at less than a minimum value. The current at which the parts limit is adjustable through the selection of an external resistor connected to  $I_{SET}$ . Information for selecting the resistor is found in the Application Information section. The FPF2193 and FPF2194 have a blanking time of 30 ms, nominally, during which the switch acts as a constant current source. At the end of the blanking time, the switch is turned off. The FPF2195 has no current limit blanking period, so it remains in a constant current state until the ON pin is deactivated or the thermal shutdown turns off the switch.

For preventing the switch from large power dissipation during heavy load, a short-circuit detection feature is introduced. Short-circuit condition is detected by, observing the output voltage. The switch is put into short-circuit current-limiting mode if the switch is loaded with a

heavy load. When the output voltage drops below  $V_{SCTH}$ , the short-circuit detection threshold voltage, the current limit value is re-conditioned and the short-circuit current-limit value is decreased to 62.5% of the current limit value. This keeps the power dissipation of the part below a certain limit even at dead-short conditions at 5.5 V input voltage. The  $V_{SCTH}$  value is set to be 1 V. At around 1.1 V of output voltage, the switch is removed from short-circuit current-limiting mode and the current limit is set to the current limit value.

### Under-Voltage Lockout (UVLO)

The under-voltage lockout turns the switch off if the input voltage drops below the under-voltage lockout threshold. With the ON pin active, the input voltage rising above the under-voltage lockout threshold causes a controlled turn-on of the switch, which limits current over shoot.

### Thermal Shutdown

The thermal shutdown protects the die from internally or externally generated excessive temperatures. During an over-temperature condition, FLAGB is activated and the switch is turned off. The switch automatically turns on again if temperature of the die drops below the threshold temperature.

### Reverse-Current Blocking

The entire FPF2193/94/95 family has a reverse current blocking feature that protects the input source against current flow from output to input. For a standard USB power design, this is an important feature to protect the USB host from being damaged due to reverse current flow on  $V_{BUS}$ .

When the load switch is OFF, no current flows from the output to the input. If the switch is turned on and the output voltage is greater than input voltage, this feature is activated and turns off the switch. This prevents any current flow from output to input. The reverse-current blocking feature is deactivated if the  $V_{OUT} - V_{IN}$  is smaller than a typically 50 mV threshold. During this time, some current ( $50 \text{ mV}/R_{ON}$ ) flows from the output to input until input voltage becomes greater than output voltage. FLAGB operation is independent of the reverse-current blocking and does not report a fault condition if this feature is activated.

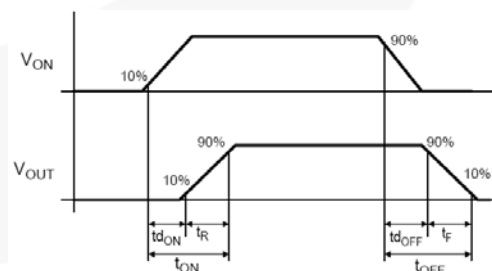

Figure 27. Timing Diagram

where:

$t_{dON}$  = Delay On Time

$t_r$  =  $V_{OUT}$  Rise Time

$t_{ON}$  = Turn-On Time

$t_{dOFF}$  = Delay Off Time

$t_f$  =  $V_{OUT}$  Fall Time

$t_{OFF}$  = Turn-Off Time

## Application Information

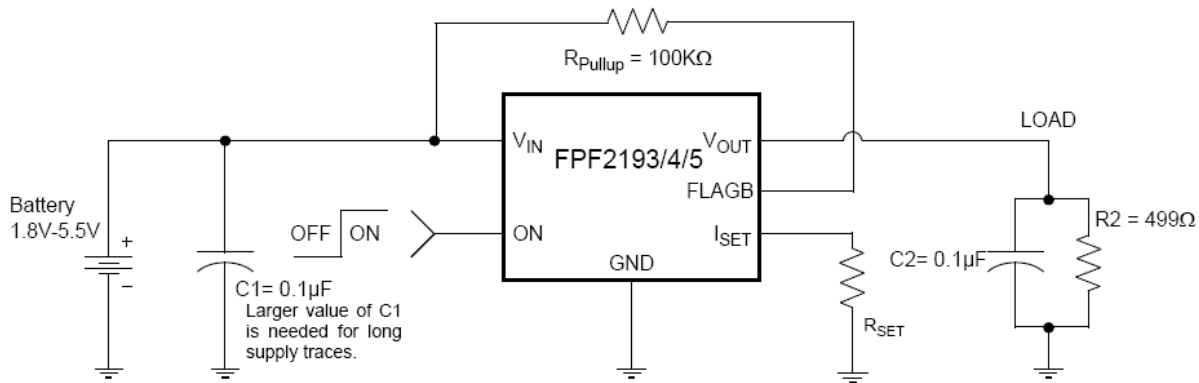

Figure 28. Typical Application

### Setting Current Limit

The FPF2193, FPF2194, and FPF2195 current limit is set with an external resistor connected between  $I_{SET}$  and GND. This resistor is selected using the following equation:

$$R_{SET} = \frac{551.6}{I_{LIM}} \quad (1)$$

$R_{SET}$  is in  $\Omega$  and  $I_{SET}$  is in Amps.

Table 1 can also be used to select  $R_{SET}$ . A typical application would be the 500 mA current required by a single USB port. Using Table 1, an appropriate selection for the  $R_{SET}$  resistor would be 788  $\Omega$ . This ensures that the port load could draw 525 mA, but not more than 875 mA. Likewise for a dual-port system; an  $R_{SET}$  of 368  $\Omega$  always delivers at least 1125 mA and never more than 1875 mA.

Table 1. Current Limit Various  $R_{SET}$  Values

$R_{SET}(\Omega)$	Min. Current Limit (mA)	Typ. Current Limit (mA)	Max. Current Limit (mA)
368	1125	1500	1875
441	928	1250	1562
552	750	1000	1250
613	675	900	1125
690	600	800	1000
788	525	700	875
919	450	600	750
1103	375	500	625
1226	338	450	563
1379	300	400	500
1576	263	350	438
1839	225	300	375
2206	188	250	313
2758	150	200	250
3677	113	150	188
5516	75	100	125

### Input Capacitor

To limit the voltage drop on the input supply caused by transient inrush currents when the switch is turned on into a discharged load capacitor or a short-circuit, a capacitor needs to be placed between  $V_{IN}$  and GND. A 0.1  $\mu F$  ceramic capacitor,  $C_{IN}$ , placed close to the pins is usually sufficient. Higher values of  $C_{IN}$  can be used to further reduce the voltage drop.

### Output Capacitor

A 0.1  $\mu F$  capacitor,  $C_{OUT}$ , should be placed between  $V_{OUT}$  and GND. This capacitor prevents parasitic board inductances from forcing  $V_{OUT}$  below GND when the switch turns off. For the FPF2193 and FPF2194, the total output capacitance needs to be kept below a maximum value,  $C_{OUT(max)}$ , to prevent the part from registering an over-current condition and turning off the switch. The maximum output capacitance can be determined from the following formula:

$$C_{OUT(max)} = \frac{I_{LIM(max)} \times t_{BLANK(min)}}{V_{IN}} \quad (2)$$

### Power Dissipation

During normal operation as a switch, the power dissipated depends upon the level at which the current limit is set. The maximum allowed setting for the current limit is 1.5 A and results in a power dissipation of:

$$P = (I_{LIM})^2 \times R_{ON} = (1.5)^2 \times 0.055 = 123.75mW \quad (3)$$

If the part goes into current limit, the maximum power dissipation occurs when the output is shorted to ground. For the FPF2193, the power dissipation scales by the auto-restart time,  $t_{RSTRT}$ , and the over-current blanking time,  $t_{BLANK}$ , so that the maximum power dissipated is:

$$P(max) = \frac{t_{BLANK}}{t_{BLANK} + t_{RSTRT}} \times V_{IN(max)} \times I_{LIM(max)} \quad (4)$$

$$= \frac{30}{30 + 450} \times 5.5 \times 1.5 = 515.6mW$$

This is more power than the package can dissipate, but the thermal shutdown of the part activates to protect the part from damage due to excessive heating. When using the FPF2194, attention must be given to the manual resetting of the part. The junction temperature is only able to increase to the thermal shutdown threshold. Once this temperature has been reached, toggling ON does not turn the switch on until the junction temperature drops. For the FPF2195, a short on the output causes the part to operate in a constant-current state, dissipating a worst-case power of:

$$\begin{aligned} P(\text{max}) &= V_{\text{IN}}(\text{max}) \times I_{\text{LIM}}(\text{max}) \\ &= 5.5 \times 1.5 = 8.25\text{W} \end{aligned} \quad (5)$$

This large amount of power activates the thermal shutdown and the part cycles in and out of thermal shutdown as long as the ON pin is active and the short is present.

## Board Layout

For best performance, all traces should be as short as possible. To be most effective, the input and output capacitors should be placed close to the device to minimize the effects that parasitic trace inductances may have on normal and short-circuit operation. Using wide traces for  $V_{\text{IN}}$ ,  $V_{\text{OUT}}$ , and GND help to minimize parasitic electrical effects along with minimizing the case-to-ambient thermal impedance.

### Physical Dimensions

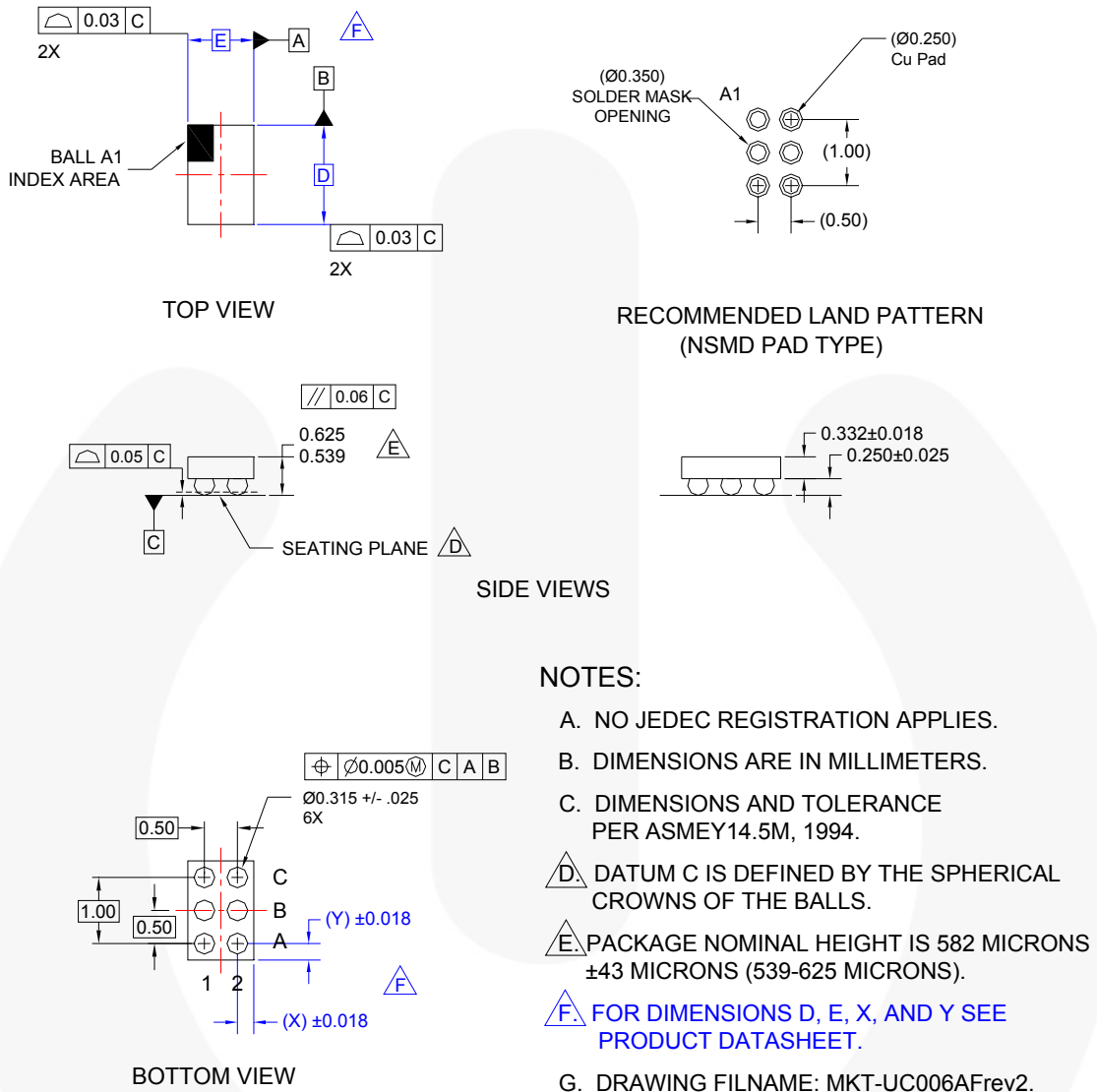

**Figure 29. 6-Ball, Wafer-Level Chip-Scale Package (WLCSP)**

Product	D	E	X	Y
FPF2193	1.500±0.030	1.000±0.030	0.240	0.240
FPF2194	1.500±0.030	1.000±0.030	0.240	0.240
FPF2195	1.500±0.030	1.000±0.030	0.240	0.240

Package drawings are provided as a service to customers considering Fairchild components. Drawings may change in any manner without notice. Please note the revision and/or date on the drawing and contact a Fairchild Semiconductor representative to verify or obtain the most recent revision. Package specifications do not expand the terms of Fairchild's worldwide terms and conditions, specifically the warranty therein, which covers Fairchild products.

Always visit Fairchild Semiconductor's online packaging area for the most recent package drawings:  
<http://www.fairchildsemi.com/packaging/>.



**TRADEMARKS**

The following includes registered and unregistered trademarks and service marks, owned by Fairchild Semiconductor and/or its global subsidiaries, and is not intended to be an exhaustive list of all such trademarks.

- |   |  |   |   |
|---|--|---|---|
| 2Cool™  | F-PFS™   | PowerTrench®  | The Power Franchise®  |
| AccuPower™  | FRFET®   | PowerXS™  | <b>the power franchise</b>  |
| AX-CAP™*  | Global Power Resource™                         | Programmable Active Droop™  | TinyBoost™  |
| BitSiC™   | GreenBridge™                                   | QFET®   | TinyBuck™   |
| Build it Now™   | Green FPS™                                     | QST™  | TinyCalc™   |
| CorePLUSTM  | Green FPS™ e-Series™                           | Quiet Series™   | TinyLogic®  |
| CorePOWER™  | Gmax™  | RapidConfigure™   | TINYOPTO™   |
| CROSSVOLT™  | GTO™   |  | TinyPower™  |
| CTL™  | IntelliMAX™                                    | Saving our world, 1mW/W/KV at a time™   | TinyPWM™  |
| Current Transfer Logic™   | ISOPLANAR™                                     | SignalWise™   | TinyWire™   |
| DEUXPEED®   | Making Small Speakers Sound Louder and Better™ | SmartMax™   | TranSiC™  |
| Dual Cool™  | MegaBuck™                                      | SMART START™  | TriFault Detect™  |
| EcoSPARK®   | MICROCOUPLER™                                  | Solutions for Your Success™   | TRUECURRENT®  |
| EfficientMax™   | MicroFET™                                      | SPM®  | µSerDes™  |
| ESBC™   | MicroPak™                                      | STEALTH™  |  |
|  | MicroPak2™                                     | SuperFET®   | UHC®  |
| Fairchild®  | MillerDrive™                                   | SuperSOT™-3   | Ultra FRFET™  |
| Fairchild Semiconductor®  | MotionMax™                                     | SuperSOT™-8   | UniFET™   |
| FACT Quiet Series™  | mVWSaver™                                      | SuperSOT™-8   | VCO™  |
| FACT®   | OptoHiT™                                       | SupreMOS®   | VisualMax™  |
| FAST®   | OPTOLOGIC®                                     | SyncFET™  | VoltagePlus™  |
| FastvCore™  | OPTOPLANAR®                                    | Sync-Lock™  | XST™  |
| FETBench™   |  |  |   |
| FPS™  |  |   |   |

\* Trademarks of System General Corporation, used under license by Fairchild Semiconductor.

**DISCLAIMER**

FAIRCHILD SEMICONDUCTOR RESERVES THE RIGHT TO MAKE CHANGES WITHOUT FURTHER NOTICE TO ANY PRODUCTS HEREIN TO IMPROVE RELIABILITY, FUNCTION, OR DESIGN. FAIRCHILD DOES NOT ASSUME ANY LIABILITY ARISING OUT OF THE APPLICATION OR USE OF ANY PRODUCT OR CIRCUIT DESCRIBED HEREIN, NEITHER DOES IT CONVEY ANY LICENSE UNDER ITS PATENT RIGHTS, NOR THE RIGHTS OF OTHERS. THESE SPECIFICATIONS DO NOT EXPAND THE TERMS OF FAIRCHILD'S WORLDWIDE TERMS AND CONDITIONS, SPECIFICALLY THE WARRANTY THEREIN, WHICH COVERS THESE PRODUCTS.

**LIFE SUPPORT POLICY**

FAIRCHILD'S PRODUCTS ARE NOT AUTHORIZED FOR USE AS CRITICAL COMPONENTS IN LIFE SUPPORT DEVICES OR SYSTEMS WITHOUT THE EXPRESS WRITTEN APPROVAL OF FAIRCHILD SEMICONDUCTOR CORPORATION.

As used herein:

1. Life support devices or systems are devices or systems which, (a) are intended for surgical implant into the body or (b) support or sustain life, and (c) whose failure to perform when properly used in accordance with instructions for use provided in the labeling, can be reasonably expected to result in a significant injury of the user.
2. A critical component in any component of a life support, device, or system whose failure to perform can be reasonably expected to cause the failure of the life support device or system, or to affect its safety or effectiveness.

**ANTI-COUNTERFEITING POLICY**

Fairchild Semiconductor Corporation's Anti-Counterfeiting Policy. Fairchild's Anti-Counterfeiting Policy is also stated on our external website, [www.fairchildsemi.com](http://www.fairchildsemi.com), under Sales Support.

Counterfeiting of semiconductor parts is a growing problem in the industry. All manufacturers of semiconductor products are experiencing counterfeiting of their parts. Customers who inadvertently purchase counterfeit parts experience many problems such as loss of brand reputation, substandard performance, failed applications, and increased cost of production and manufacturing delays. Fairchild is taking strong measures to protect ourselves and our customers from the proliferation of counterfeit parts. Fairchild strongly encourages customers to purchase Fairchild parts either directly from Fairchild or from Authorized Fairchild Distributors who are listed by country on our web page cited above. Products customers buy either from Fairchild directly or from Authorized Fairchild Distributors are genuine parts, have full traceability, meet Fairchild's quality standards for handling and storage and provide access to Fairchild's full range of up-to-date technical and product information. Fairchild and our Authorized Distributors will stand behind all warranties and will appropriately address any warranty issues that may arise. Fairchild will not provide any warranty coverage or other assistance for parts bought from Unauthorized Sources. Fairchild is committed to combat this global problem and encourage our customers to do their part in stopping this practice by buying direct or from authorized distributors.

**PRODUCT STATUS DEFINITIONS**

**Definition of Terms**

Datasheet Identification	Product Status	Definition
Advance Information	Formative / In Design	Datasheet contains the design specifications for product development. Specifications may change in any manner without notice.
Preliminary	First Production	Datasheet contains preliminary data; supplementary data will be published at a later date. Fairchild Semiconductor reserves the right to make changes at any time without notice to improve design.
No Identification Needed	Full Production	Datasheet contains final specifications. Fairchild Semiconductor reserves the right to make changes at any time without notice to improve the design.
Obsolete	Not In Production	Datasheet contains specifications on a product that is discontinued by Fairchild Semiconductor. The datasheet is for reference information only.

Rev. 163