

GATES

4070B—QUAD EXCLUSIVE—OR GATE
4037B—QUAD EXCLUSIVE—NOR GATE

- MEDIUM-SPEED OPERATION $t_{PHL} = t_{PLH} = 70\text{ns}$ (typ.) AT $V_{CC} = 10\text{V}$, $C_L = 50\text{pF}$
- QUIESCENT CURRENT SPECIFIED TO 20V FOR HCC DEVICE
- 5V, 10V AND 15V PARAMETRIC RATING
- INPUT CURRENT OF 100nA AT 18V AND 25°C FOR HCC DEVICE
- 100% TESTED FOR QUIESCENT CURRENT
- MEETS ALL REQUIREMENTS OF JEDEC TENTATIVE STANDARD No. 13A, "STANDARD SPECIFICATIONS FOR DESCRIPTION OF "B" SERIES CMOS DEVICES"

DESCRIPTION

The **HCC4070B/4077B** (extended temperature range) and **HCF4070B/4077B** (intermediate temperature range) are monolithic integrated circuits, available in 14-lead dual in-line plastic or ceramic package and plastic micropackage.

The **HCC/HCF4070B** contains four independent exclusive-OR gates.

The **HCC/HCF4077B** contains four independent exclusive-NOR gates.

The **HCC/HCF4070B** and **HCC/HCF4077B** provide the system designer with a means for direct implementation of the exclusive-OR and exclusive-NOR function, respectively. For applications as Logical comparators, Adders/subtractors, Parity generators and checkers.

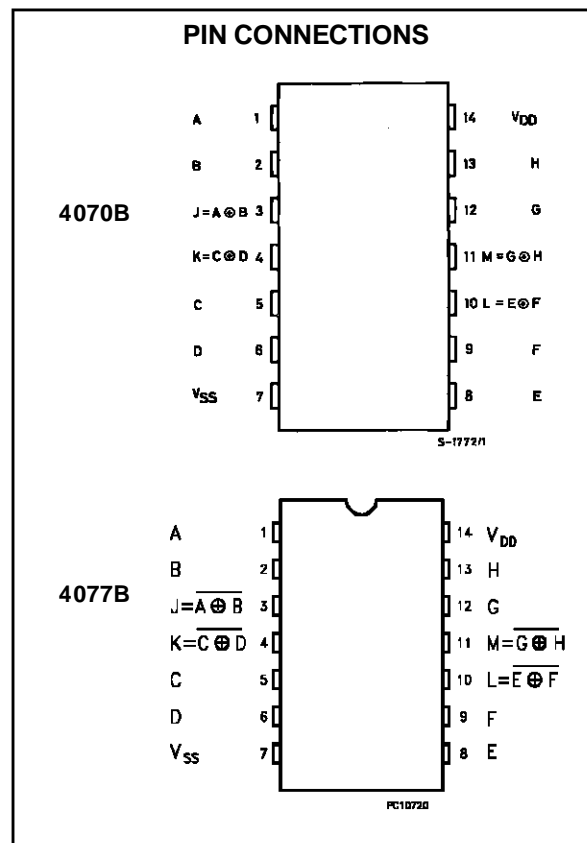
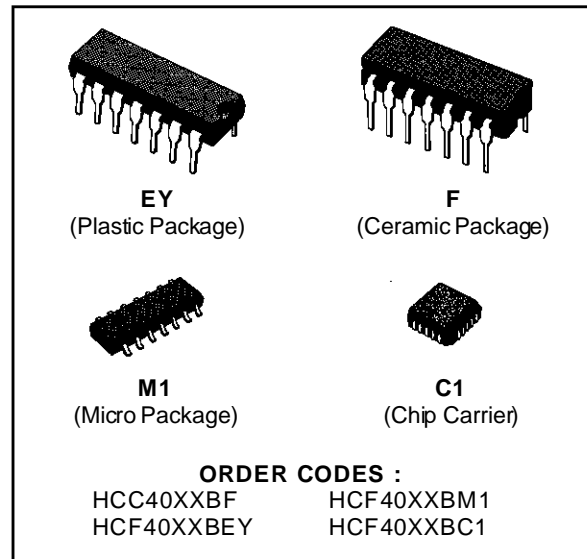

HCC/HCF4070B/4077B

FUNCTIONAL DIAGRAM

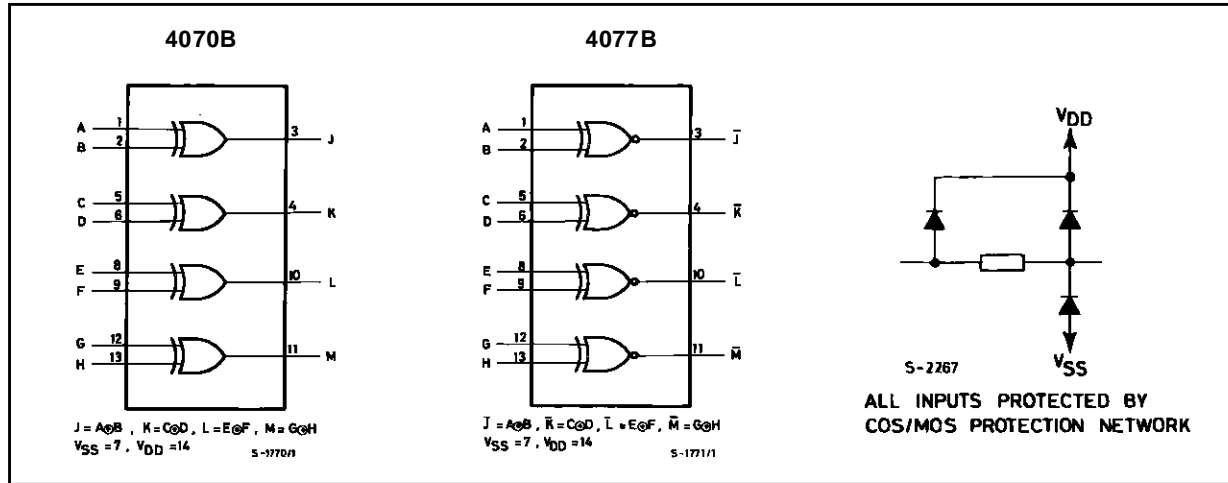

ABSOLUTE MAXIMUM RATING

Symbol	Parameter	Value	Unit
V_{DD}^*	Supply Voltage: HCC Types HCF Types	-0.5 to +20 -0.5 to +18	V V
V_i	Input Voltage	-0.5 to $V_{DD} + 0.5$	V
I_i	DC Input Current (any one input)	± 10	mA
P_{tot}	Total Power Dissipation (per package) Dissipation per Output Transistor for T_{op} = Full Package Temperature Range	200 100	mW mW
T_{op}	Operating Temperature: HCC Types HCF Types	-55 to +125 -40 to +85	$^{\circ}C$ $^{\circ}C$
T_{stg}	Storage Temperature	-65 to +150	$^{\circ}C$

Stresses above those listed under "Absolute Maximum Ratings" may cause permanent damage to the device. This is a stress rating only and functional operation of the device at these or any other conditions above those indicated in the operational sections of this specification is not implied. Exposure to absolute maximum rating conditions for external periods may affect device reliability.

* All voltage values are referred to V_{SS} pin voltage.

RECOMMENDED OPERATING CONDITIONS

Symbol	Parameter	Value	Unit
V_{DD}	Supply Voltage: HCC Types HCF Types	3 to 18 3 to 15	V V
V_i	Input Voltage	0 to V_{DD}	V
T_{op}	Operating Temperature: HCC Types HCF Types	-55 to +125 -40 to +85	$^{\circ}C$ $^{\circ}C$

TRUTH TABLES (1 of 4 gates)

HCC4070B		
A	B	J
0	0	0
1	0	1
0	1	1
1	1	0

HCC4077B		
A	B	J
0	0	1
1	0	0
0	1	0
1	1	1

STATIC ELECTRICAL CHARACTERISTICS (over recommended operating conditions)

Symbol	Parameter		Test Conditions				Value						Unit	
			V _I (V)	V _O (V)	I _O (μ A)	V _{DD} (V)	T _{LOW} *		25 °C			T _{HIGH} *		
							Min.	Max.	Min.	Typ.	Max.	Min.		Max.
I _L	Quiescent Current	HCC Types	0/5			5		1		0.02	1		30	μ A
			0/10			10		2		0.02	2		60	
			0/15			15		4		0.02	4		120	
		0/20			20		20		0.04	20		600		
		HCF Types	0/5			5		4		0.02	4		30	
			0/10			10		8		0.02	8		60	
0/15				15		16		0.02	16		120			
V _{OH}	Output High Voltage	0/5		< 1	5	4.95		4.95			4.95		V	
		0/10		< 1	10	9.95		9.95			9.95			
		0/15		< 1	15	14.95		14.95			14.95			
V _{OL}	Output Low Voltage	5/0		< 1	5		0.05			0.05		0.05	V	
		10/0		< 1	10		0.05			0.05		0.05		
		15/0		< 1	15		0.05			0.05		0.05		
V _{IH}	Input High Voltage	0.5/4.5	< 1	5	3.5		3.5				3.5		V	
		1/9	< 1	10	7		7				7			
		1.5/13.5	< 1	15	11		11				11			
V _{IL}	Input Low Voltage	4.5/0.5	< 1	5		1.5			1.5		1.5		V	
		9/1	< 1	10		3			3		3			
		13.5/1.5	< 1	15		4			4		4			
I _{OL}	Output Drive Current	HCC Types	0/5	2.5		5	-2		-1.6	-3.2		-1.15	mA	
			0/5	4.6		5	-0.64		-0.51	-1		-0.36		
			0/10	9.5		10	-1.6		-1.3	-2.6		-0.9		
		0/15	13.5		15	-4.2		-3.4	-6.8		-2.4			
		HCF Types	0/5	2.5		5	-1.53		-1.36	-3.2		-1.1		
			0/5	4.6		5	-0.52		-0.44	-1		-0.36		
0/10	9.5			10	-1.3		-1.1	-2.6		-0.9				
0/15	13.5		15	-3.6		-3.0	-6.8		-2.4					
I _{OL}	Output Sink Current	HCC Types	0/5	0.4		5	0.64		0.51	1		0.36	mA	
			0/10	0.5		10	1.6		1.3	2.6		0.9		
			0/15	1.5		15	4.2		3.4	6.8		2.4		
		HCF Types	0/5	0.4		5	0.52		0.44	1		0.36		
			0/10	0.5		10	1.3		1.1	2.6		0.9		
			0/15	1.5		15	3.6		3.0	6.8		2.4		
I _{IH} , I _{IL}	Input Leakage Current	HCC Types	0/18	Any Input	18		\pm 0.1		\pm 10 ⁻⁵	\pm 0.1		\pm 1	μ A	
		HCF Types	0/15		15		\pm 0.3		\pm 10 ⁻⁵	\pm 0.3		\pm 1		
C _i	Input Capacitance			Any Input					5	7.5			pF	

* T_{LOW} = -55 °C for HCC device; -40 °C for HCF device.

* T_{HIGH} = +125 °C for HCC device; +85 °C for HCF device.

The Noise Margin for both "1" and "0" level is: 1V min. with V_{DD} = 5V, 2V min. with V_{DD} = 10V, 2.5V min. with V_{DD} = 15V

HCC/HCF4070B/4077B

DYNAMIC ELECTRICAL CHARACTERISTICS ($T_{amb} = 25\text{ }^{\circ}\text{C}$, $C_L = 50\text{ pF}$, $R_L = 200\text{ K}\Omega$, typical temperature coefficient for all V_{DD} values is $03\text{ } \%/^{\circ}\text{C}$, all input rise and fall times = 20 ns)

Symbol	Parameter	Test Conditions		Value			Unit
		V_{DD} (V)		Min.	Typ.	Max.	
t_{PLH} t_{PHL}	Propagation Delay Time	5			140	280	ns
		10			65	130	
		15			50	100	
t_{TLH} t_{THL}	Transition Time	5			100	200	ns
		10			50	100	
		15			40	80	

Minimum Output High (source) Current Characteristics.

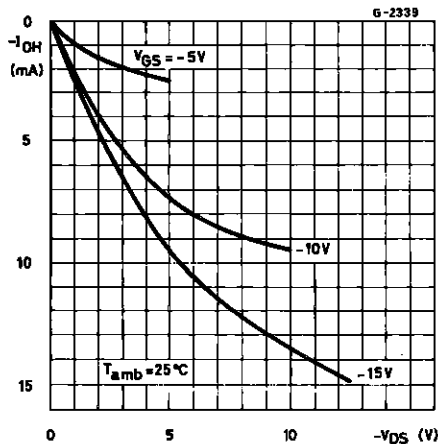

Typical Output Low (sink) Current.

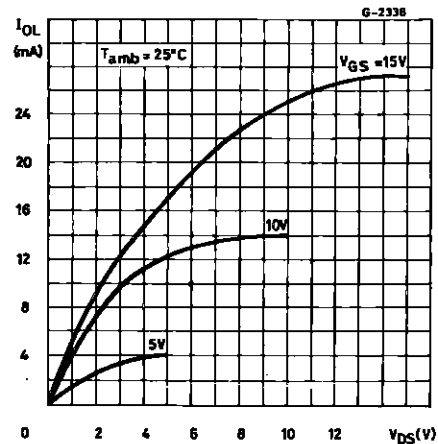

Minimum Output Low (sink) Current Characteristics.

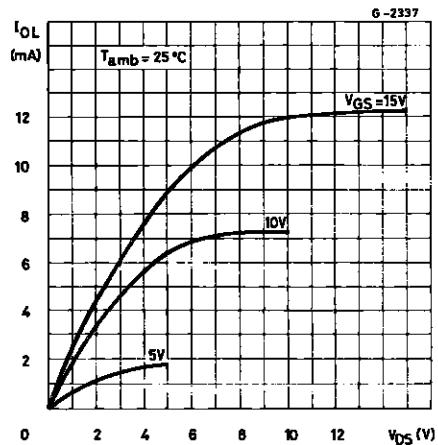

Typical Output High (source) Current Characteristics.

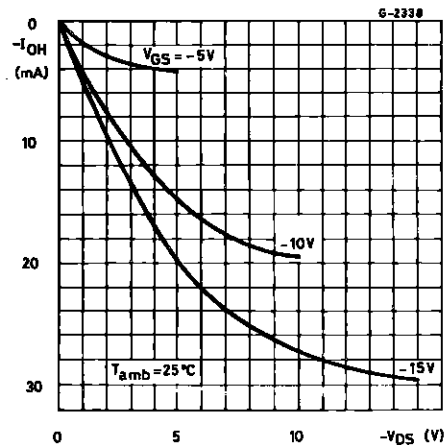

Typical Transition Time vs. Load Capacitance.

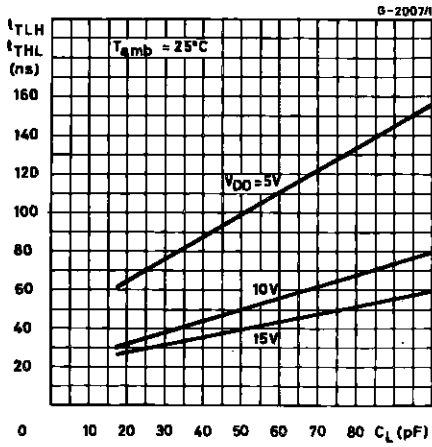

Typical Propagation Delay Time vs. Load Capacitance.

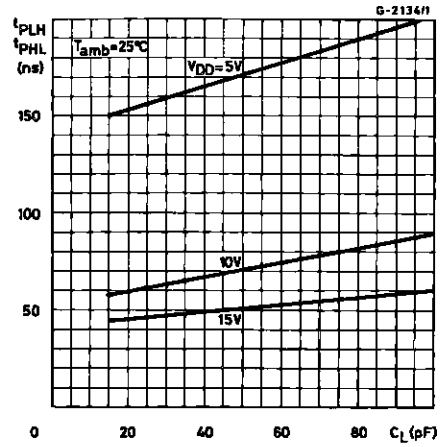

Typical Propagation Delay Time vs. Supply Voltage.

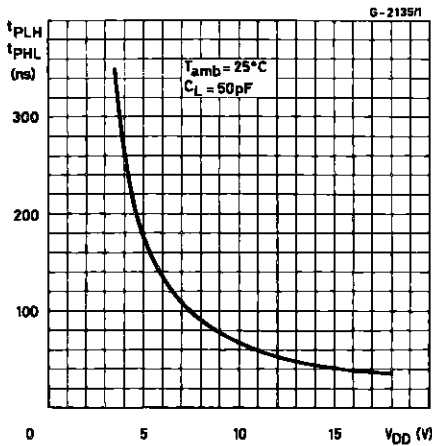

Typical Dynamic Power Dissipation vs. Input Frequency.

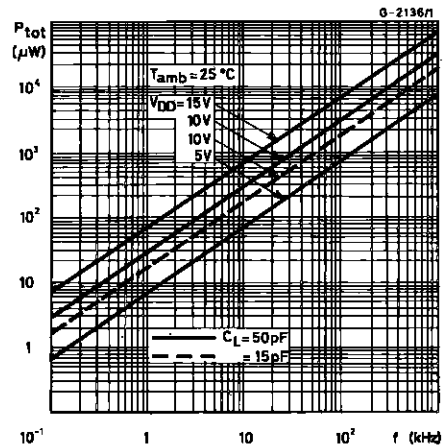

TEST CIRCUIT

Quiescent Device Current

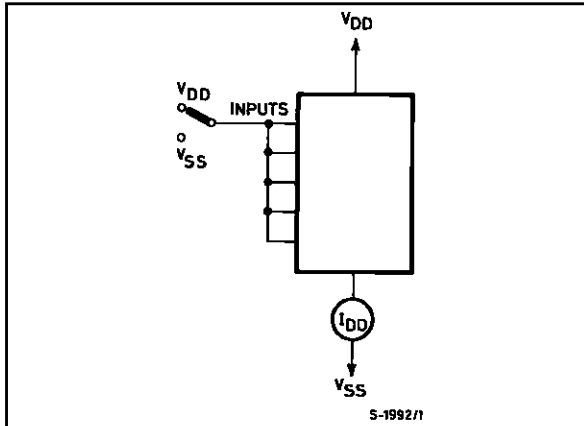

Input Voltage.

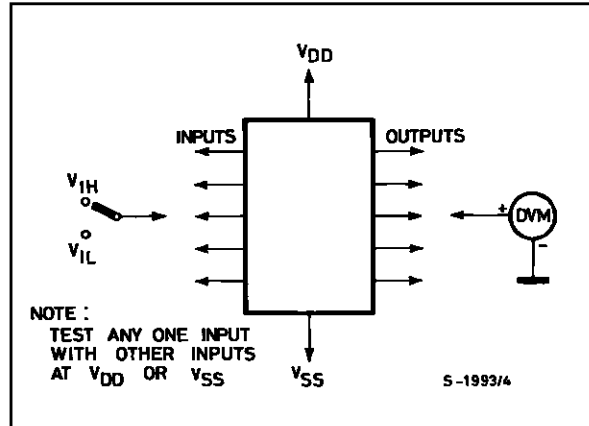

Input Leakage Current.

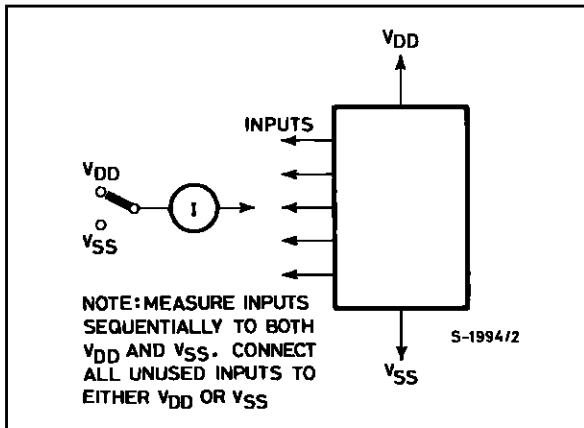

Plastic DIP14 MECHANICAL DATA

DIM.	mm			inch		
	MIN.	TYP.	MAX.	MIN.	TYP.	MAX.
a1	0.51			0.020		
B	1.39		1.65	0.055		0.065
b		0.5			0.020	
b1		0.25			0.010	
D			20			0.787
E		8.5			0.335	
e		2.54			0.100	
e3		15.24			0.600	
F			7.1			0.280
I			5.1			0.201
L		3.3			0.130	
Z	1.27		2.54	0.050		0.100



Ceramic DIP14/1 MECHANICAL DATA

DIM.	mm			inch		
	MIN.	TYP.	MAX.	MIN.	TYP.	MAX.
A			20			0.787
B			7.0			0.276
D		3.3			0.130	
E	0.38			0.015		
e3		15.24			0.600	
F	2.29		2.79	0.090		0.110
G	0.4		0.55	0.016		0.022
H	1.17		1.52	0.046		0.060
L	0.22		0.31	0.009		0.012
M	1.52		2.54	0.060		0.100
N			10.3			0.406
P	7.8		8.05	0.307		0.317
Q			5.08			0.200



P053C

SO14 MECHANICAL DATA

DIM.	mm			inch		
	MIN.	TYP.	MAX.	MIN.	TYP.	MAX.
A			1.75			0.068
a1	0.1		0.2	0.003		0.007
a2			1.65			0.064
b	0.35		0.46	0.013		0.018
b1	0.19		0.25	0.007		0.010
C		0.5			0.019	
c1	45° (typ.)					
D	8.55		8.75	0.336		0.344
E	5.8		6.2	0.228		0.244
e		1.27			0.050	
e3		7.62			0.300	
F	3.8		4.0	0.149		0.157
G	4.6		5.3	0.181		0.208
L	0.5		1.27	0.019		0.050
M			0.68			0.026
S	8° (max.)					

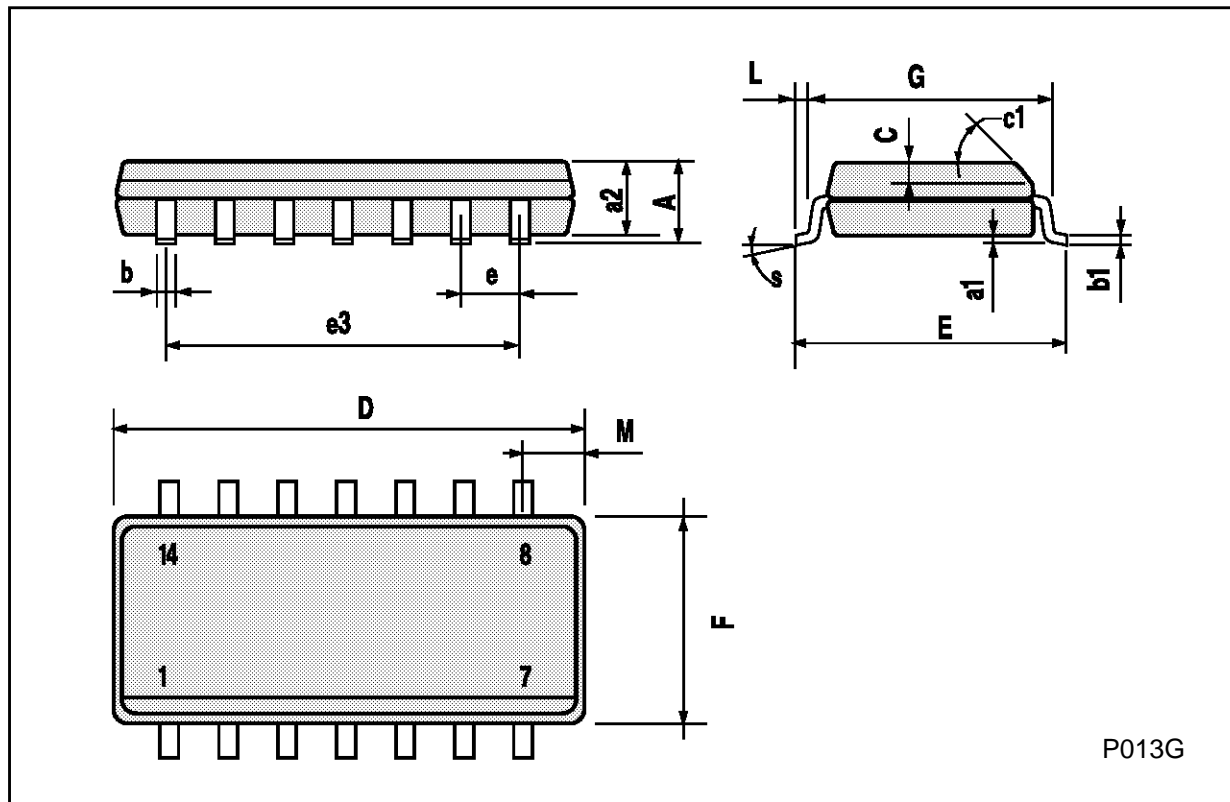

PLCC20 MECHANICAL DATA

DIM.	mm			inch		
	MIN.	TYP.	MAX.	MIN.	TYP.	MAX.
A	9.78		10.03	0.385		0.395
B	8.89		9.04	0.350		0.356
D	4.2		4.57	0.165		0.180
d1		2.54			0.100	
d2		0.56			0.022	
E	7.37		8.38	0.290		0.330
e		1.27			0.050	
e3		5.08			0.200	
F		0.38			0.015	
G			0.101			0.004
M		1.27			0.050	
M1		1.14			0.045	



Information furnished is believed to be accurate and reliable. However, SGS-THOMSON Microelectronics assumes no responsibility for the consequences of use of such information nor for any infringement of patents or other rights of third parties which may result from its use. No license is granted by implication or otherwise under any patent or patent rights of SGS-THOMSON Microelectronics. Specifications mentioned in this publication are subject to change without notice. This publication supersedes and replaces all information previously supplied. SGS-THOMSON Microelectronics products are not authorized for use as critical components in life support devices or systems without express written approval of SGS-THOMSON Microelectronics.

© 1994 SGS-THOMSON Microelectronics - All Rights Reserved

SGS-THOMSON Microelectronics GROUP OF COMPANIES

Australia - Brazil - France - Germany - Hong Kong - Italy - Japan - Korea - Malaysia - Malta - Morocco - The Netherlands -
Singapore - Spain - Sweden - Switzerland - Taiwan - Thailand - United Kingdom - U.S.A