

EVALUATION KIT AVAILABLE

MAXIM

5V/3.3V/3V/Adjustable, High-Efficiency, Low I_Q , Step-Down DC-DC Converters

General Description

The MAX639/MAX640/MAX653 step-down switching regulators provide high efficiency over a wide range of load currents, delivering up to 225mA. A current-limiting pulse-frequency-modulated (PFM) control scheme gives the devices the benefits of pulse-width-modulated (PWM) converters (high efficiency at heavy loads), while using only 10 μ A of supply current (vs. 2mA to 10mA for PWM converters). The result is high efficiency over a wide range of loads.

The MAX639/MAX640/MAX653 input range is 4V to 11.5V, and the devices provide lower preset output voltages of 5V, 3.3V, and 3V, respectively. Or, the output can be user-adjusted to any voltage from 1.3V to the input voltage.

The MAX639/MAX640/MAX653 have an internal 1A power MOSFET switch, making them ideal for minimum-component, low- and medium-power applications. For increased output drive capability, use the MAX649/MAX651/MAX652 step-down controllers, which drive an external P-channel FET to deliver up to 5W.

Applications

9V Battery to 5V, 3.3V, or 3V Conversion
High-Efficiency Linear Regulator Replacement
Portable Instruments and Handy-Terminals
5V-to-3.3V Converters

Features

- ♦ High Efficiency for a Wide Range of Load Currents
- ♦ 10 μ A Quiescent Current
- ♦ Output Currents Up to 225mA
- ♦ Preset or Adjustable Output Voltage:
 - 5.0V (MAX639)
 - 3.3V (MAX640)
 - 3.0V (MAX653)
- ♦ Low-Battery Detection Comparator
- ♦ Current-Limiting PFM Control Scheme

Ordering Information

PART	TEMP. RANGE	PIN-PACKAGE
MAX639CPA	0°C to +70°C	8 Plastic DIP
MAX639CSA	0°C to +70°C	8 SO
MAX639C/D	0°C to +70°C	Dice*
MAX639EPA	-40°C to +85°C	8 Plastic DIP
MAX639ESA	-40°C to +85°C	8 SO
MAX639MJA	-55°C to +125°C	8 CERDIP

Ordering Information continued on last page.

* Contact factory for dice specifications.

Typical Operating Circuit

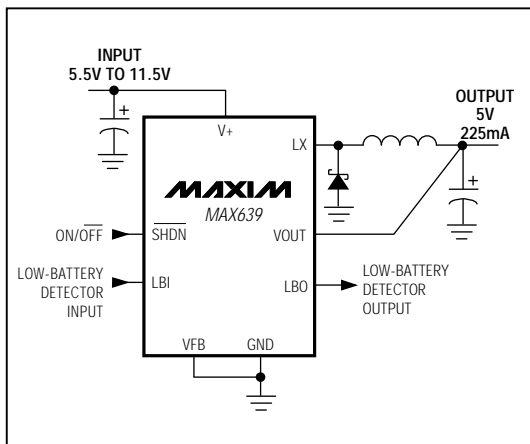

Pin Configuration

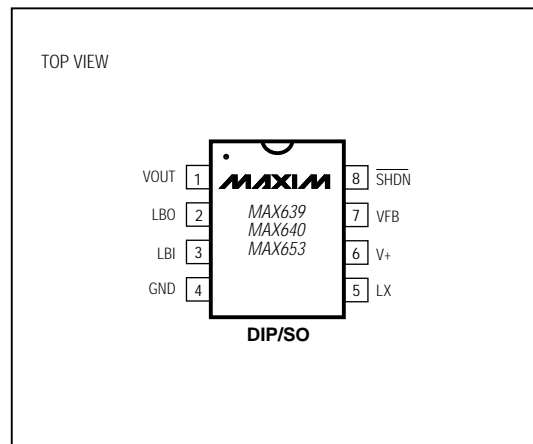
**MAXIM**

Maxim Integrated Products 1

Call toll free 1-800-998-8800 for free samples or literature.

MAX639/MAX640/MAX653

5V/3.3V/3V/Adjustable, High-Efficiency, Low I_Q, Step-Down DC-DC Converters

ABSOLUTE MAXIMUM RATINGS

V+12V
LX(V+ - 12V) to (V+ + 0.3V)
LBI, LBO, VFB, SHDN, VOUT-0.3V to (V+ + 0.3V)
LX Output Current (Note 1)1A
LBO Output Current10mA
Continuous Power Dissipation (T _A = +70°C)	
Plastic DIP (derate 9.09mW/°C above +70°C)727mW
SO (derate 5.88mW/°C above +70°C)471mW
CERDIP (derate 8.00mW/°C above +70°C)640mW

Operating Temperature Ranges:	
MAX639C_0°C to +70°C
MAX639E_-40°C to +85°C
MAX639MJA-55°C to +125°C
Storage Temperature Range-65°C to +160°C
Lead Temperature (soldering, 10sec)+300°C

Note 1: Peak inductor current must be limited to 600mA by using an inductor of 100µH or greater.

Stresses beyond those listed under "Absolute Maximum Ratings" may cause permanent damage to the device. These are stress ratings only, and functional operation of the device at these or any other conditions beyond those indicated in the operational sections of the specifications is not implied. Exposure to absolute maximum rating conditions for extended periods may affect device reliability.

ELECTRICAL CHARACTERISTICS

(V+ = 9V for the MAX639, V+ = 5V for the MAX640/MAX653, I_{LOAD} = 0mA, T_A = T_{MIN} to T_{MAX}, typical values are at T_A = +25°C, unless otherwise noted.)

PARAMETER	CONDITIONS		MIN	TYP	MAX	UNITS
Supply Voltage			4.0		11.5	V
Supply Current	SHDN = V+, no load			10	20	µA
Output Voltage (Note 2)	MAX639, V+ = 6.0V to 11.5V, 0mA < I _{OUT} < 100mA		4.80	5.00	5.20	V
	MAX640, V+ = 4.0V to 11.5V, 0mA < I _{OUT} < 100mA		3.17	3.30	3.43	
	MAX653, V+ = 4.0V to 11.5V, 0mA < I _{OUT} < 100mA		2.88	3.00	3.12	
Dropout Voltage	I _{OUT} = 100mA, L = 100µH			0.5		V
Efficiency	MAX639	I _{OUT} = 100mA, L = 100µH		91		%
		I _{OUT} = 25mA, L = 470µH		94		
	MAX640	I _{OUT} = 100mA, L = 100µH		87		
		I _{OUT} = 25mA, L = 470µH		91		
	MAX653	I _{OUT} = 100mA, L = 100µH		85		
		I _{OUT} = 25mA, L = 470µH		89		
Switch On-Time	MAX639	V+ = 9V, V _{OUT} = 5V	10.6	12.5	14.4	µs
		V+ = 6V, V _{OUT} = 3V	14.2	16.7	19.2	
	MAX640	V+ = 9V, V _{OUT} = 3.3V	7.5	8.8	10.1	
		V+ = 4V, V _{OUT} = 3.3V	60.7	71.4	82.1	
	MAX653	V+ = 9V, V _{OUT} = 3V	7.1	8.3	9.5	
		V+ = 4V, V _{OUT} = 3V	42.5	50.0	57.5	
Switch Off-Time	MAX639	V+ = 9V, V _{OUT} = 5V	9.0	11.7	13.5	µs
		V+ = 6V, V _{OUT} = 3V	16.6	19.5	22.4	
	MAX640	V+ = 9V, V _{OUT} = 3.3V	13.3	15.6	17.9	
		V+ = 4V, V _{OUT} = 3.3V	13.3	15.6	17.9	
	MAX653	V+ = 9V, V _{OUT} = 3V	14.6	17.2	19.8	
		V+ = 4V, V _{OUT} = 3V	14.6	17.2	19.8	

5V/3.3V/3V/Adjustable, High-Efficiency, Low I_Q , Step-Down DC-DC Converters

MAX639/MAX640/MAX653

ELECTRICAL CHARACTERISTICS (continued)

(V_+ = 9V for the MAX639, V_+ = 5V for the MAX640/MAX653, I_{LOAD} = 0mA, T_A = T_{MIN} to T_{MAX} , typical values are at T_A = +25°C, unless otherwise noted.)

PARAMETER	CONDITIONS	MIN	TYP	MAX	UNITS
LX Switch On-Resistance	V_+ = 9V, T_A = +25°C, MAX639/MAX640/MAX653		0.8	1.5	Ω
	V_+ = 6V, T_A = T_{MIN} to T_{MAX} , MAX639			2.5	
	V_+ = 4V, T_A = T_{MIN} to T_{MAX} , MAX640/MAX653			2.8	
LX Switch Leakage	V_+ = 11.5V, V_{LX} = 0V	T_A = +25°C	0.003	1.0	μA
		T_A = T_{MIN} to T_{MAX}		30.0	
VFB Bias Current	VFB = 2V		4.0	15.0	nA
VFB Dual-Mode Trip Point			50		mV
VFB Threshold	MAX6_ _C	1.26	1.28	1.30	V
	MAX6_ _E/M	1.24	1.28	1.32	
LBI Bias Current	V_{LBI} = 2V		2	10	nA
LBI Threshold	MAX6_ _C	1.26	1.28	1.30	V
	MAX6_ _E/M	1.24	1.28	1.32	
LBO Sink Current	V_{LBO} = 0.4V	MAX639	0.8	2.5	mA
		MAX640/MAX653	0.4	1.2	
LBO Leakage Current	V_{LBO} = 11.5V		0.001	0.1	μA
LBO Delay	50mV overdrive		25		μs
SHDN Threshold		0.80	1.15	2.00	V
SHDN Pull-Up Current	\overline{SHDN} = 0V	0.10	0.20	0.40	μA

Note 2: Output guaranteed by correlation to measurements of device parameters (i.e., switch on-resistance, on-times, off-times, and output voltage trip points).

Typical Operating Characteristics

(Circuit of Figure 3, internal feedback, L = 100 μH , T_A = +25°C, unless otherwise noted.)

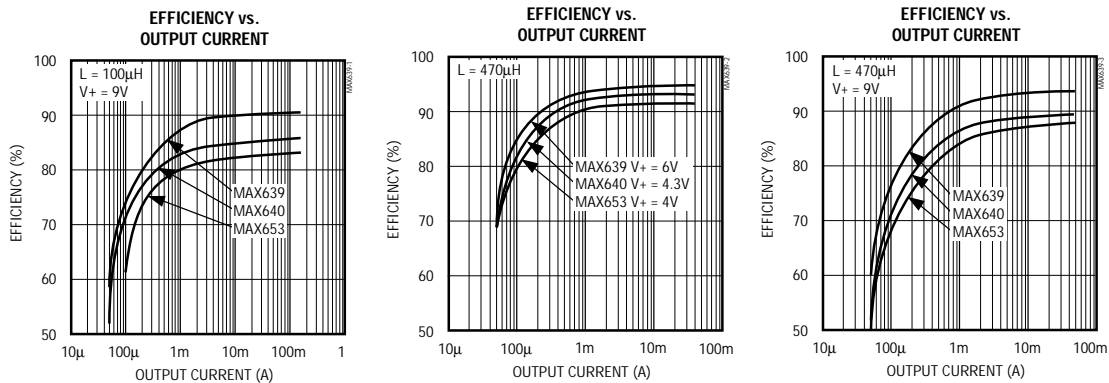

5V/3.3V/3V/Adjustable, High-Efficiency, Low I_Q , Step-Down DC-DC Converters

Typical Operating Characteristics (continued)

(Circuit of Figure 3, internal feedback, $L = 100\mu\text{H}$, $T_A = +25^\circ\text{C}$, unless otherwise noted.)

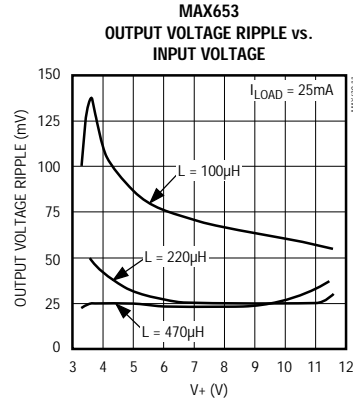
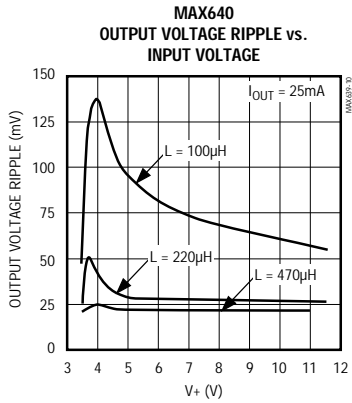
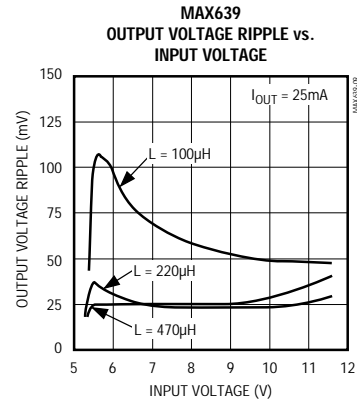
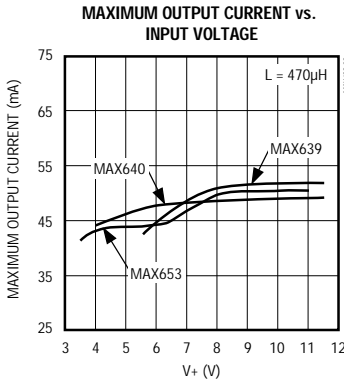
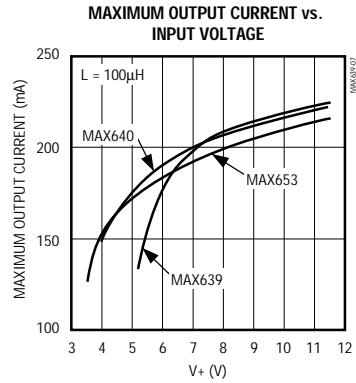
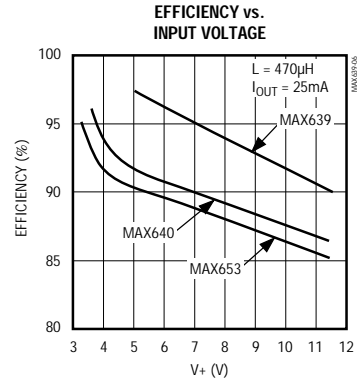
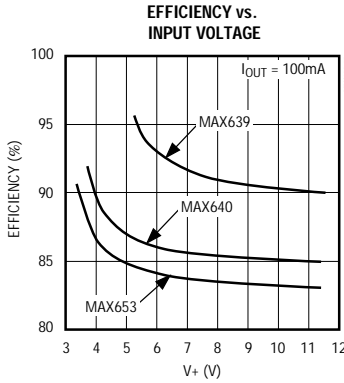
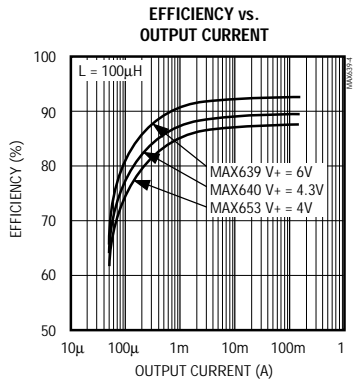

5V/3.3V/3V/Adjustable, High-Efficiency, Low I_Q , Step-Down DC-DC Converters

Typical Operating Characteristics (continued)

(Circuit of Figure 3, internal feedback, $L = 100\mu\text{H}$, $T_A = +25^\circ\text{C}$, unless otherwise noted.)

MAX639/MAX640/MAX653

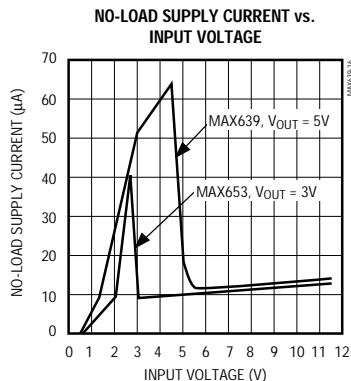
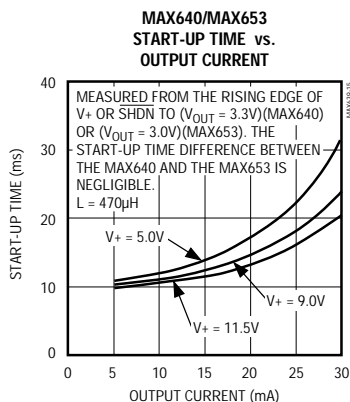
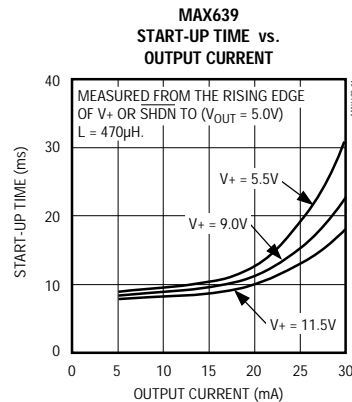
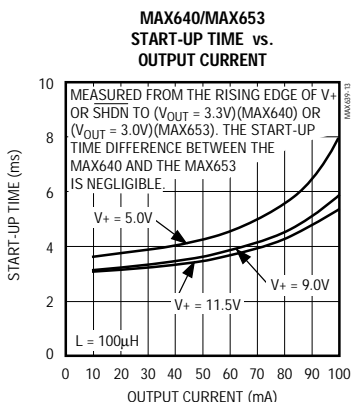
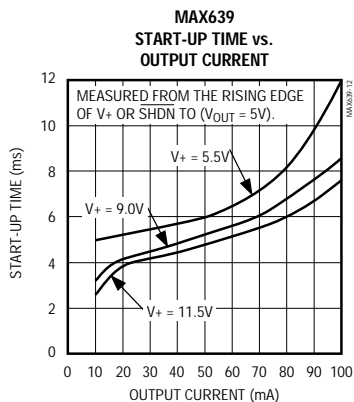

5V/3.3V/3V/Adjustable, High-Efficiency, Low I_Q , Step-Down DC-DC Converters

Typical Operating Characteristics (continued)

(Circuit of Figure 3, internal feedback, $L = 100\mu\text{H}$, $T_A = +25^\circ\text{C}$, unless otherwise noted.)

MAX653
LOAD-TRANSIENT RESPONSE

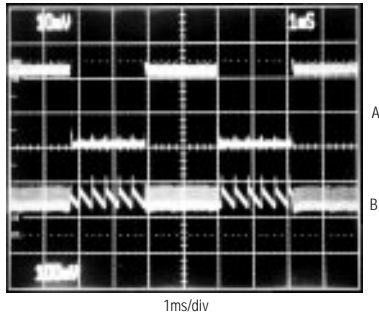

A: I_{LOAD} , 0mA TO 100mA, 50mA/div
 B: V_{OUT} , 100mV/div, AC COUPLED
 $V_{IN} = 5V$, $V_{OUT} = 3V$

MAX639
LOAD-TRANSIENT RESPONSE

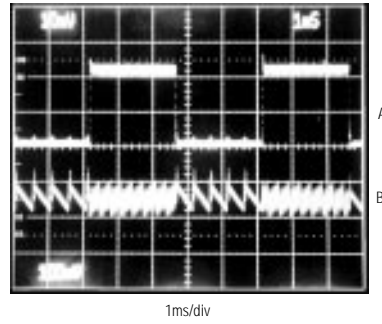

A: I_{LOAD} , 0mA TO 200mA, 100mA/div
 B: V_{OUT} , 100mV/div, AC COUPLED
 $V_{IN} = 9V$, $V_{OUT} = 5V$

MAX653
LINE-TRANSIENT RESPONSE

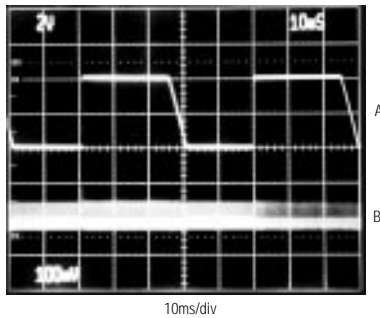

A: V_{IN} , 4V TO 8V, 2V/div
 B: V_{OUT} , 100mV/div
 $V_{OUT} = 3V$, $I_{LOAD} = 100\text{mA}$

MAX639
LINE-TRANSIENT RESPONSE

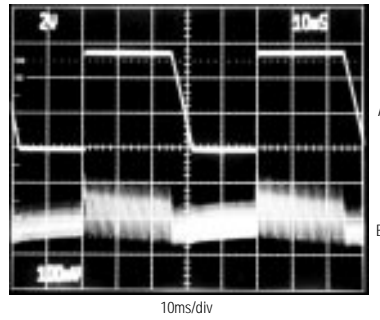

A: V_{IN} , 6V TO 11.5V, 2V/div
 B: V_{OUT} , 100mV/div
 $V_{OUT} = 5V$, $I_{LOAD} = 100\text{mA}$

5V/3.3V/3V/Adjustable, High-Efficiency, Low I_Q , Step-Down DC-DC Converters

Pin Description

MAX639/MAX640/MAX653

PIN	NAME	FUNCTION
1	VOUT	Sense Input for regulated-output operation. Internally connected to an on-chip voltage divider and to the variable duty-cycle, on-demand oscillator. It must be connected to the external regulated output.
2	LBO	Low-Battery Output. An open-drain N-channel MOSFET sinks current when the voltage at LBI drops below 1.28V.
3	LBI	Low-Battery Input. When the voltage at LBI drops below 1.28V, LBO sinks current.
4	GND	Ground
5	LX	Drain of a PMOS power switch that has its source connected to V+. LX drives the external inductor, which provides current to the load.
6	V+	Positive Supply-Voltage Input. Should not exceed 11.5V
7	VFB	Dual-Mode Feedback Pin. When VFB is grounded, the internal voltage divider sets the output to 5V (MAX639), 3.3V (MAX640) or 3V (MAX653). For adjustable operation, connect VFB to an external voltage divider.
8	SHDN	Shutdown Input — active low. When pulled below 0.8V, the LX power switch stays off, shutting down the regulator. When the shutdown input is above 2V, the regulator stays on. Tie SHDN to V+ if shutdown mode is not used.

Getting Started

Designing power supplies with the MAX639/MAX640/MAX653 is easy. The few required external components are readily available. The most general applications use the following components:

- (1) Capacitors: For the input and output filter capacitors, try using electrolytics in the 100 μ F range, or use low-ESR capacitors to minimize output ripple. Capacitor values are not critical.
- (2) Diode: Use the popular 1N5817 or equivalent Schottky diode.
- (3) Inductor: For the highest output current, choose a 100 μ H inductor with an incremental saturation current rating of at least 600mA. To obtain the highest efficiencies and smallest size, refer to the *Inductor Selection* section.

Detailed Description

Figure 1 shows a simplified, step-down DC-DC converter. When the switch is closed, a voltage equal to $(V_+ - V_{OUT})$ is applied to the inductor. The current through the inductor ramps up, storing energy in the inductor's magnetic field. This same current also flows into the output filter capacitor and load. When the switch opens, the current continues to flow through the inductor in the same direction, but must also flow through the diode. The inductor alone supplies current to the load when the switch is open. This current decays to zero as the energy stored in the inductor's magnetic field is transferred to the output filter capacitor and the load.

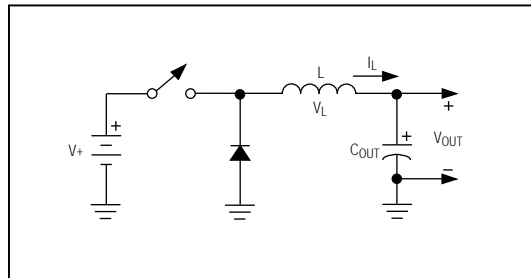

Figure 1. Simplified Step-Down Converter

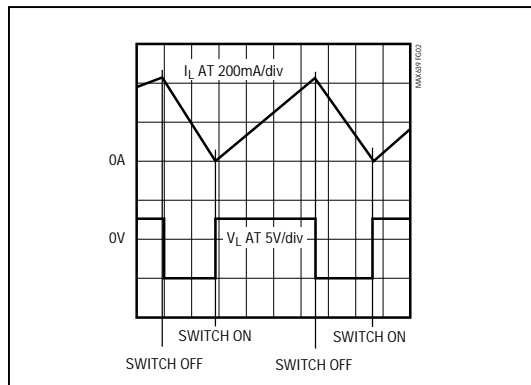

Figure 2. Simplified Step-Down Converter Operation

5V/3.3V/3V/Adjustable, High-Efficiency, Low I_Q , Step-Down DC-DC Converters

Figure 2 shows what happens to the ideal circuit of Figure 1 if the switch turns on with a 66% duty cycle and $V_+ = 3/2 V_{OUT}$. The inductor current rises more slowly than it falls because the magnitude of the voltage applied during t_{ON} is less than that applied during t_{OFF} . Varying the duty cycle and switching frequency keeps the peak current constant as input voltage varies. The MAX639/MAX640/MAX653 control the switch (t_{ON} and t_{OFF}) according to the following equations:

$$\text{Equation (1) } t_{ON} = 50\mu\text{sV} / (V_+ - V_{OUT})$$

$$\text{Equation (2) } t_{OFF} \geq 50\mu\text{sV} / V_{OUT}$$

$$\text{Equation (3) } I_{PEAK} = 50\mu\text{sV} / L$$

These three equations ensure constant peak currents for a given inductor value, across all input voltages (ignoring the voltage drop across the diode (D1) and the resistive losses in the switch and inductor). The variable duty cycle also ensures that the current through the inductor discharges to zero at the end of each pulse.

Figure 3 shows the MAX639/MAX640/MAX653 block diagram and a typical connection in which 9V is converted to 5V (MAX639), 3.3V (MAX640), or 3.0V (MAX653). The sequence of events in this application is as follows:

When the output dips:

- (1) The error comparator switches high.
- (2) The internal oscillator starts (15 μ s start-up time) and connects to the gate of the LX output driver.
- (3) LX turns on and off according to t_{ON} and t_{OFF} , charging and discharging the inductor, and supplying current to the output (as described above).

When the output voltage recovers:

- (1) The comparator switches low.
- (2) LX turns off.
- (3) The oscillator shuts down to save power.

Fixed or Adjustable Output

For operation at the preset output voltage, connect VFB to GND; no external resistors are required. For other output voltages, use an external voltage divider. Set the output voltage using R3 and R4 as determined by the following formula:

$$R3 = R4 [(V_{OUT} / V_{FB} \text{ Threshold}) - 1]$$

where R4 is any resistance in the 10k Ω to 1M Ω range (typically 100k Ω), and the VFB threshold is typically 1.28V.

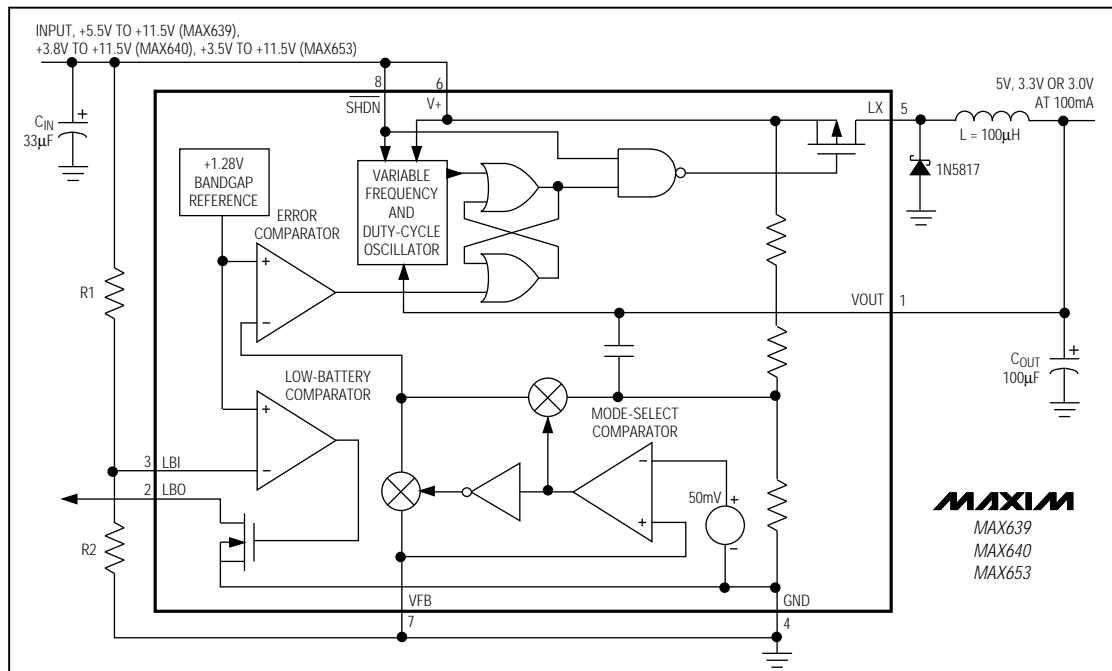

Figure 3. Block Diagram

5V/3.3V/3V/Adjustable, High-Efficiency, Low I_O, Step-Down DC-DC Converters

Low-Battery Detector

The low-battery detector compares the voltage on the LBI input with the internal 1.28V reference. LBO goes low whenever the input voltage at LBI is less than 1.28V. Set the low-battery detection voltage with resistors R1 and R2 (Figure 3) as determined by the following formula:

$$R1 = R2 [(VLB / LBI \text{ Threshold}) - 1]$$

where R2 is any resistance in the 10kΩ to 1MΩ range (typically 100kΩ), the LBI threshold is typically 1.28V, and VLB is the desired low-battery detection voltage.

The low-battery comparator remains active in shutdown mode.

Shutdown Mode

Bringing SHDN below 0.8V places the MAX639/MAX640/MAX643 in shutdown mode. LX becomes high impedance, and the voltage at VOUT falls to zero. The time required for the output to rise to its nominal regulated voltage when brought out of shutdown (start-up time) depends on the inductor value, input voltage, and load current (see the Start-Up Time vs. Output Current graph in the *Typical Operating Characteristics*). The low-battery comparator remains active in shutdown mode.

Applications Information

Inductor Selection

When selecting an inductor, consider these four factors: peak-current rating, inductance value, series resistance, and size. It is important not to exceed the inductor's peak-current rating. A saturated inductor will pull excessive currents through the MAX639/MAX640/MAX653's switch, and may cause damage. Avoid using RF chokes or air-core inductors since they have very low peak-current ratings. Electromagnetic interference must not upset nearby circuitry or the regulator IC. Ferrite-bobbin types work well for most digital circuits; toroids or pot cores work well for EMI-sensitive analog circuits.

Recall that the inductance value determines I_{PEAK} for all input voltages (Equation 3). If there are no resistive losses and the diode is ideal, the maximum average current that can be drawn from the MAX639/MAX640/MAX653 will be one-half I_{PEAK}. With the real losses in the switch, inductor, and diode taken into account, the real maximum output current typically varies from 90% to 50% of the ideal. The following steps describe a conservative way to pick an appropriate inductor.

Step 1: Decide on the maximum required output current, in amperes: I_{OUTMAX}.

Step 2: I_{PEAK} = 4 x I_{OUTMAX}.

Table 1. Component Suppliers

INDUCTORS — THROUGH HOLE				
PART NUMBER	SIZE (inches)	VALUE (μH)	I _{MAX} (A)	SERIES R (Ω)
MAXL001*	0.65 x 0.33 dia.	100	1.75	0.2
7300-13**	0.63 x 0.26 dia.	100	0.89	0.27
7300-15**	0.63 x 0.26 dia.	150	0.72	0.36
7300-17**	0.63 x 0.26 dia.	220	0.58	0.45
7300-19**	0.63 x 0.26 dia.	330	0.47	0.58
7300-21**	0.63 x 0.26 dia.	470	0.39	0.86
7300-25**	0.63 x 0.26 dia.	1000	0.27	2.00
* Maxim Integrated Products **Caddell-Burns 258 East Second Street Mineola, NY 11501-3508 (516) 746-2310				
INDUCTORS — SURFACE MOUNT				
PART NUMBER	SIZE (mm)	VALUE (μH)	I _{MAX} (A)	SERIES R (Ω)
CD54	5.2 x 5.8 x 4.5	100	0.52	0.63
CD54	5.2 x 5.8 x 4.5	220	0.35	1.50
CDR74	7.1 x 7.7 x 4.5	100	0.52	0.51
CDR74	7.1 x 7.7 x 4.5	220	0.35	0.98
CDR105	9.2 x 10.0 x 5.0	100	0.80	0.35
CDR105	9.2 x 10.0 x 5.0	220	0.54	0.69
Sumida Electric (USA) 637 East Golf Road Arlington Heights, IL 60005 (708) 956-0666				
CAPACITORS — LOW ESR				
PART NUMBER	SIZE (inches)	VALUE (μF)	ESR (Ω)	V _{MAX} (V)
MAXC001*	0.49 x 0.394 dia.	150	0.2	35
267 Series**	D SM packages	47	0.2	10
267 Series**	E SM packages	100	0.2	6.3
* Maxim Integrated Products **Matsuo Electronics 2134 Main Street Huntington Beach, CA 92648 (714) 969-2491				
SCHOTTKY DIODES — SURFACE MOUNT				
PART NUMBER	SIZE	V _F (V)	I _{MAX} (A)	
SE014	SOT89	0.55	1	
SE024	SOT89	0.55	0.95	
Collmer Semiconductor 14368 Proton Road Dallas, TX 75244 (214) 233-1589 NOTE: This list does not constitute an endorsement by Maxim Integrated Products and is not intended to be a comprehensive list of all manufacturers of these components.				

MAX639/MAX640/MAX653

5V/3.3V/3V/Adjustable, High-Efficiency, Low I_Q , Step-Down DC-DC Converters

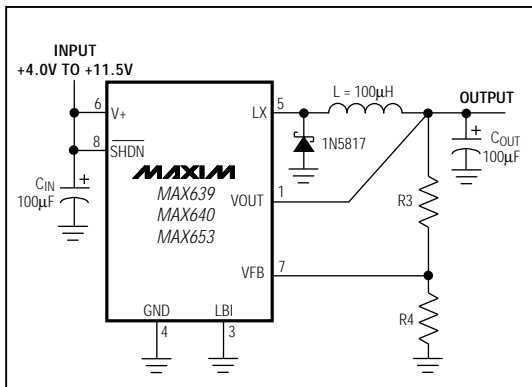

Figure 4. Adjustable-Output Operation

Step 3: $L = 50 / I_{PEAK}$. L will be in μH . Do not use an inductor of less than $100\mu\text{H}$.

Step 4: Make sure that I_{PEAK} does not exceed 0.6A or the inductor's maximum current rating, whichever is lower.

Inductor series resistance affects both efficiency and dropout voltage. A high series resistance severely limits the maximum current available at lower input voltages. Output currents up to 225mA are possible if the inductor has low series resistance. Inductor and series switch resistance form an LR circuit during t_{ON} . If the L/R time constant is less than the oscillator t_{ON} , the inductor's peak current will fall short of the desired I_{PEAK} .

To maximize efficiency, choose the highest-value inductor that will provide the required output current over the whole range of your input voltage (see *Typical Operating Characteristics*). Inductors with peak currents in the 600mA range do not need to be very large. They are about the size of a 1W resistor, with surface-mount versions less than 5mm in diameter. Table 1 lists suppliers of inductors suitable for use with the MAX639/MAX640/MAX653.

Output Filter Capacitor

The MAX639/MAX640/MAX653's output ripple has two components. One component results from the variation in stored charge on the filter capacitor with each LX pulse. The other is the product of the current into the capacitor and the capacitor's equivalent series resistance (ESR).

The amount of charge delivered in each oscillator pulse is determined by the inductor value and input voltage.

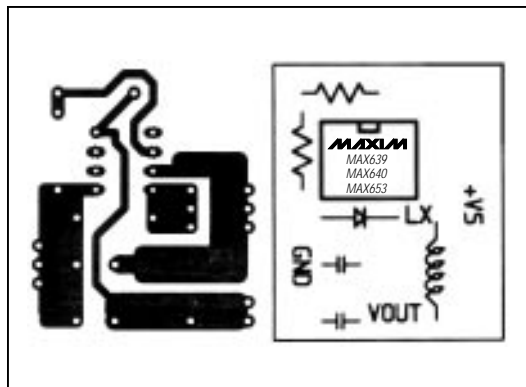

Figure 5. Through-Hole PC Layout and Component Placement Diagram for Standard Step-Down Application (Top-Side View)

It decreases with larger inductance, but increases as the input voltage lessens. As a general rule, a smaller amount of charge delivered in each pulse results in less output ripple.

With low-cost aluminum electrolytic capacitors, the ESR-induced ripple can be larger than that caused by the charge variation. Consequently, high-quality aluminum-electrolytic or tantalum filter capacitors will minimize output ripple. Best results at reasonable cost are typically achieved with an aluminum-electrolytic capacitor in the $100\mu\text{F}$ range, in parallel with a $0.1\mu\text{F}$ ceramic capacitor (Table 1).

External Diode

In most MAX639/MAX640/MAX653 circuits, the current in the external diode (D1, Figure 3) changes abruptly from zero to its peak value each time LX switches off. To avoid excessive losses, the diode must have a fast turn-on time. For low-power circuits with peak currents less than 100mA , signal diodes such as the 1N4148 perform well. The 1N5817 diode works well for high-power circuits, or for maximum efficiency at low power. 1N5817 equivalent diodes are also available in surface-mount packages (Table 1). Although the 1N4001 and other general-purpose rectifiers are rated for high currents, they are unacceptable because their slow turn-off times result in excessive losses.

Minimum Load

Under no-load conditions, because of leakage from the PMOS power switch (see the LX Leakage Current vs. Temperature graph in the *Typical Operating Characteristics*) and from the internal resistor from $V+$ to V_{OUT} , leakage current may be supplied to the output

5V/3.3V/3V/Adjustable, High-Efficiency, Low I_Q , Step-Down DC-DC Converters

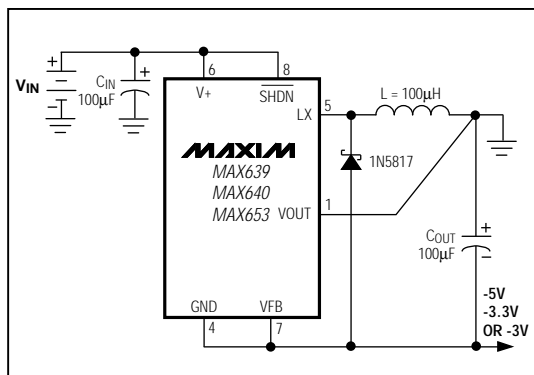

Figure 6. Inverting Configuration

capacitor, even when the switch is off. This will usually not be a problem for a 5V output at room temperature, since the diode's reverse leakage current and the feedback resistors' current typically drain the excess. However, if the diode leakage is very low (which can occur at low temperatures and/or small output voltages), charge may build up on the output capacitor, making V_{OUT} rise above its set point. If this happens, add a small load resistor (typically $1M\Omega$) to the output to pull a few extra microamps of current from the output capacitor.

Layout

Several of the external components in a MAX639/MAX640/MAX653 circuit experience peak currents up to 600mA. Wherever one of these components connects to ground, there is a potential for ground bounce. Ground bounce occurs when high currents flow through the parasitic resistances of PC board traces. What one component interprets as ground can differ from the IC's ground by several millivolts. This may increase the MAX639/MAX640/MAX653's output ripple, since the error comparator (which is referenced to ground) will generate extra switching pulses when they are not needed. It is essential that the input filter capacitor's ground lead, the MAX639/MAX640/MAX653's GND pin, the diode's anode, and the output filter capacitor's ground lead are as close together as possible, preferably at the same point. Figure 5 shows a suggested through-hole printed circuit layout that minimizes ground bounce.

Inverter Configuration

Figure 6 shows the MAX639/MAX640/MAX653 in a floating ground configuration. By tying what would normally be the output to the supply-voltage ground, the IC's GND pin is forced to a regulated -5V

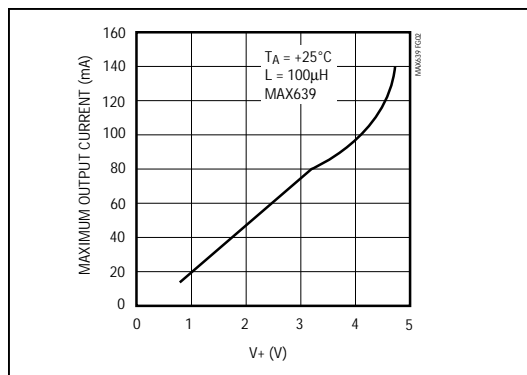

Figure 7. Maximum Current Capability of Figure 6 Circuit

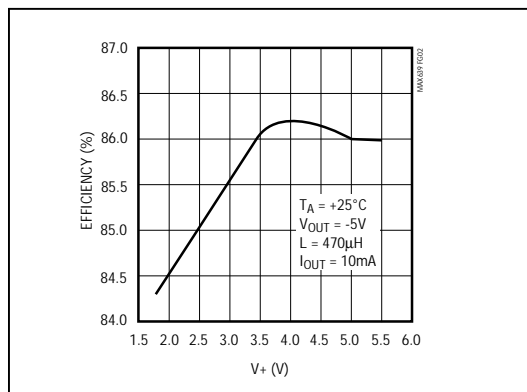

Figure 8. Efficiency of Figure 6 Circuit

(MAX639), -3.3V (MAX640), or -3V (MAX653). Avoid exceeding the maximum differential voltage of 11.5V from V_+ to V_{OUT} . Other negative voltages can be generated by placing a voltage divider across C_{OUT} and connecting the tap point to VFB in the same manner as the normal step-down configuration.

Two AA Batteries to 5V, 3.3V, or 3V

For battery-powered applications, where the signal ground does not have to correspond to the power-supply ground, the circuit in Figure 6 generates 5V (MAX639), 3.3V (MAX640), or 3V (MAX653) from a pair of AA batteries. Connect the V_{IN} ground point to your system's input, and connect the output to your system's ground input. This configuration has the added advantage of reduced on-resistance, since the IC's internal power FET has $V_{IN} + V_{OUT}$ of gate drive (Figures 7 and 8).

MAX639/MAX640/MAX653

5V/3.3V/3V/Adjustable, High-Efficiency, Low I_Q, Step-Down DC-DC Converters

Ordering Information (continued)

PART	TEMP. RANGE	PIN-PACKAGE
MAX640CPA	0°C to +70°C	8 Plastic DIP
MAX640CSA	0°C to +70°C	8 SO
MAX640C/D	0°C to +70°C	Dice*
MAX640EPA	-40°C to +85°C	8 Plastic DIP
MAX640ESA	-40°C to +85°C	8 SO
MAX640MJA	-55°C to +125°C	8 CERDIP
MAX653CPA	0°C to +70°C	8 Plastic DIP
MAX653CSA	0°C to +70°C	8 SO
MAX653C/D	0°C to +70°C	Dice*
MAX653EPA	-40°C to +85°C	8 Plastic DIP
MAX653ESA	-40°C to +85°C	8 SO
MAX653MJA	-55°C to +125°C	8 CERDIP

* Contact factory for dice specifications.

Chip Topography

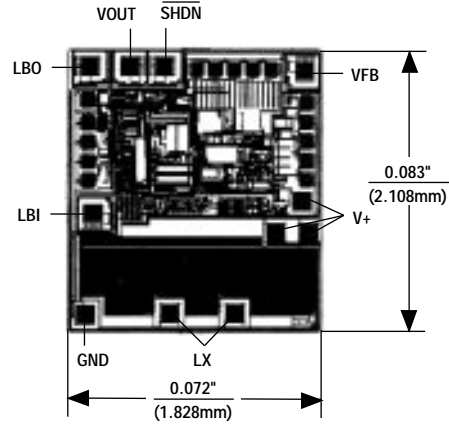

TRANSISTOR COUNT: 221
SUBSTRATE CONNECTED TO V+

Package Information

DIM	INCHES		MILLIMETERS	
	MIN	MAX	MIN	MAX
A	0.053	0.069	1.35	1.75
A1	0.004	0.010	0.10	0.25
B	0.014	0.019	0.35	0.49
C	0.007	0.010	0.19	0.25
D	0.189	0.197	4.80	5.00
E	0.150	0.157	3.80	4.00
e	0.050 BSC		1.27 BSC	
H	0.228	0.244	5.80	6.20
h	0.010	0.020	0.25	0.50
L	0.016	0.050	0.40	1.27
α	0°	8°	0°	8°

21-325A

**8-PIN PLASTIC
SMALL-OUTLINE
PACKAGE**

Maxim cannot assume responsibility for use of any circuitry other than circuitry entirely embodied in a Maxim product. No circuit patent licenses are implied. Maxim reserves the right to change the circuitry and specifications without notice at any time.

12 Maxim Integrated Products, 120 San Gabriel Drive, Sunnyvale, CA 94086 (408) 737-7600

© 1994 Maxim Integrated Products

Printed USA

MAXIM is a registered trademark of Maxim Integrated Products.