

Technical Data

MRFIC0970/D
Rev. 0, 07/2002

3.2 V GSM GaAs
Integrated Power
Amplifier



MRFIC0970



(Scale 2:1)

Package Information

Plastic Package
Case 1308
(QFN-20)

Ordering Information

Device	Marking	Package
MRFIC0970	0970	QFN-20

The MRFIC0970 is a single supply, RF power amplifier designed for the 2.0 W GSM900 handheld radios. The device is packaged in the QFN-20 package, with exposed backside pad, which allows excellent electrical and thermal performance through a solderable contact.

- Target 3.2 V Characteristics:
 - RF Output Power: 34.5 dBm Typical
 - Efficiency: 50% Typical
- Single Positive Supply Solution
- Available in Tape and Reel only. R2 Suffix = 2500 Units per 12 mm, 13 inch Reel

Table 3. Electrical Specifications

($V_{D1,2,3} = 3.2$ V, $V_{abc} = 2.6$ V, $P_{in} = 5.0$ dBm, Peak measurement at 12.5% duty cycle, 4.6 ms period, $T_A = 25^\circ\text{C}$, unless otherwise noted.)

Characteristic	Symbol	Min	Typ	Max	Unit
Frequency Range	BW	880	-	915	MHz
Output Power	P_{out}	34.5	-	-	dBm
Power Added Efficiency	PAE	50	-	-	%
Minimum Output Power ($V_{ref} = 0.04$, $V_{abc} = 2.6$ V)		-	-	-17	dBm
Power Control Slope ($V_{ref} = 0.1$ to 1.8 V, $\Delta V_{ref} = 0.01$ V)		-	-	50:1	$\frac{RFV_{rms}}{V_{ref}}$
Bleed thru Power ($P_{in(f_o)} \leq -12$ dBm, $V_{ref} = 0.04$, $V_{abc} = 10$ k load)		-	-	-36	dBm
RF Leakage Current ($I_{DD1} + I_{DD2} + I_{DD3}$, $P_{in}(f_o) \leq 5.0$ dBm) ($V_{abc} = 10$ k load, $V_{ref} = 0.04$ V)		-	-	35	mA
Output Power Switching Speed (\pm step input of V_{ref} RF P_{out} within 1.0 dB of final value)		-	-	1.0	μs
Input Return Loss	S11	-	-	6.0	dB
Noise Power in Rx band 925 to 935 MHz 935 to 960 MHz	NP	-	-	-73 -85	dBm
Stability-Spurious Output (Load VSWR 6:1 all phase angles, Adjust $V_{D1, 2\&3}$ for specified power)	P_{spur}	-	-	-30	dBc
Load Mismatch Stress (Load VSWR = 10:1 all phase angles, 5 seconds, Adjust $V_{D1, 2\&3}$ for specified power)	No Degradation in Output Power Before & After Test				

2 Pin Connections

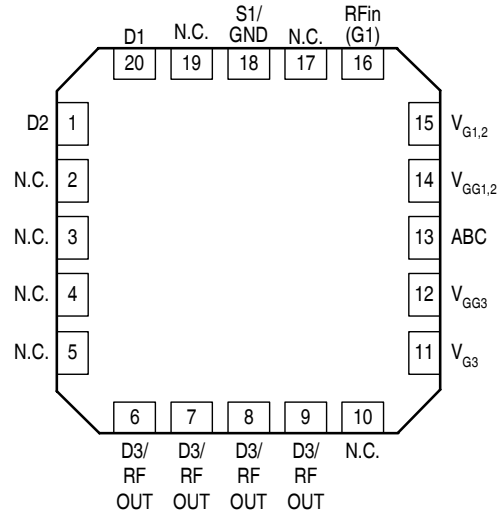

Figure 2. Pin Connections

3 Typical Performance Characteristics

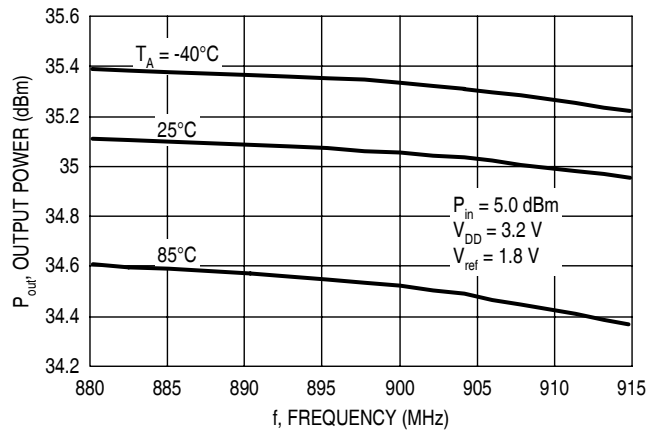

Figure 3. Output Power versus Frequency

Typical Performance Characteristics

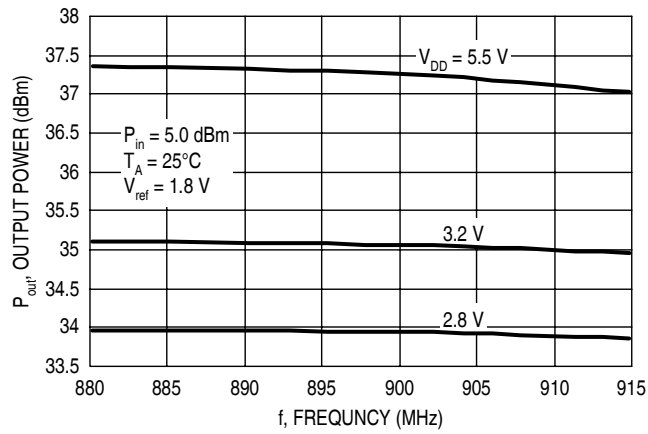

Figure 4. Output Power versus Frequency

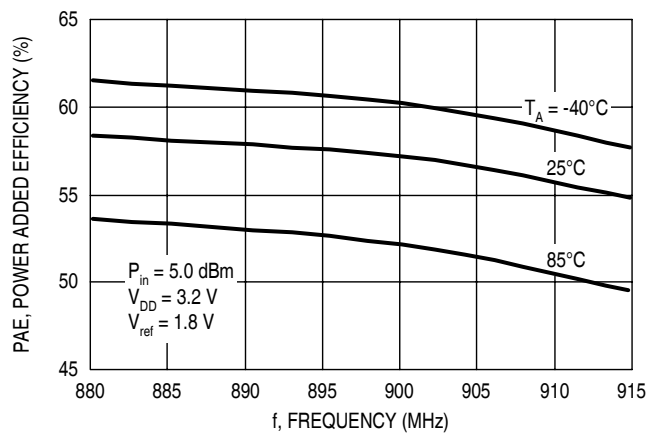

Figure 5. Power Added Efficiency versus Frequency

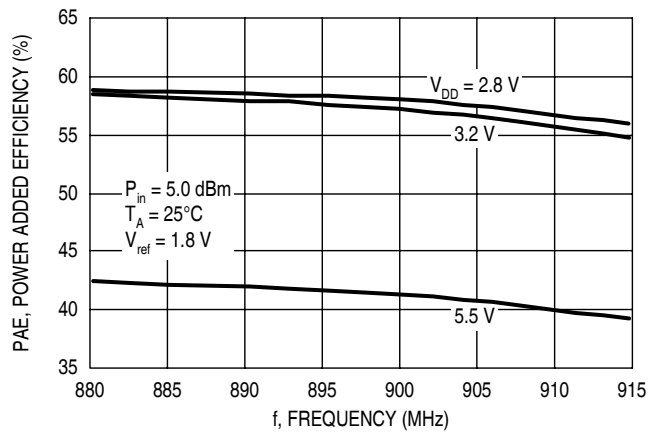

Figure 6. Power Added Efficiency versus Frequency

4 Application Schematic

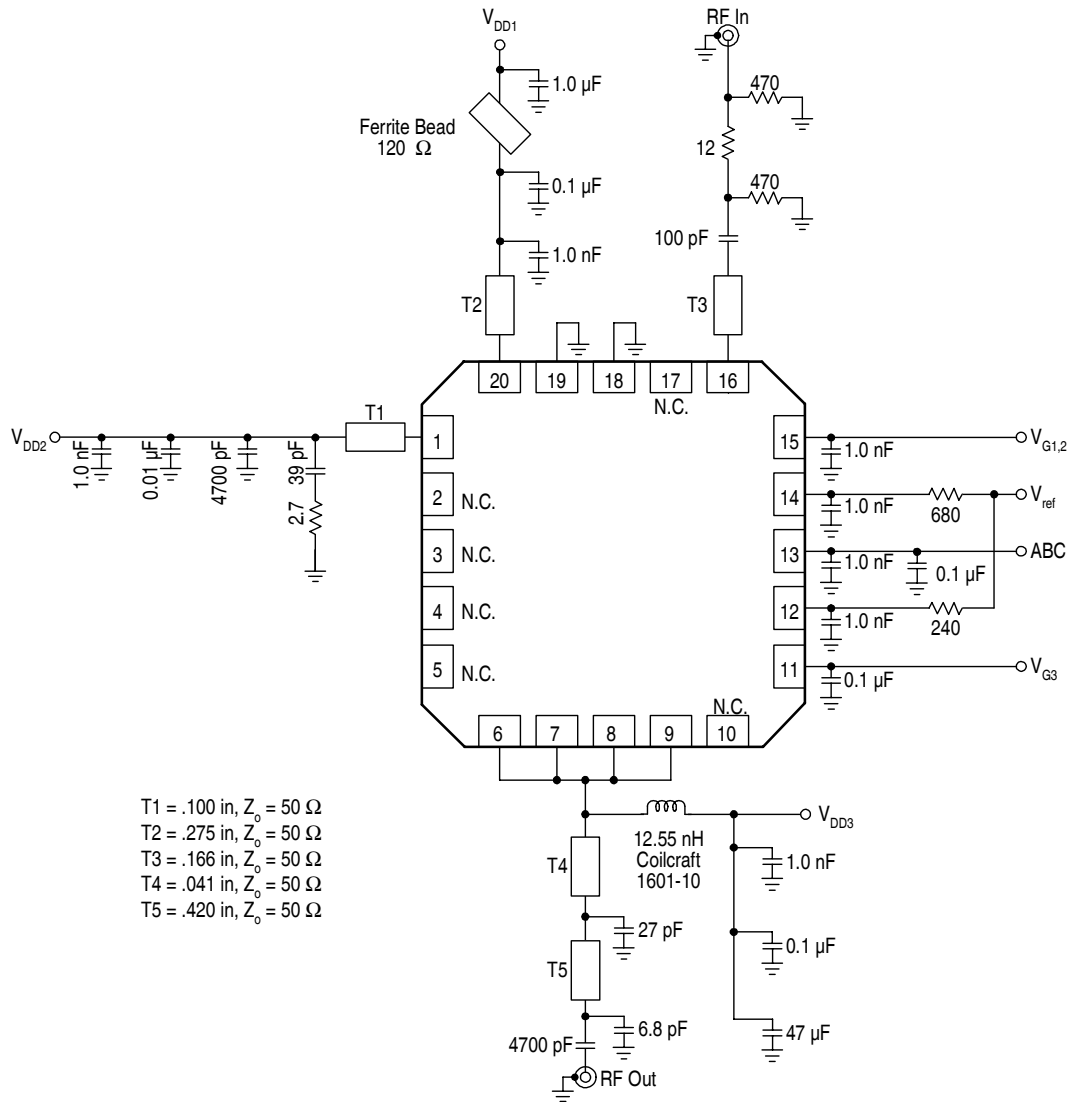
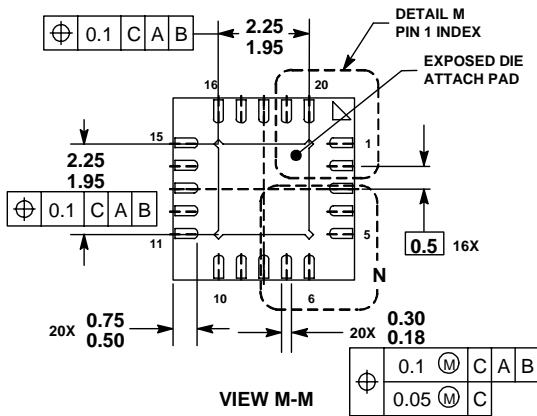
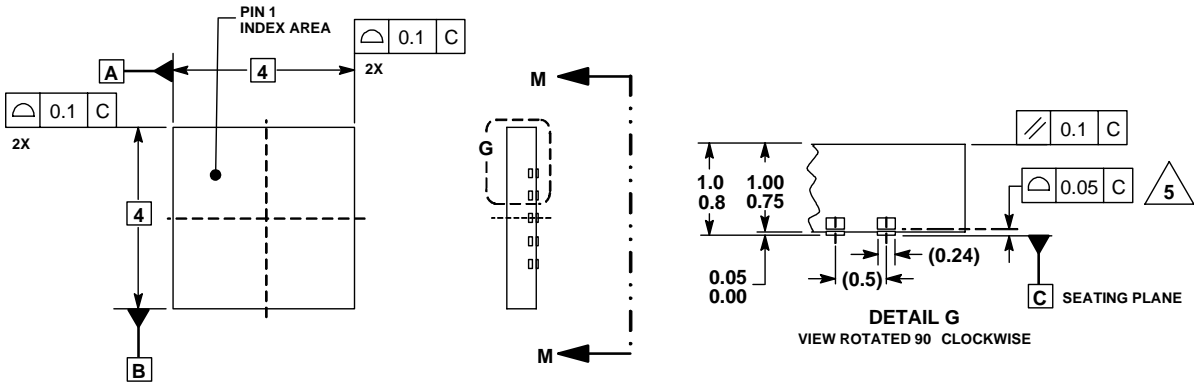

Figure 7. Application Schematic

5 Packaging



- NOTES:
1. DIMENSIONS ARE IN MILLIMETERS.
 2. DIMENSIONS AND TOLERANCES PER ASME Y14.5M, 1994.
 3. THE COMPLETE JEDEC DESIGNATOR FOR THIS PACKAGE IS: HF-PQFP-N.
 4. CORNER CHAMFER MAY NOT BE PRESENT. DIMENSIONS OF OPTIONAL FEATURES ARE FOR REFERENCE ONLY. COPLANARITY APPLIES TO LEADS, CORNER LEADS, AND DIE ATTACH PAD.
 7. FOR ANVIL SINGULATED QFN PACKAGES, MAXIMUM DRAFT ANGLE IS 12 .

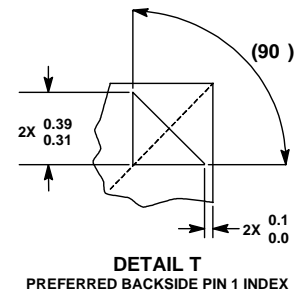
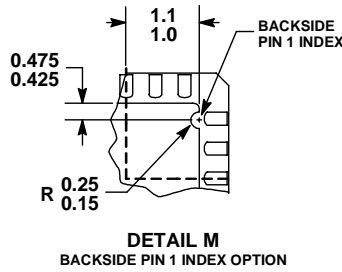
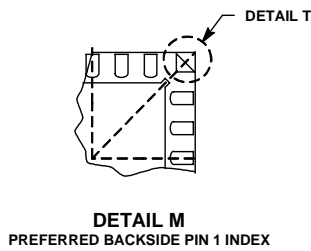
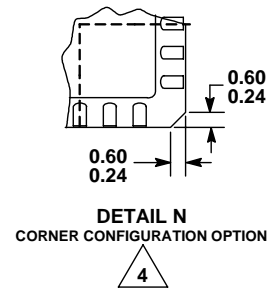
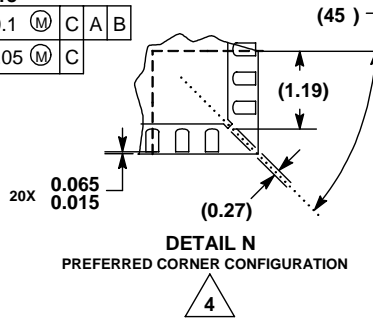

Figure 8. Outline Dimensions for QFN-20 (Case 1308-02, Issue C)

HOW TO REACH US:**USA/EUROPE/LOCATIONS NOT LISTED:**

Motorola Literature Distribution;
P.O. Box 5405, Denver, Colorado 80217
1-303-675-2140 or 1-800-441-2447

JAPAN:

Motorola Japan Ltd.; SPS, Technical Information Center,
3-20-1, Minami-Azabu Minato-ku, Tokyo 106-8573 Japan
81-3-3440-3569

ASIA/PACIFIC:

Motorola Semiconductors H.K. Ltd.; Silicon Harbour
Centre, 2 Dai King Street, Tai Po Industrial Estate,
Tai Po, N.T., Hong Kong
852-26668334

TECHNICAL INFORMATION CENTER:

1-800-521-6274

HOME PAGE:

<http://www.motorola.com/semiconductors>

Information in this document is provided solely to enable system and software implementers to use Motorola products. There are no express or implied copyright licenses granted hereunder to design or fabricate any integrated circuits or integrated circuits based on the information in this document.

Motorola reserves the right to make changes without further notice to any products herein. Motorola makes no warranty, representation or guarantee regarding the suitability of its products for any particular purpose, nor does Motorola assume any liability arising out of the application or use of any product or circuit, and specifically disclaims any and all liability, including without limitation consequential or incidental damages. Typical parameters which may be provided in Motorola data sheets and/or specifications can and do vary in different applications and actual performance may vary over time. All operating parameters, including typicals must be validated for each customer application by customer's technical experts. Motorola does not convey any license under its patent rights nor the rights of others. Motorola products are not designed, intended, or authorized for use as components in systems intended for surgical implant into the body, or other applications intended to support or sustain life, or for any other application in which the failure of the Motorola product could create a situation where personal injury or death may occur. Should Buyer purchase or use Motorola products for any such unintended or unauthorized application, Buyer shall indemnify and hold Motorola and its officers, employees, subsidiaries, affiliates, and distributors harmless against all claims, costs, damages, and expenses, and reasonable attorney fees arising out of, directly or indirectly, any claim of personal injury or death associated with such unintended or unauthorized use, even if such claim alleges that Motorola was negligent regarding the design or manufacture of the part.



Motorola and the Stylized M Logo are registered in the U.S. Patent and Trademark Office. All other product or service names are the property of their respective owners. Motorola, Inc. is an Equal Opportunity/Affirmative Action Employer.

© Motorola, Inc. 2002

MRFIC0970/D