

MAXIM

10 Volt Precision References

MX2700/2701/2710

General Description

The MX2700 series of precision 10 volt reference sources offers excellent accuracy and stability. Laser trimming of both initial accuracy and temperature drift ensures high precision over the commercial (0°C to +70°C), industrial (-25°C to +85°C) and military (-55°C to +125°C) temperature ranges. The guaranteed absolute accuracy allows the user to configure systems without the need for ovens or chip heaters for temperature regulation. The MX2700 is a +10 volt output reference while the MX2701 is a -10 volt output. Both devices are guaranteed to 3ppm/°C max with 2.5mV initial accuracy. The MX2710, with a +10 volt output, is guaranteed to 1ppm/°C max with 1mV initial accuracy. These products are designed to interface with high accuracy, high resolution A to D and D to A converters, precision instrumentation, and data acquisition systems.

Applications

Precision D/A and A/D Converter Reference
 Digital Voltmeters
 Precision Test and Measurement Systems
 Precision Calibrated Voltage Reference Standard
 High Accuracy Transducers

Typical Operating Circuit

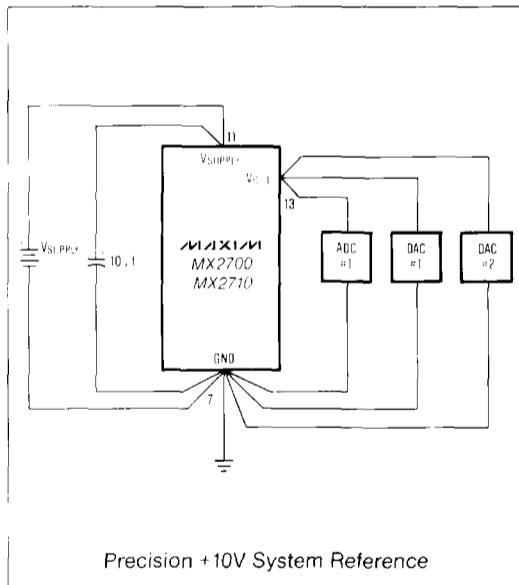

Features

- ◆ Pin-for-Pin 2nd Source!
- ◆ Excellent Initial Accuracy
- ◆ Low Temperature Coefficient
- ◆ Excellent Long-Term Stability, 50ppm/1000hrs.
- ◆ 10mA Output Current Capability
- ◆ Superior Line Regulation: 100μV/V max.
- ◆ Standard Ceramic Side Brazed DIP

Ordering Information

PART	OUTPUT VOLTAGE	TEMP. RANGE
MX2700JD	-10V, 10 ppm/°C	-25°C to +85°C
MX2700LD	+10V, 3 ppm/°C	-25°C to +85°C
MX2700SD	+10V, 3 ppm/°C	-55°C to +125°C
MX2700UD	+10V, 3 ppm/°C	-55°C to +125°C
MX2701JD	-10V, 10 ppm/°C	-25°C to +85°C
MX2701LD	-10V, 3 ppm/°C	-25°C to +85°C
MX2701SD	-10V, 3 ppm/°C	-55°C to +125°C
MX2701UD	-10V, 3 ppm/°C	-55°C to +125°C
MX2710LD	+10V, 1 ppm/°C	0°C to +70°C
MX2710KD	+10V, 2 ppm/°C	0°C to +70°C

All devices are available in a 14 lead ceramic side brazed DIP.

Pin Configuration

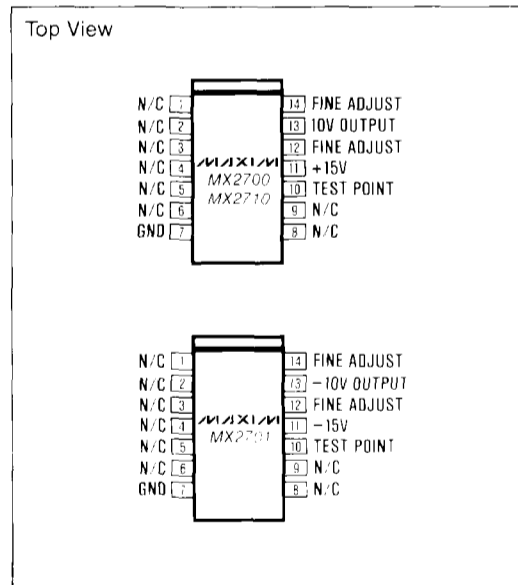

MX2700/2701/2710

10 Volt Precision References

ABSOLUTE MAXIMUM RATINGS

Input Voltage	+20V	Storage Temperature	65°C to -160°C
Power Dissipation	400mW	Lead Temperature (soldering, 10 seconds)	+300°C
Operating Temperature Range		Short Circuit to GND	Continuous
MX2700JD, LD, MX2701JD, LD	-25°C to +85°C		
MX2700SD, UD, MX2701SD, UD	-55°C to +125°C		
MX2710KD, LD	0°C to +70°C		

Stresses above those listed under "Absolute Maximum Ratings" may cause permanent damage to the device. These are stress ratings only, and functional operation of the device at these or any other conditions above those indicated in the operational sections of the specifications is not implied. Exposure to absolute maximum rating conditions for extended periods may affect device reliability.

ELECTRICAL CHARACTERISTICS

($V_{IN} = +15V$ for MX2700 and MX2710, $V_{IN} = -15V$ for MX2701, $T_A = +25^\circ C$, $R_L = 2k\Omega$, unless otherwise noted)

PARAMETER	CONDITIONS	MIN.	TYP.	MAX.	UNITS
Initial Output Voltage	MX2700JD, SD	9.9950	10.0000	10.0050	V
	MX2700LD, UD	9.9975	10.0000	10.0025	V
	MX2701JD, SD	-10.0050	-10.0000	-9.9950	V
	MX2701LD, UD	-10.0025	-10.0000	-9.9975	V
	MX2710KD, LD	9.9990	10.0000	10.0010	V
Output Voltage Drift	MX2700.01JD	$T_A = T_{MIN}$ to T_{MAX}		10	ppm/°C
	MX2700.01LD, SD, UD	$T_A = T_{MIN}$ to T_{MAX}		3	ppm/°C
	MX2710KD	$T_A = +25^\circ C$ to $+70^\circ C$		2	ppm/°C
	MX2710LD	$T_A = +25^\circ C$ to $+70^\circ C$		1	ppm/°C
	MX2710KD	$T_A = 0^\circ C$ to $-25^\circ C$		5	ppm/°C
	MX2710LD	$T_A = 15^\circ C$ to $+25^\circ C$		2	ppm/°C
Output Voltage Range	MX2700JD, MX2701JD	$T_A = T_{MIN}$ to T_{MAX}		±11.0	mV
	MX2700LD, MX2701LD	$T_A = T_{MIN}$ to T_{MAX}		±4.3	mV
	MX2700SD, MX2701SD	$T_A = T_{MIN}$ to T_{MAX}		±8.0	mV
	MX2700UD, MX2701UD	$T_A = T_{MIN}$ to T_{MAX}		±5.5	mV
Output Current	$T_A = 25^\circ C$, for Specified Load Regulation			10	mA
	$T_A = T_{MIN}$ to T_{MAX} $V_{IN} = +13V$ to $+18V$ (MX2700, 2710) $V_{IN} = -13V$ to $-18V$ (MX2701)			5	mA
Line Regulation	$V_{IN} = -13.5V$ to $+16.5V$ (MX2700, 2710)			100	$\mu V/V$
	$V_{IN} = -13.5V$ to $-16.5V$ (MX2701)			100	$\mu V/V$
Load Regulation	0 to 10mA to GND			50	$\mu V/mA$
Output Resistance	0 to 10mA to GND			0.05	Ω
Input Voltage Range	MX2700, MX2710	+13		-18	V
	MX2701	-13		-18	V
Quiescent Current	No Load		9	14	mA
Noise (Note 1)	0.1 to 10Hz		6	50	μV_{RMS}
Long Term Stability	$T_A = +55^\circ C$		50		ppm/1000 hrs
Output Adjust Range	See Figure 1 and 2		±20		mV
Output Adjust Temperature Drift Effect			±4		$\mu V/^\circ C$ per mV of adjust

Note 1: QA sample tested.

10 Volt Precision References

Theory of Operation

A zener voltage of approximately 6.3V is applied to the non-inverting input of an operational amplifier. This voltage is accurately amplified to produce a precise 10.000V output. The amplifier's gain setting resistors are actively laser-trimmed to produce the desired output voltage. The zener operating current is derived from the regulated output voltage, and actively laser-trimmed to produce the lowest drift over temperature at the output of the amplifier.

Discussion of Performance

The Maxim MX2700 and MX2701 are designed for applications requiring a precision voltage reference, where initial accuracy at room temperature and drift over temperature are of prime importance.

The drift specification of the MX2700 and MX2701 are guaranteed by making precise voltage measurements at -55°C, -25°C, +25°C, +85°C, and -125°C, while maintaining unit identity. In this way, three key specifications are guaranteed: initial accuracy, absolute accuracy over temperature, and drift. The upper and lower bound limits of absolute accuracy over temperature are established by the sum of the maximum initial output voltage error and the maximum drift from +25°C to T_{MAX}. For example, the MX2700LD limit of 4.3mV is calculated from the addition of 2.5mV initial output voltage error plus the temperature drift error of 1.8mV [3ppm/°C x 10V x (85°C - 25°C)].

The drift specification is defined using the "box method" (Fig. 3). The "box" is formed by the T_{MAX} and T_{MIN} temperatures and a diagonal with a slope equal to the maximum specified drift. The maximum and minimum output voltages must meet the following conditions:

$$\frac{(V_{OUTMAX} - V_{OUTMIN})/10V}{T_{MAX} - T_{MIN}} \times 10^6 < \text{drift specification}$$

This assures that the output voltage variation over the temperature change is contained within the box with V_{OUTMAX} and V_{OUTMIN} limits.

For example, the MX2700LD maximum drift specification of 3ppm/°C from -25°C to +85°C restricts (V_{OUTMAX} - V_{OUTMIN}) to less than 3.3mV.

The MX2710 drift specification is defined over the temperature range of 0°C to +70°C using the "butterfly" method (Fig. 4), where endpoint measurements are tested for temperature coefficient from 25°C independent of the nominal voltage. Each device is tested at 0°C, +15°C, +25°C, and +70°C with the output voltage data recorded at each temperature. After the initial accuracy is checked for 1mV deviation from +10.000V at +25°C, the devices are graded according to temperature coefficient (TC). The MX2710K has a temperature coefficient less than or equal to 2ppm/°C from +25°C to

+70°C and 5ppm/°C from 0°C to +25°C. These temperature coefficients correspond to a maximum change of 0.90mV and 1.25mV respectively (see Fig. 4a).

$$10V \times (70^\circ\text{C} - 25^\circ\text{C}) \times 2 \times 10^{-6} = 0.90\text{mV}$$

$$10V \times (25^\circ\text{C} - 0^\circ\text{C}) \times 5 \times 10^{-6} = 1.25\text{mV}$$

Similarly, the MX2710L is tested for 1ppm/°C from +25°C to +70°C, 2ppm/°C from +15°C to +25°C, and 5ppm/°C from 0°C to +15°C (see Fig. 4b). The corresponding voltage limits are 0.45mV from 25°C to +70°C, 0.2mV from +15°C to +25°C, and 0.75mV from 0°C to +15°C which, when added to the 0.2mV at +15°C, allows for 0.95mV change at 0°C.

Application Information

The Typical Operating Circuit shown on the front page shows the proper connection for the MX2700/2710. Special attention to layout is required to achieve the specified performance. A low resistance star configuration will reduce voltage errors, noise pickup, and noise coupled from the power supply.

The output voltage of the MX2700 and MX2710 can be trimmed, as shown in Figure 1, by connecting an external potentiometer between pins 12 and 14 with the wiper connected to ground. This external potentiometer provides typically ±20mV of output adjustment. The voltage drift will change by approximately 0.4ppm/°C (or 4μV/°C) per mV of adjustment.

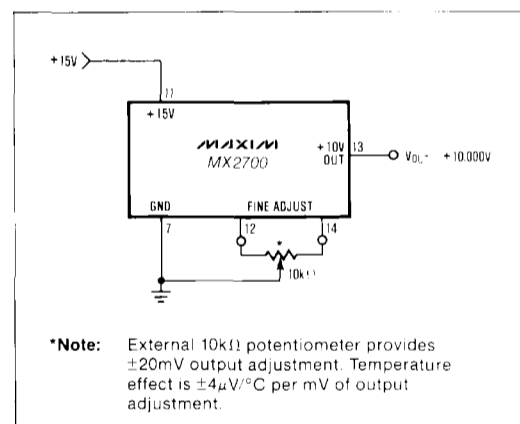

Figure 1. Fine Trim Connection, MX2700 and MX2710

MX2700/2701/2710

10 Volt Precision References

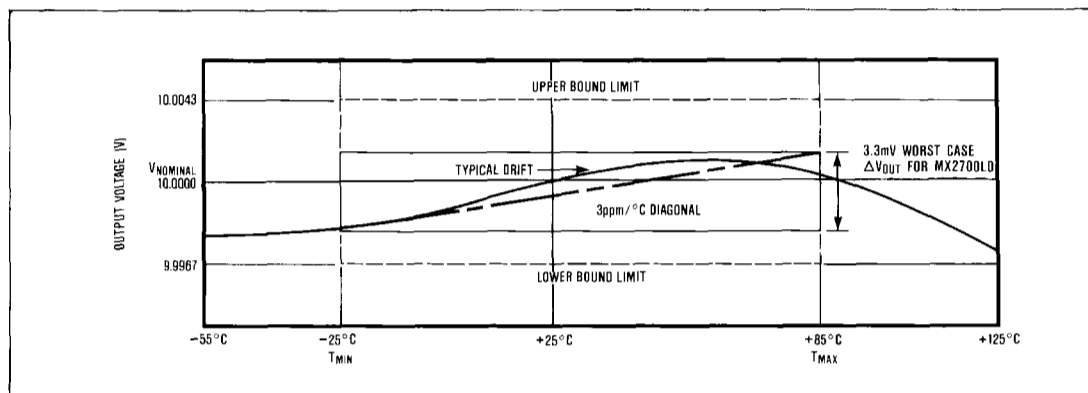

Figure 3. MX2700 Output Voltage Drift

The fine trim adjustment of the MX2701 is achieved by connecting the wiper of the potentiometer to V^- , as shown in Figure 2.

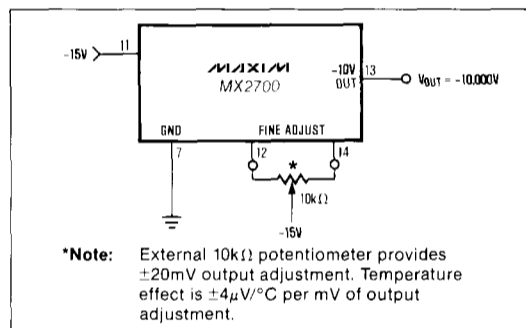

Figure 2. Fine Trim Connection, MX2701

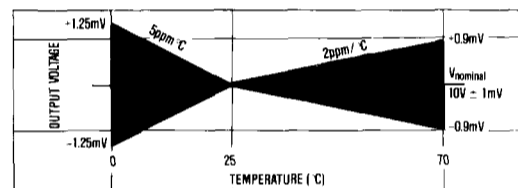

Figure 4a. MX2710K Output Voltage Drift

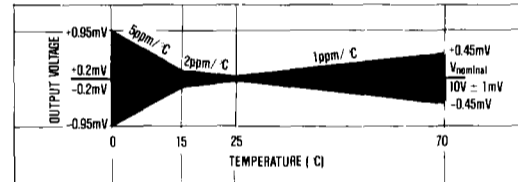

Figure 4b. MX2710L Output Voltage Drift

Maxim cannot assume responsibility for use of any circuitry other than circuitry entirely embodied in a Maxim product. No circuitry or components are implied. Maxim reserves the right to change the circuitry and specifications without notice at any time.

4 Maxim Integrated Products, 120 San Gabriel Drive, Sunnyvale, CA 94086 (415) 874-2000

© 1995 Maxim Integrated Products

Printed USA

MAXIM is a registered trademark of Maxim Inte