

TA4012F

UHF WIDE BAND AMPLIFIER APPLICATIONS

FEATURES

- Low Current : $I_{CC} = 6.5 \text{ mA}$
- Wide Band : $f = 2.0 \text{ GHz}$ (3 dB down)
- Operating Supply Voltage : $V_{CC} = 1.5 \sim 2.2 \text{ V}$

MAXIMUM RATINGS (Ta = 25°C)

CHARACTERISTIC	SYMBOL	RATING	UNIT
Supply Voltage 1	V_{CC1}	2.2	V
Supply Voltage 2 (Note 1)	V_{CC2}	3	V
Total Power Dissipation (Note 2)	P_D	300	mW
Operating Temperature	T_{opr}	-40~85	°C
Storage Temperature	T_{stg}	-55~150	°C

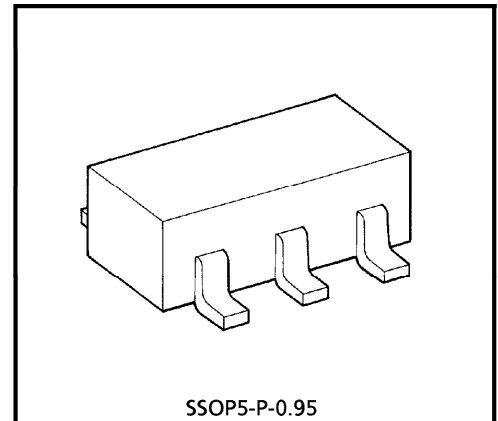

SSOP5-P-0.95
Weight : 0.014 g (Typ.)

(Note 1) : When V_{CC} is operated at less than 1/4 duty cycle.
 (Note 2) : When mounted on the glass epoxy of $2.5 \text{ cm}^2 \times 1.6 \text{ t}$

PIN ASSIGNMENT

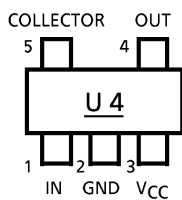

CAUTION

This device electrostatic sensitivity. Please handle with caution.

ELECTRICAL CHARACTERISTICS ($T_a = 25^\circ\text{C}$, $Z_g = Z_l = 50 \Omega$)

CHARACTERISTIC	SYMBOL	TEST CONDITION	MIN.	TYP.	MAX.	UNIT
Circuit Current	I_{CC}	$V_{CC} = 2 \text{ V}$, Non carrier	4.5	6.5	8.5	mA
Band Width	BW	$V_{CC} = 2 \text{ V}$ (Note 3)	1.8	2.0	—	GHz
Insertion Gain	$ S_{21} ^2$	$V_{CC} = 2 \text{ V}$, $f = 1.5 \text{ GHz}$	10	12	—	dB
Noise Figure	NF	$V_{CC} = 2 \text{ V}$, $f = 1.5 \text{ GHz}$	—	6	7.5	dB
Isolation	$ S_{12} ^2$	$V_{CC} = 2 \text{ V}$, $f = 1.5 \text{ GHz}$	—	-22	—	dB
Input Return Loss	$ S_{11} ^2$	$V_{CC} = 2 \text{ V}$, $f = 1.5 \text{ GHz}$	—	-6.5	—	dB
Output Return Loss	$ S_{22} ^2$	$V_{CC} = 2 \text{ V}$, $f = 1.5 \text{ GHz}$	—	-7.5	—	dB
Output Power at 1dB Gain Compression	Po1dB	$V_{CC} = 2 \text{ V}$, $f = 1.5 \text{ GHz}$	—	0	—	dBmW

(Note 3) : BW is the frequency of 3 dB down from $|S_{21}|^2$ at 1.5 GHz.

RF TEST CIRCUIT (TOP VIEW)

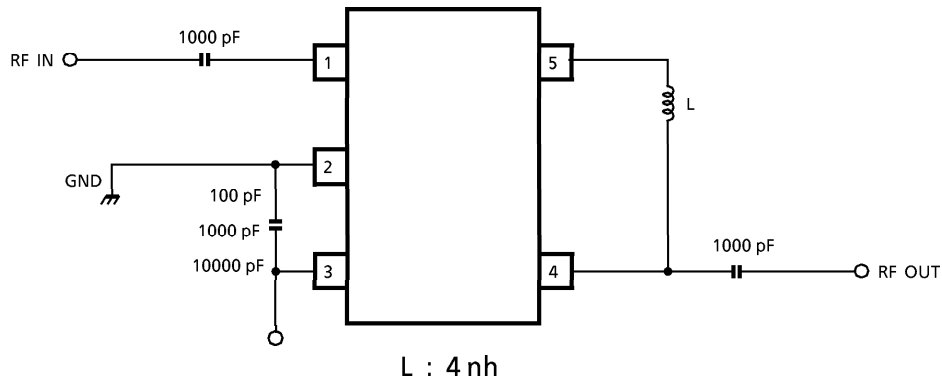

NOTICE

The circuits and measurements contained in this document are given only in the context of as examples of applications for these products. Moreover, these example application circuits are not intended for mass production, since the high-frequency characteristics (the AC characteristics) of these devices will be affected by the external components which the customer uses, by the design of the circuit and by various other conditions. It is the responsibility of the customer to design external circuits which correctly implement the intended application, and to check the characteristics of the design. TOSHIBA assume no responsibility for the integrity of customer circuit designs or applications.

EQUIVALENT CIRCUIT

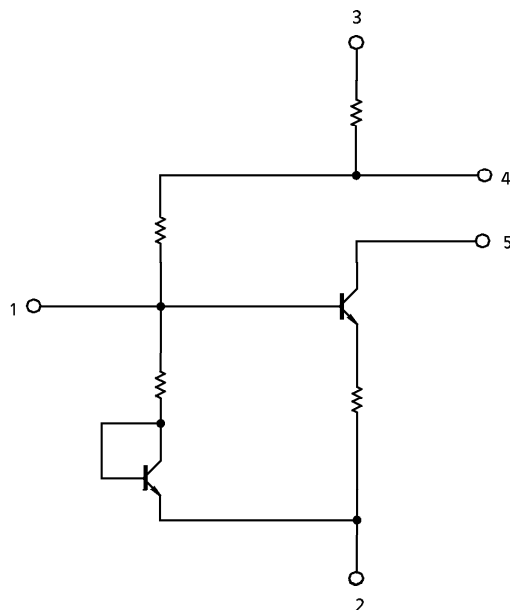

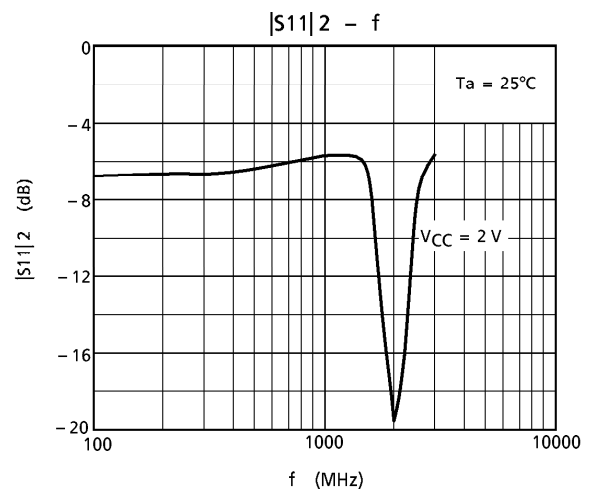
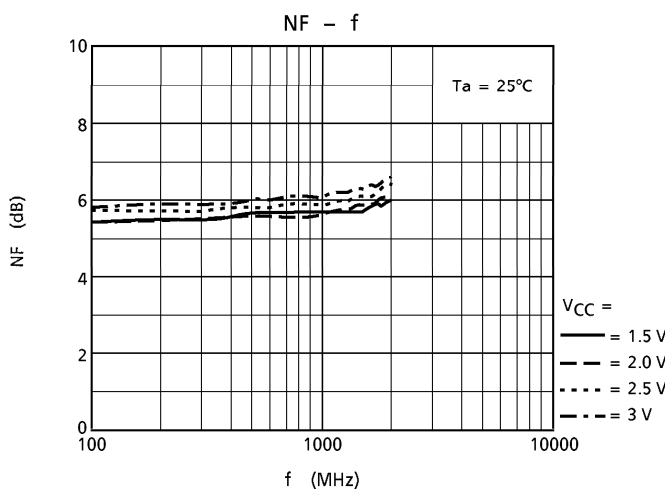
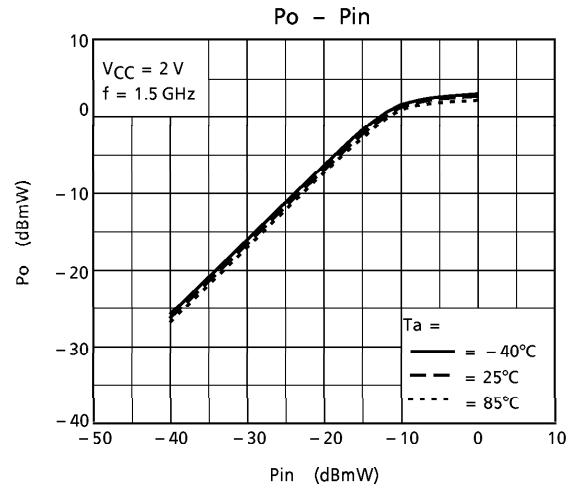
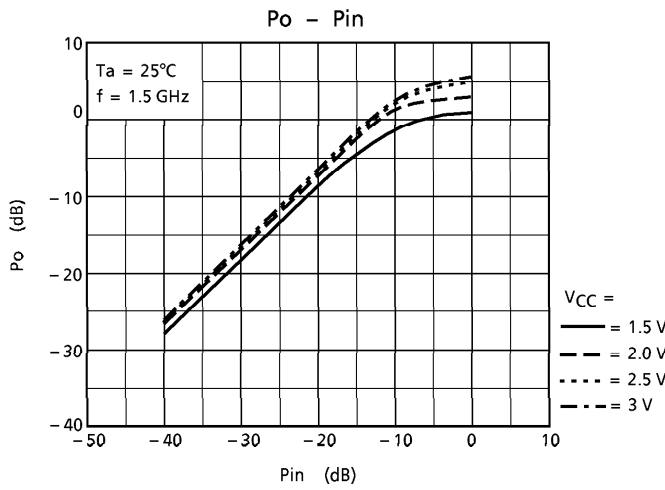
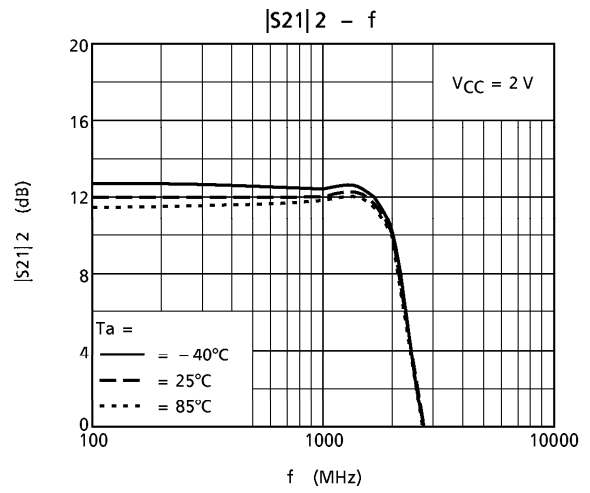
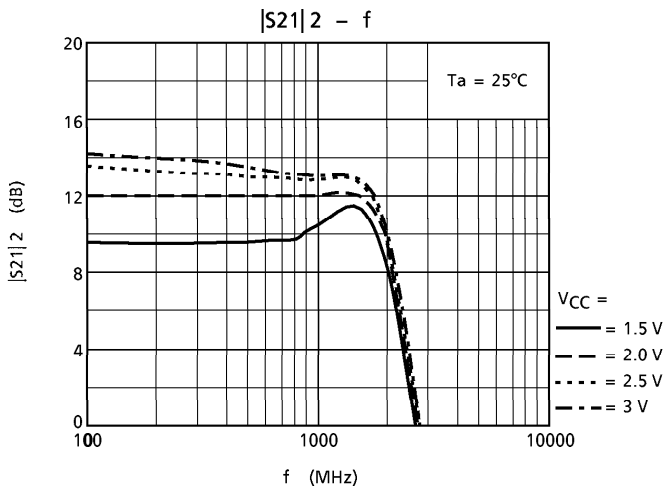

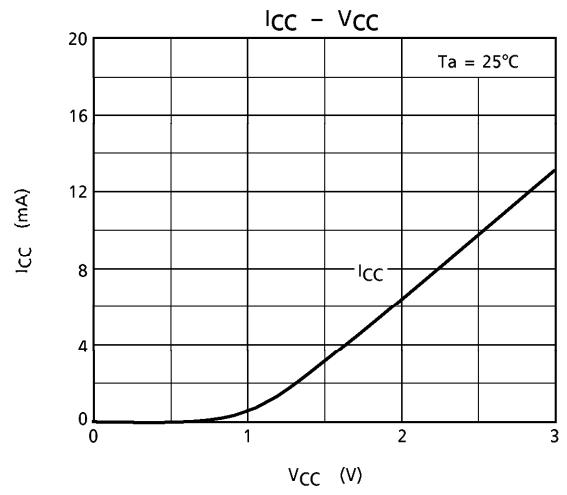
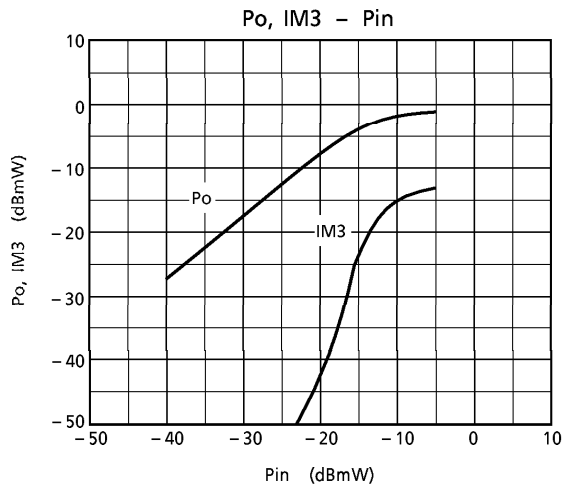
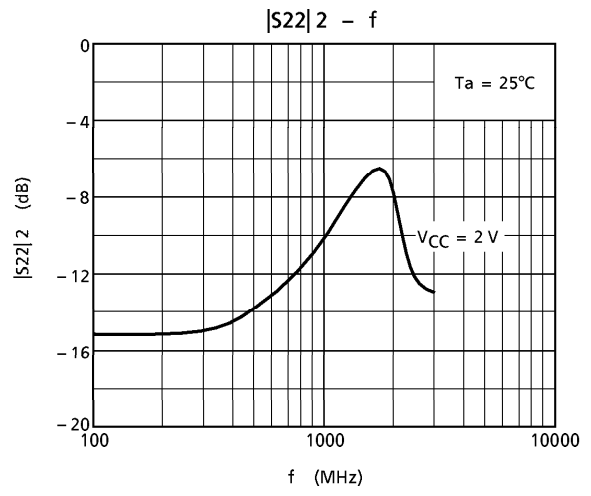
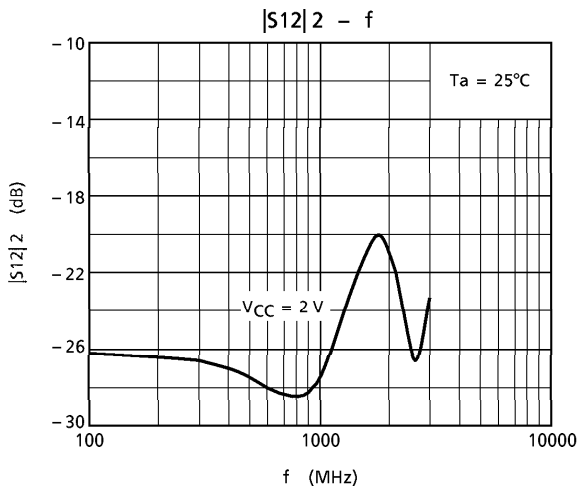

PACKAGE DIMENSIONS
SSOP5-P-0.95

Unit : mm

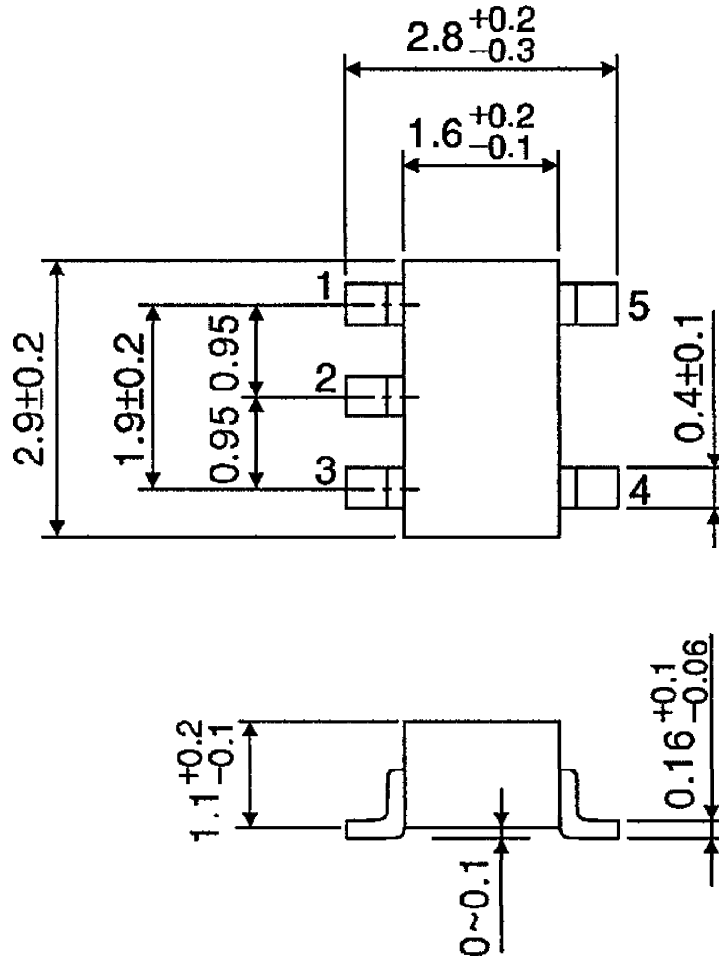

Weight : 0.014 g (Typ.)

RESTRICTIONS ON PRODUCT USE

000707EBA

- TOSHIBA is continually working to improve the quality and reliability of its products. Nevertheless, semiconductor devices in general can malfunction or fail due to their inherent electrical sensitivity and vulnerability to physical stress. It is the responsibility of the buyer, when utilizing TOSHIBA products, to comply with the standards of safety in making a safe design for the entire system, and to avoid situations in which a malfunction or failure of such TOSHIBA products could cause loss of human life, bodily injury or damage to property. In developing your designs, please ensure that TOSHIBA products are used within specified operating ranges as set forth in the most recent TOSHIBA products specifications. Also, please keep in mind the precautions and conditions set forth in the "Handling Guide for Semiconductor Devices," or "TOSHIBA Semiconductor Reliability Handbook" etc..
- The TOSHIBA products listed in this document are intended for usage in general electronics applications (computer, personal equipment, office equipment, measuring equipment, industrial robotics, domestic appliances, etc.). These TOSHIBA products are neither intended nor warranted for usage in equipment that requires extraordinarily high quality and/or reliability or a malfunction or failure of which may cause loss of human life or bodily injury ("Unintended Usage"). Unintended Usage include atomic energy control instruments, airplane or spaceship instruments, transportation instruments, traffic signal instruments, combustion control instruments, medical instruments, all types of safety devices, etc.. Unintended Usage of TOSHIBA products listed in this document shall be made at the customer's own risk.
- The products described in this document are subject to the foreign exchange and foreign trade laws.
- The information contained herein is presented only as a guide for the applications of our products. No responsibility is assumed by TOSHIBA CORPORATION for any infringements of intellectual property or other rights of the third parties which may result from its use. No license is granted by implication or otherwise under any intellectual property or other rights of TOSHIBA CORPORATION or others.
- The information contained herein is subject to change without notice.