

TOSHIBA Bipolar Linear Integrated Circuit Silicon Monolithic

## TA48S018F, TA48S02F, TA48S025F, TA48S03F, TA48S033F, TA48S05F

### 1-A Output Current and Low Dropout Voltage Regulator with ON/OFF Control Switch

The TA48S\*\*F series is the small-surface mount type low-dropout regulator of output current 1 A (maximum) with ON/OFF control switch. By control of an EN (ON/OFF) terminal, only when required, a regulator can be operated (output ON). Therefore, it is suitable for power supply circuits, such as the AV and OA, a digital equipment with the power save function, and pocket information machines and equipment of a battery drive, and these newly developed regulators contribute to energy saving of various apparatus. Moreover, output voltage has line-up from 1.8 V, and it corresponds to under-voltage operation of various apparatus.

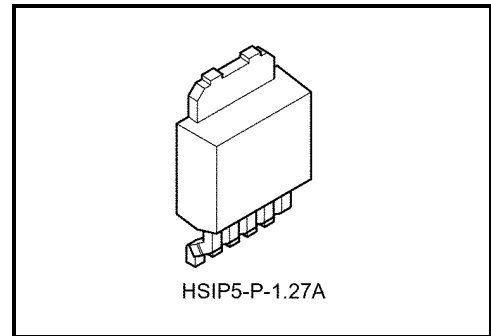

Weight: 0.29 g (typ.)

### Features

- Built-in ON/OFF control function (Active high)
- Maximum output current: 1 A
- Low output voltage: 1.8/2.0/2.5/3.0/3.3/5.0 V
- Output voltage accuracy:  $V_{OUT} \pm 3\%$  (@ $T_j = 25^\circ\text{C}$ )
- Low standby current: 800  $\mu\text{A}$  (typ.) (@ $I_{OUT} = 0\text{ A}$ )
- Low quiescent current (output OFF mode): 0.5  $\mu\text{A}$  (typ.)
- Low-dropout voltage: 0.5 V (max) (@ $I_{OUT} = 0.5\text{ A}$ )
- Protection function: Over current/Over temperature/ASO
- Package type: Surface-mount 5-pin PW-MOLD

### Pin Assignment

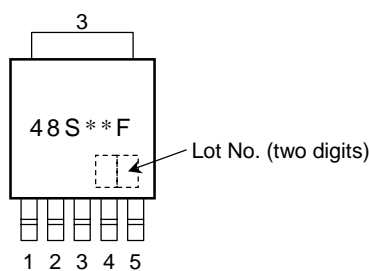

\* Lot number: Last decimal digit of the year of manufacture and January to December is denoted by letter A to L respectively.

- 1: INPUT (IN)
- 2: ENABLE (EN)
- 3: GND
- 4: NC
- 5: OUTPUT (OUT)

Note: The “\*\*” in each product name is replaced with the output voltage of each product.

**Pin Connections**

Pin No.	Symbol	Description
1	IN	Power supply input terminal. A capacitor (C <sub>IN</sub> ) is connected between GND.
2	EN	Output ON/OFF control terminal Output is ON when this pin at the "H" level, OFF when this pin open or at the "Low" level
3	GND	Ground terminal
4	NC	Non-connection
5	OUT	Output terminal. A capacitor (C <sub>OUT</sub> ) is connected between GND.

**How to Order (Note 1)**

Product No.	Package	Package Type and Capacity
TA48S**F (TE16L1)	PW-MOLD 5 Pin: Surface-mount	Tape (2000 pcs/reel)

Note 1: The "\*\*" in the each product number is replaces with the output voltage of each product.

## Block Diagram

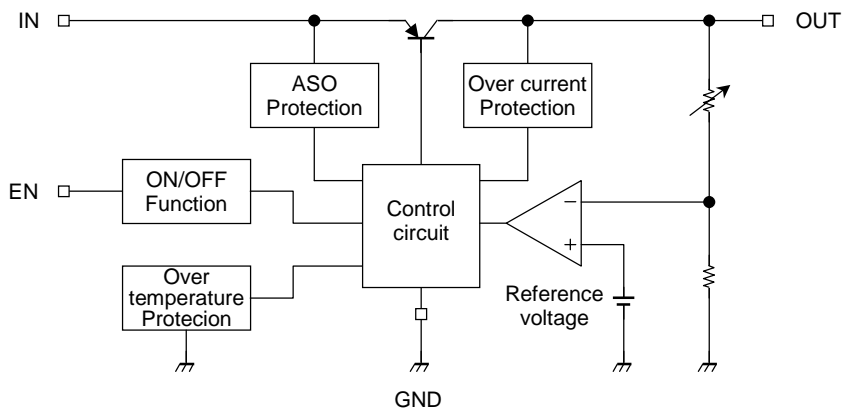

## Maximum Rating (Ta = 25°C) (Note 2)

Characteristic	Symbol	Rating	Unit
Input voltage	$V_{IN}$	16	V
EN Input voltage	$V_{EN}$	16	V
Output current	$I_{OUT}$	1	A
Operating temperature	$T_{opr}$	-40~85	°C
Junction temperature	$T_j$	150	°C
Storage temperature	$T_{stg}$	-55~150	°C
Power dissipation	Ta = 25°C	$P_D$	W
	Tc = 25°C		
Thermal resistance	junction-ambient	$R_{th(j-a)}$	°C/W
	junction-case	$R_{th(j-c)}$	

Note 2: Please don't impress current and voltage externally to the terminal if that is not specified. (include reverse polarity).

## Protection Function (Reference) (Note 3)

Characteristics	Symbol	Test Condition	Min	Typ.	Max	Unit
Over temperature	$T_{SD} (T_j)$	—	—	160	—	°C
Peak circuit current	$I_{PEAK}$	$V_{IN} = V_{OUT} + 2 V, T_j = 25°C$	—	1.5	—	A
Short circuit current	$I_{SC}$	$V_{IN} = V_{OUT} + 2 V, T_j = 25°C$	—	1.5	—	A

Note 3: Please use devices within the limits of a maximum rating when these are actually used.

## TA48S018F

### Electrical Characteristics

( $V_{EN} = 3.8\text{ V}$ ,  $C_{IN} = 0.33\ \mu\text{F}$ ,  $C_{OUT} = 10\ \mu\text{F}$ ,  $T_j = 25^\circ\text{C}$ , unless otherwise specified)

Characteristics	Symbol	Test Conditions	Min	Typ.	Max	Unit
Output voltage	$V_{OUT}$	$V_{IN} = 3.8\text{ V}$ , $I_{OUT} = 0.5\text{ A}$	1.746	1.8	1.854	V
		$2.8\text{ V} \leq V_{IN} \leq 12\text{ V}$ , $5\text{ mA} \leq I_{OUT} \leq 1\text{ A}$ , $0^\circ\text{C} \leq T_j \leq 125^\circ\text{C}$	1.72	1.8	1.88	
Line regulation	Reg·line	$2.8\text{ V} \leq V_{IN} \leq 12\text{ V}$ , $I_{OUT} = 0.5\text{ A}$	—	5	20	mV
Load regulation	Reg·load	$V_{IN} = 3.8\text{ V}$ , $5\text{ mA} \leq I_{OUT} \leq 1\text{ A}$	—	5	20	mV
Quiescent current	$I_B$	$2.8\text{ V} \leq V_{IN} \leq 12\text{ V}$ , $I_{OUT} = 0\text{ A}$	—	0.8	1.8	mA
		$2.8\text{ V} \leq V_{IN} \leq 12\text{ V}$ , $I_{OUT} = 1\text{ A}$	—	10	20	
Starting quiescent current	$I_{Bstart}$	$V_{IN} = 2.1\text{ V}$ , $I_{OUT} = 0\text{ A}$	—	0.7	5	mA
		$V_{IN} = 2.5\text{ V}$ , $I_{OUT} = 1\text{ A}$	—	10	30	
Output noise voltage	$V_{NO}$	$V_{IN} = 3.8\text{ V}$ , $I_{OUT} = 50\text{ mA}$ , $10\text{ Hz} \leq f \leq 100\text{ kHz}$	—	75	—	$\mu\text{Vrms}$
Ripple rejection	R.R.	$2.8\text{ V} \leq V_{IN} \leq 12\text{ V}$ , $I_{OUT} = 50\text{ mA}$ , $f = 120\text{ Hz}$	53	65	—	dB
Dropout voltage	$V_D$	$I_{OUT} = 0.5\text{ A}$	—	0.3	0.5	V
		$I_{OUT} = 1\text{ A}$	—	0.5	—	
Quiescent current (OFF mode)	$I_{B(OFF)}$	$V_{EN} = 0.4\text{ V}$ , $2.8\text{ V} \leq V_{IN} \leq 12\text{ V}$	—	0.5	5	$\mu\text{A}$
Output control voltage (ON)	$V_{EN(ON)}$	$I_{OUT} = 0.1\text{ A}$	2	—	—	V
Output control voltage (OFF)	$V_{EN(OFF)}$	—	—	—	0.8	V
Output control current (ON)	$I_{EN(ON)}$	$V_{IN} = V_{EN} = 3.8\text{ V}$ , $I_{OUT} = 0.1\text{ A}$	—	20	100	$\mu\text{A}$
Output control current (OFF)	$I_{EN(OFF)}$	$V_{IN} = 3.8\text{ V}$ , $V_{EN} = 0\text{ V}$	—	0.1	2	$\mu\text{A}$

## TA48S02F

### Electrical Characteristics

( $V_{EN} = 4.0\text{ V}$ ,  $C_{IN} = 0.33\ \mu\text{F}$ ,  $C_{OUT} = 10\ \mu\text{F}$ ,  $T_j = 25^\circ\text{C}$ , unless otherwise specified)

Characteristics	Symbol	Test Conditions	Min	Typ.	Max	Unit
Output voltage	$V_{OUT}$	$V_{IN} = 4.0\text{ V}$ , $I_{OUT} = 0.5\text{ A}$	1.94	2.0	2.06	V
		$3.0\text{ V} \leq V_{IN} \leq 12\text{ V}$ , $5\text{ mA} \leq I_{OUT} \leq 1\text{ A}$ , $0^\circ\text{C} \leq T_j \leq 125^\circ\text{C}$	1.91	2.0	2.09	
Line regulation	Reg·line	$3.0\text{ V} \leq V_{IN} \leq 12\text{ V}$ , $I_{OUT} = 0.5\text{ A}$	—	5	20	mV
Load regulation	Reg·load	$V_{IN} = 4.0\text{ V}$ , $5\text{ mA} \leq I_{OUT} \leq 1\text{ A}$	—	5	20	mV
Quiescent current	$I_B$	$3.0\text{ V} \leq V_{IN} \leq 12\text{ V}$ , $I_{OUT} = 0\text{ A}$	—	0.8	1.8	mA
		$3.0\text{ V} \leq V_{IN} \leq 12\text{ V}$ , $I_{OUT} = 1\text{ A}$	—	10	20	
Starting quiescent current	$I_{Bstart}$	$V_{IN} = 2.1\text{ V}$ , $I_{OUT} = 0\text{ A}$	—	0.7	5	mA
		$V_{IN} = 2.6\text{ V}$ , $I_{OUT} = 1\text{ A}$	—	10	30	
Output noise voltage	$V_{NO}$	$V_{IN} = 4.0\text{ V}$ , $I_{OUT} = 50\text{ mA}$ , $10\text{ Hz} \leq f \leq 100\text{ kHz}$	—	80	—	$\mu\text{Vrms}$
Ripple rejection	R.R.	$3.0\text{ V} \leq V_{IN} \leq 12\text{ V}$ , $I_{OUT} = 50\text{ mA}$ , $f = 120\text{ Hz}$	52	65	—	dB
Dropout voltage	$V_D$	$I_{OUT} = 0.5\text{ A}$	—	0.25	0.5	V
		$I_{OUT} = 1\text{ A}$	—	0.4	—	
Quiescent current (OFF mode)	$I_{B(OFF)}$	$V_{EN} = 0.4\text{ V}$ , $3.0\text{ V} \leq V_{IN} \leq 12\text{ V}$	—	0.5	5	$\mu\text{A}$
Output control voltage (ON)	$V_{EN(ON)}$	$I_{OUT} = 0.1\text{ A}$	2	—	—	V
Output control voltage (OFF)	$V_{EN(OFF)}$	—	—	—	0.8	V
Output control current (ON)	$I_{EN(ON)}$	$V_{IN} = V_{EN} = 4.0\text{ V}$ , $I_{OUT} = 0.1\text{ A}$	—	25	100	$\mu\text{A}$
Output control current (OFF)	$I_{EN(OFF)}$	$V_{IN} = 4.0\text{ V}$ , $V_{EN} = 0\text{ V}$	—	0.1	2	$\mu\text{A}$

## TA48S025F

### Electrical Characteristics

( $V_{EN} = 4.5\text{ V}$ ,  $C_{IN} = 0.33\ \mu\text{F}$ ,  $C_{OUT} = 10\ \mu\text{F}$ ,  $T_j = 25^\circ\text{C}$ , unless otherwise specified)

Characteristics	Symbol	Test Conditions	Min	Typ.	Max	Unit
Output voltage	$V_{OUT}$	$V_{IN} = 4.5\text{ V}$ , $I_{OUT} = 0.5\text{ A}$	2.425	2.5	2.575	V
		$3.5\text{ V} \leq V_{IN} \leq 12\text{ V}$ , $5\text{ mA} \leq I_{OUT} \leq 1\text{ A}$ , $0^\circ\text{C} \leq T_j \leq 125^\circ\text{C}$	2.388	2.5	2.612	
Line regulation	Reg·line	$3.5\text{ V} \leq V_{IN} \leq 12\text{ V}$ , $I_{OUT} = 0.5\text{ A}$	—	5	20	mV
Load regulation	Reg·load	$V_{IN} = 4.5\text{ V}$ , $5\text{ mA} \leq I_{OUT} \leq 1\text{ A}$	—	5	20	mV
Quiescent current	$I_B$	$3.5\text{ V} \leq V_{IN} \leq 12\text{ V}$ , $I_{OUT} = 0\text{ A}$	—	0.8	1.8	mA
		$3.5\text{ V} \leq V_{IN} \leq 12\text{ V}$ , $I_{OUT} = 1\text{ A}$	—	10	20	
Starting quiescent current	$I_{Bstart}$	$V_{IN} = 2.1\text{ V}$ , $I_{OUT} = 0\text{ A}$	—	0.9	5	mA
		$V_{IN} = 2.7\text{ V}$ , $I_{OUT} = 1\text{ A}$	—	12	30	
Output noise voltage	$V_{NO}$	$V_{IN} = 4.5\text{ V}$ , $I_{OUT} = 50\text{ mA}$ , $10\text{ Hz} \leq f \leq 100\text{ kHz}$	—	95	—	$\mu\text{Vrms}$
Ripple rejection	R.R.	$3.5\text{ V} \leq V_{IN} \leq 12\text{ V}$ , $I_{OUT} = 50\text{ mA}$ , $f = 120\text{ Hz}$	52	64	—	dB
Dropout voltage	$V_D$	$I_{OUT} = 0.5\text{ A}$	—	0.2	0.5	V
		$I_{OUT} = 1\text{ A}$	—	0.3	—	
Quiescent current (OFF mode)	$I_{B(OFF)}$	$V_{EN} = 0.4\text{ V}$ , $3.5\text{ V} \leq V_{IN} \leq 12\text{ V}$	—	0.5	5	$\mu\text{A}$
Output control voltage (ON)	$V_{EN(ON)}$	$I_{OUT} = 0.1\text{ A}$	2	—	—	V
Output control voltage (OFF)	$V_{EN(OFF)}$	—	—	—	0.8	V
Output control current (ON)	$I_{EN(ON)}$	$V_{IN} = V_{EN} = 4.5\text{ V}$ , $I_{OUT} = 0.1\text{ A}$	—	30	100	$\mu\text{A}$
Output control current (OFF)	$I_{EN(OFF)}$	$V_{IN} = 4.5\text{ V}$ , $V_{EN} = 0\text{ V}$	—	0.1	2	$\mu\text{A}$

## TA48S03F

### Electrical Characteristics

( $V_{EN} = 5.0\text{ V}$ ,  $C_{IN} = 0.33\ \mu\text{F}$ ,  $C_{OUT} = 10\ \mu\text{F}$ ,  $T_j = 25^\circ\text{C}$ , unless otherwise specified)

Characteristics	Symbol	Test Conditions	Min	Typ.	Max	Unit
Output voltage	$V_{OUT}$	$V_{IN} = 5.0\text{ V}$ , $I_{OUT} = 0.5\text{ A}$	2.91	3.0	3.09	V
		$4.0\text{ V} \leq V_{IN} \leq 12\text{ V}$ , $5\text{ mA} \leq I_{OUT} \leq 1\text{ A}$ , $0^\circ\text{C} \leq T_j \leq 125^\circ\text{C}$	2.865	3.0	3.135	
Line regulation	Reg·line	$4.0\text{ V} \leq V_{IN} \leq 12\text{ V}$ , $I_{OUT} = 0.5\text{ A}$	—	5	20	mV
Load regulation	Reg·load	$V_{IN} = 5.0\text{ V}$ , $5\text{ mA} \leq I_{OUT} \leq 1\text{ A}$	—	5	20	mV
Quiescent current	$I_B$	$4.0\text{ V} \leq V_{IN} \leq 12\text{ V}$ , $I_{OUT} = 0\text{ A}$	—	0.8	1.8	mA
		$4.0\text{ V} \leq V_{IN} \leq 12\text{ V}$ , $I_{OUT} = 1\text{ A}$	—	10	20	
Starting quiescent current	$I_{Bstart}$	$V_{IN} = 2.1\text{ V}$ , $I_{OUT} = 0\text{ A}$	—	1.1	5	mA
		$V_{IN} = 2.8\text{ V}$ , $I_{OUT} = 1\text{ A}$	—	13	30	
Output noise voltage	$V_{NO}$	$V_{IN} = 5.0\text{ V}$ , $I_{OUT} = 50\text{ mA}$ , $10\text{ Hz} \leq f \leq 100\text{ kHz}$	—	110	—	$\mu\text{Vrms}$
Ripple rejection	R.R.	$4.0\text{ V} \leq V_{IN} \leq 12\text{ V}$ , $I_{OUT} = 50\text{ mA}$ , $f = 120\text{ Hz}$	50	63	—	dB
Dropout voltage	$V_D$	$I_{OUT} = 0.5\text{ A}$	—	0.2	0.5	V
		$I_{OUT} = 1\text{ A}$	—	0.3	—	
Quiescent current (OFF mode)	$I_{B(OFF)}$	$V_{EN} = 0.4\text{ V}$ , $4.0\text{ V} \leq V_{IN} \leq 12\text{ V}$	—	0.5	5	$\mu\text{A}$
Output control voltage (ON)	$V_{EN(ON)}$	$I_{OUT} = 0.1\text{ A}$	2	—	—	V
Output control voltage (OFF)	$V_{EN(OFF)}$	—	—	—	0.8	V
Output control current (ON)	$I_{EN(ON)}$	$V_{IN} = V_{EN} = 5.0\text{ V}$ , $I_{OUT} = 0.1\text{ A}$	—	35	100	$\mu\text{A}$
Output control current (OFF)	$I_{EN(OFF)}$	$V_{IN} = 5.0\text{ V}$ , $V_{EN} = 0\text{ V}$	—	0.1	2	$\mu\text{A}$

## TA48S033F

### Electrical Characteristics

( $V_{EN} = 5.3 \text{ V}$ ,  $C_{IN} = 0.33 \mu\text{F}$ ,  $C_{OUT} = 10 \mu\text{F}$ ,  $T_j = 25^\circ\text{C}$ , unless otherwise specified)

Characteristics	Symbol	Test Conditions	Min	Typ.	Max	Unit
Output voltage	$V_{OUT}$	$V_{IN} = 5.3 \text{ V}$ , $I_{OUT} = 0.5 \text{ A}$	3.2	3.3	3.4	V
		$4.3 \text{ V} \leq V_{IN} \leq 12 \text{ V}$ , $5 \text{ mA} \leq I_{OUT} \leq 1 \text{ A}$ , $0^\circ\text{C} \leq T_j \leq 125^\circ\text{C}$	3.152	3.3	3.448	
Line regulation	Reg·line	$4.3 \text{ V} \leq V_{IN} \leq 12 \text{ V}$ , $I_{OUT} = 0.5 \text{ A}$	—	5	20	mV
Load regulation	Reg·load	$V_{IN} = 5.3 \text{ V}$ , $5 \text{ mA} \leq I_{OUT} \leq 1 \text{ A}$	—	5	20	mV
Quiescent current	$I_B$	$4.3 \text{ V} \leq V_{IN} \leq 12 \text{ V}$ , $I_{OUT} = 0 \text{ A}$	—	0.8	1.8	mA
		$4.3 \text{ V} \leq V_{IN} \leq 12 \text{ V}$ , $I_{OUT} = 1 \text{ A}$	—	10	20	
Starting quiescent current	$I_{Bstart}$	$V_{IN} = 2.1 \text{ V}$ , $I_{OUT} = 0 \text{ A}$	—	1.1	5	mA
		$V_{IN} = 2.9 \text{ V}$ , $I_{OUT} = 1 \text{ A}$	—	13	30	
Output noise voltage	$V_{NO}$	$V_{IN} = 5.3 \text{ V}$ , $I_{OUT} = 50 \text{ mA}$ , $10 \text{ Hz} \leq f \leq 100 \text{ kHz}$	—	115	—	$\mu\text{Vrms}$
Ripple rejection	R.R.	$4.3 \text{ V} \leq V_{IN} \leq 12 \text{ V}$ , $I_{OUT} = 50 \text{ mA}$ , $f = 120 \text{ Hz}$	48	61	—	dB
Dropout voltage	$V_D$	$I_{OUT} = 0.5 \text{ A}$	—	0.2	0.5	V
		$I_{OUT} = 1 \text{ A}$	—	0.3	—	
Quiescent current (OFF mode)	$I_{B(OFF)}$	$V_{EN} = 0.4 \text{ V}$ , $4.3 \text{ V} \leq V_{IN} \leq 12 \text{ V}$	—	0.5	5	$\mu\text{A}$
Output control voltage (ON)	$V_{EN(ON)}$	$I_{OUT} = 0.1 \text{ A}$	2	—	—	V
Output control voltage (OFF)	$V_{EN(OFF)}$	—	—	—	0.8	V
Output control current (ON)	$I_{EN(ON)}$	$V_{IN} = V_{EN} = 5.3 \text{ V}$ , $I_{OUT} = 0.1 \text{ A}$	—	35	100	$\mu\text{A}$
Output control current (OFF)	$I_{EN(OFF)}$	$V_{IN} = 5.3 \text{ V}$ , $V_{EN} = 0 \text{ V}$	—	0.1	2	$\mu\text{A}$

## TA48S05F

### Electrical Characteristics

( $V_{EN} = 7.0 \text{ V}$ ,  $C_{IN} = 0.33 \mu\text{F}$ ,  $C_{OUT} = 10 \mu\text{F}$ ,  $T_j = 25^\circ\text{C}$ , unless otherwise specified)

Characteristics	Symbol	Test Conditions	Min	Typ.	Max	Unit
Output voltage	$V_{OUT}$	$V_{IN} = 7 \text{ V}$ , $I_{OUT} = 0.5 \text{ A}$	4.85	5.0	5.15	V
		$6.0 \text{ V} \leq V_{IN} \leq 12 \text{ V}$ , $5 \text{ mA} \leq I_{OUT} \leq 1 \text{ A}$ , $0^\circ\text{C} \leq T_j \leq 125^\circ\text{C}$	4.775	5.0	5.225	
Line regulation	Reg·line	$6.0 \text{ V} \leq V_{IN} \leq 12 \text{ V}$ , $I_{OUT} = 0.5 \text{ A}$	—	5	20	mV
Load regulation	Reg·load	$V_{IN} = 7.0 \text{ V}$ , $5 \text{ mA} \leq I_{OUT} \leq 1 \text{ A}$	—	5	30	mV
Quiescent current	$I_B$	$6.0 \text{ V} \leq V_{IN} \leq 12 \text{ V}$ , $I_{OUT} = 0 \text{ A}$	—	0.8	1.8	mA
		$6.0 \text{ V} \leq V_{IN} \leq 12 \text{ V}$ , $I_{OUT} = 1 \text{ A}$	—	10	20	
Starting quiescent current	$I_{Bstart}$	$V_{IN} = 2.1 \text{ V}$ , $I_{OUT} = 0 \text{ A}$	—	1.3	5	mA
		$V_{IN} = 3.0 \text{ V}$ , $I_{OUT} = 1 \text{ A}$	—	14	30	
Output noise voltage	$V_{NO}$	$V_{IN} = 7.0 \text{ V}$ , $I_{OUT} = 50 \text{ mA}$ , $10 \text{ Hz} \leq f \leq 100 \text{ kHz}$	—	150	—	$\mu\text{Vrms}$
Ripple rejection	R.R.	$6.0 \text{ V} \leq V_{IN} \leq 12 \text{ V}$ , $I_{OUT} = 50 \text{ mA}$ , $f = 120 \text{ Hz}$	48	60	—	dB
Dropout voltage	$V_D$	$I_{OUT} = 0.5 \text{ A}$	—	0.2	0.5	V
		$I_{OUT} = 1 \text{ A}$	—	0.3	—	
Quiescent current (OFF mode)	$I_{B(OFF)}$	$V_{EN} = 0.4 \text{ V}$ , $6.0 \text{ V} \leq V_{IN} \leq 12 \text{ V}$	—	0.5	5	$\mu\text{A}$
Output control voltage (ON)	$V_{EN(ON)}$	$I_{OUT} = 0.1 \text{ A}$	2	—	—	V
Output control voltage (OFF)	$V_{EN(OFF)}$	—	—	—	0.8	V
Output control current (ON)	$I_{EN(ON)}$	$V_{IN} = V_{EN} = 7.0 \text{ V}$ , $I_{OUT} = 0.1 \text{ A}$	—	50	100	$\mu\text{A}$
Output control current (OFF)	$I_{EN(OFF)}$	$V_{IN} = 7.0 \text{ V}$ , $V_{EN} = 0 \text{ V}$	—	0.1	2	$\mu\text{A}$

## Precaution on Application

In  $T_j = 25^\circ\text{C}$  within each item measurement condition, it is regulation in the state where a pulse examination is carried out and the drift of the property value by junction-temperature rise of a tip can be disregarded.

When a input voltage is impressed steeply, since output voltage may go up momentarily, a enable terminal voltage should be careful according to load conditions etc. also in the state of "Low".

## Standard Application Circuit

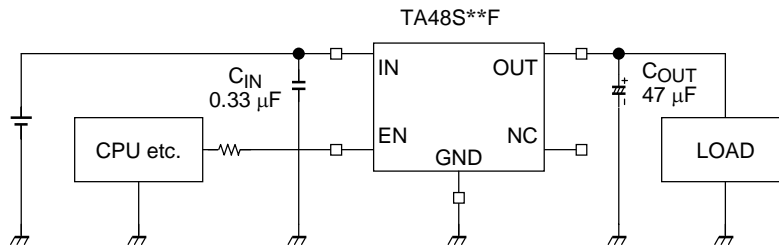

Connect the input terminal and GND, and the output terminal and GND, by capacitor respectively.

The capacitances should be determined experimentally. In particular, adequate investigation should be made so that there is no problem even at time of high or low temperature.

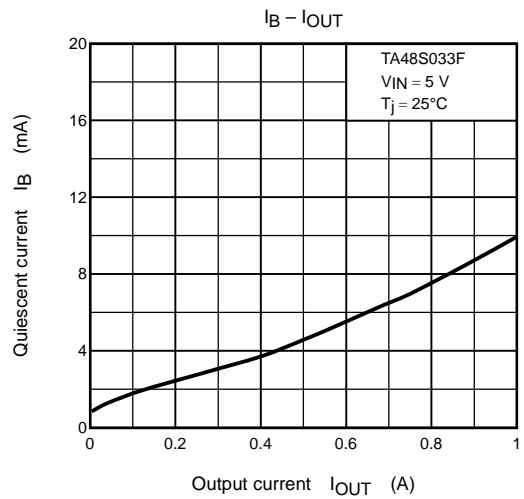
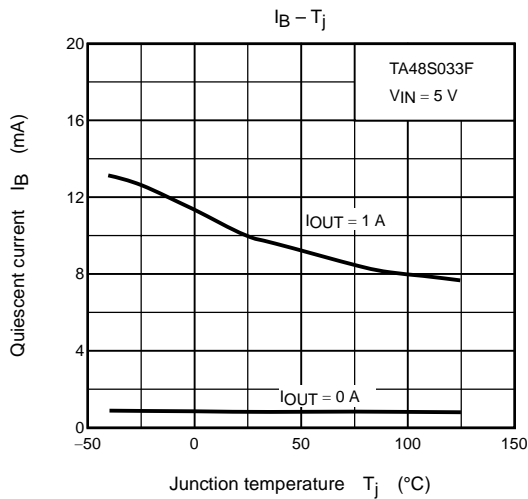
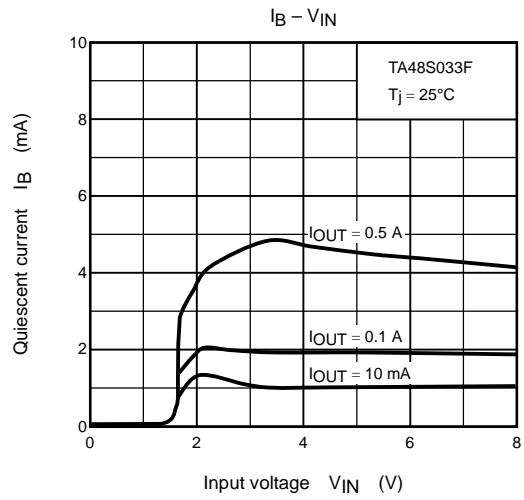
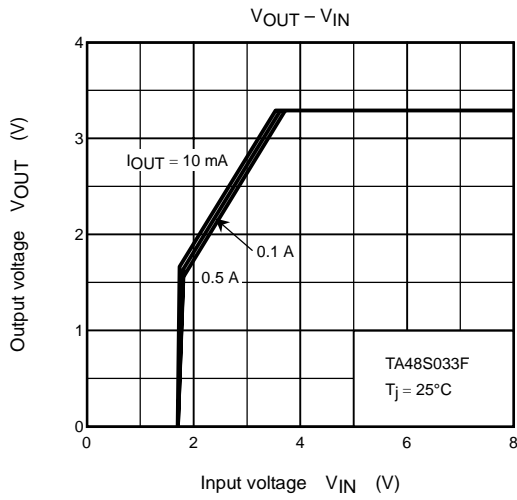
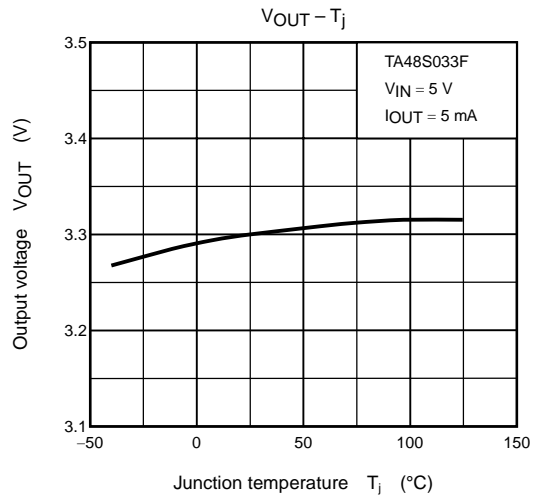
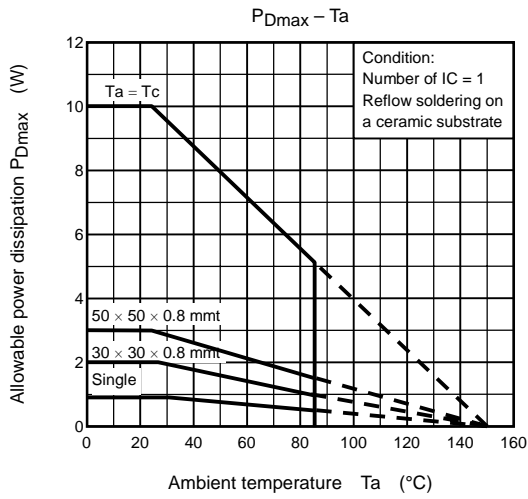



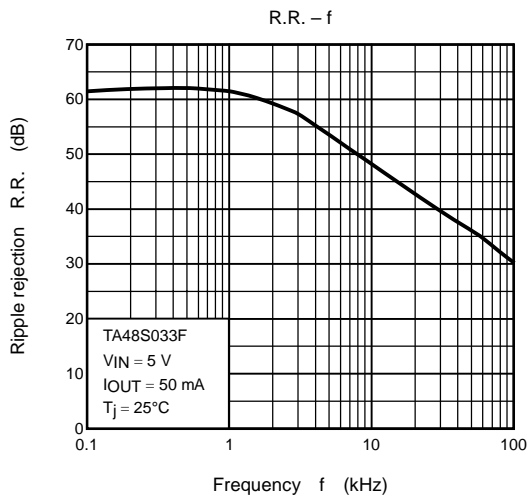
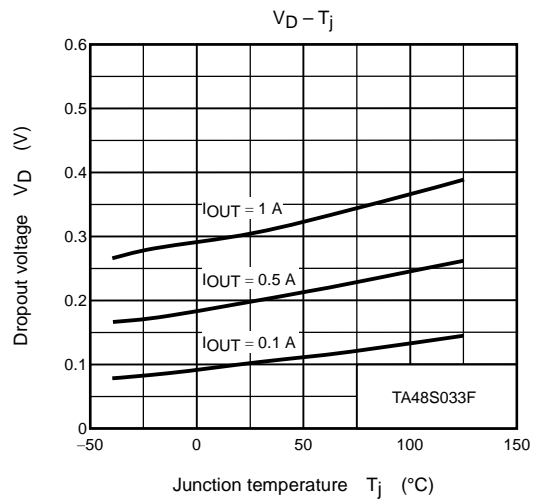
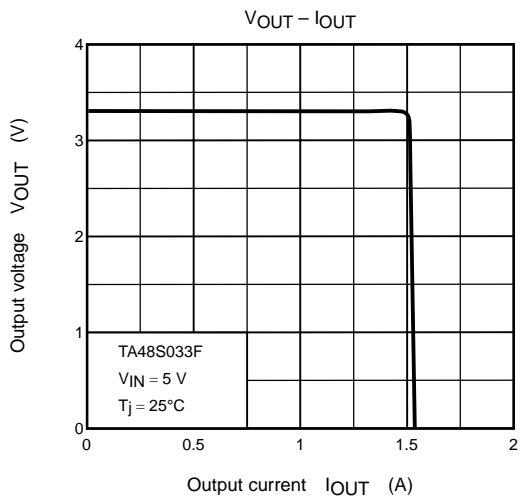

**Package Dimensions**

HSIP5-P-1.27A

Unit: mm

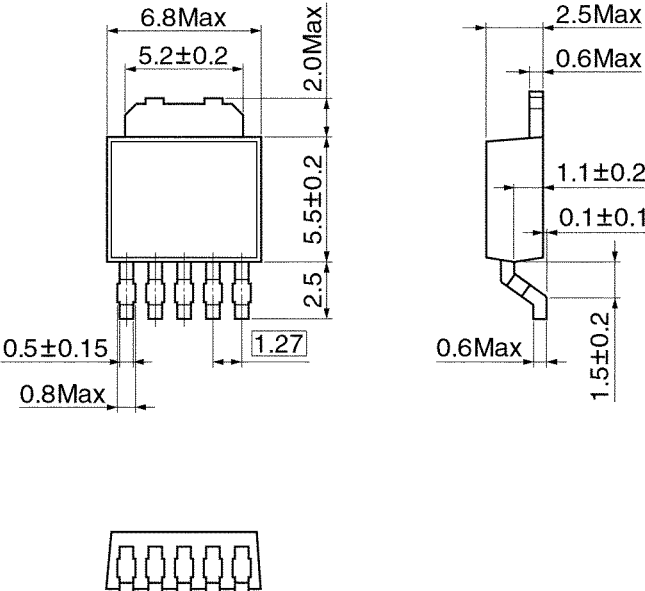

Weight: 0.29 g (typ.)

**RESTRICTIONS ON PRODUCT USE**

000707EBA

- TOSHIBA is continually working to improve the quality and reliability of its products. Nevertheless, semiconductor devices in general can malfunction or fail due to their inherent electrical sensitivity and vulnerability to physical stress. It is the responsibility of the buyer, when utilizing TOSHIBA products, to comply with the standards of safety in making a safe design for the entire system, and to avoid situations in which a malfunction or failure of such TOSHIBA products could cause loss of human life, bodily injury or damage to property.  
In developing your designs, please ensure that TOSHIBA products are used within specified operating ranges as set forth in the most recent TOSHIBA products specifications. Also, please keep in mind the precautions and conditions set forth in the "Handling Guide for Semiconductor Devices," or "TOSHIBA Semiconductor Reliability Handbook" etc.
- The TOSHIBA products listed in this document are intended for usage in general electronics applications (computer, personal equipment, office equipment, measuring equipment, industrial robotics, domestic appliances, etc.). These TOSHIBA products are neither intended nor warranted for usage in equipment that requires extraordinarily high quality and/or reliability or a malfunction or failure of which may cause loss of human life or bodily injury ("Unintended Usage"). Unintended Usage include atomic energy control instruments, airplane or spaceship instruments, transportation instruments, traffic signal instruments, combustion control instruments, medical instruments, all types of safety devices, etc.. Unintended Usage of TOSHIBA products listed in this document shall be made at the customer's own risk.
- The products described in this document are subject to the foreign exchange and foreign trade laws.
- The information contained herein is presented only as a guide for the applications of our products. No responsibility is assumed by TOSHIBA CORPORATION for any infringements of intellectual property or other rights of the third parties which may result from its use. No license is granted by implication or otherwise under any intellectual property or other rights of TOSHIBA CORPORATION or others.
- The information contained herein is subject to change without notice.