

TOSHIBA BIPOLAR LINEAR INTEGRATED CIRCUIT SILICON MONOLITHIC

TA75S01F

SINGLE OPERATIONAL AMPLIFIER

FEATURES

- In the linear mode the input common mode voltage range includes ground.
- The internally compensated Operational Amplifier is small package.
- Low power dissipation and power drain suitable for battery operation.
- Differential input voltage range equal to the power supply voltage.
- Large output voltage swing : $0V_{DC}$ to $3.4V_{DC}$ ($V_{DC} = 5V_{DC}$)
- Wide power supply voltage range and single power supply is possible.
- Single supply $3V_{DC}$ to $12V_{DC}$ or dual supplies $\pm 1.5V_{DC}$ to $\pm 6V_{DC}$.

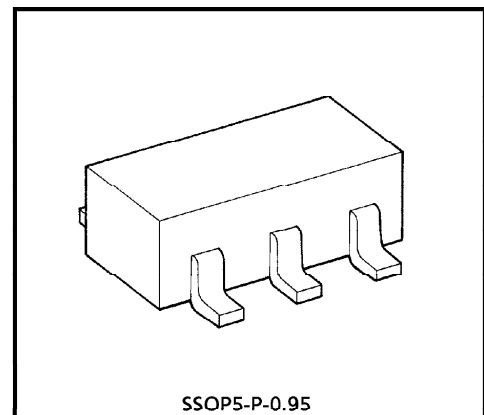

Weight : 0.014g (Typ.)

MARKING (TOP VIEW)

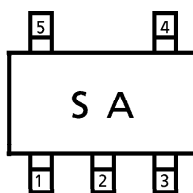

PIN CONNECTION (TOP VIEW)

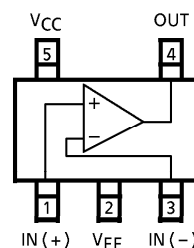

961001EBA2

● TOSHIBA is continually working to improve the quality and the reliability of its products. Nevertheless, semiconductor devices in general can malfunction or fail due to their inherent electrical sensitivity and vulnerability to physical stress. It is the responsibility of the buyer, when utilizing TOSHIBA products, to observe standards of safety, and to avoid situations in which a malfunction or failure of a TOSHIBA product could cause loss of human life, bodily injury or damage to property. In developing your designs, please ensure that TOSHIBA products are used within specified operating ranges as set forth in the most recent products specifications. Also, please keep in mind the precautions and conditions set forth in the TOSHIBA Semiconductor Reliability Handbook.

● The products described in this document are subject to foreign exchange and foreign trade control laws.

● The information contained herein is presented only as a guide for the applications of our products. No responsibility is assumed by TOSHIBA CORPORATION for any infringements of intellectual property or other rights of the third parties which may result from its use. No license is granted by implication or otherwise under any intellectual property or other rights of TOSHIBA CORPORATION or others.

● The information contained herein is subject to change without notice.

EQUIVALENT CIRCUIT

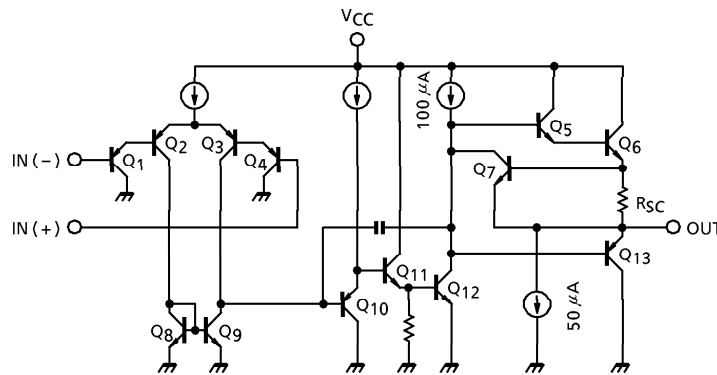

MAXIMUM RATINGS (Ta = 25°C)

CHARACTERISTIC	SYMBOL	RATING	UNIT
Supply Voltage	V _{CC} , V _{EE}	± 6 or 12	V
Differential Input Voltage	DV _{IN}	± 12	V
Input Voltage	V _{IN}	- 0.3~V _{CC}	V
Power Dissipation	P _D	200	mW
Operating Temperature	T _{opr}	- 40~85	°C
Storage Temperature	T _{stg}	- 55~125	°C

ELECTRICAL CHARACTERISTICS (V_{CC} = 5V, V_{EE} = GND, Ta = 25°C)

CHARACTERISTIC	SYMBOL	TEST CIR-CUIT	TEST CONDITION	MIN.	TYP.	MAX.	UNIT
Input Offset Voltage	V _{IO}	1	R _g ≤ 10kΩ	—	2	7	mV
Input Offset Current	I _{IO}	2	—	—	5	50	nA
Input Bias Current	I _I	2	—	—	45	250	nA
Common Mode Input Voltage	CMV _{IN}	3	—	0	—	V _{CC} - 1.5	V
Supply Current	I _{CC}	4	—	—	0.4	0.8	mA
Voltage Gain	G _V	—	R _L ≥ 2kΩ	86	100	—	dB
Maximum Output Voltage Swing	V _{op-p}	5	R _L = 2kΩ	0	—	3.4	V
Common Mode Rejection Ratio	CMRR	3	—	65	85	—	dB
Supply Voltage Rejection Ratio	SVRR	—	R _g = 10kΩ	65	100	—	dB
Source Current	I _{source}	6	IN (-) = 0V, IN (+) = 1V	20	40	—	mA
Sink Current	I _{sink}	7	IN (-) = 1V, IN (+) = 0V	10	20	—	mA
Unity Gain Cross Frequency	f _T	—	—	—	0.3	—	MHz

TEST CIRCUIT

(1) V_{IO}

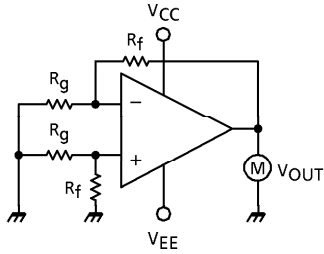

(2) I_I, I_{IO}

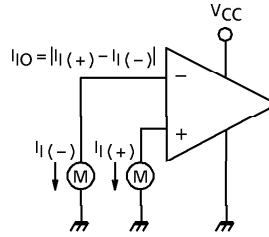

(3) $CMV_{IN}, CMRR$

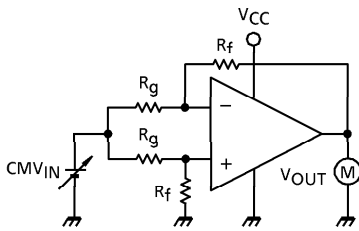

(4) I_{CC}

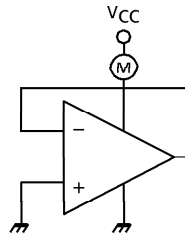

(5) V_{op-p}

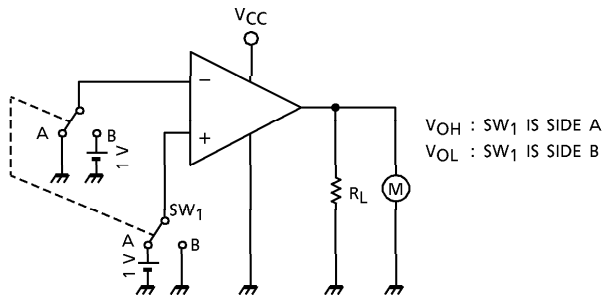

(6) I_{source}

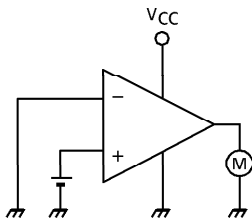

(7) I_{sink}

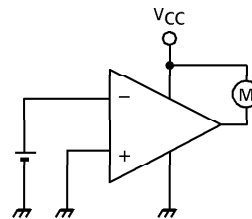

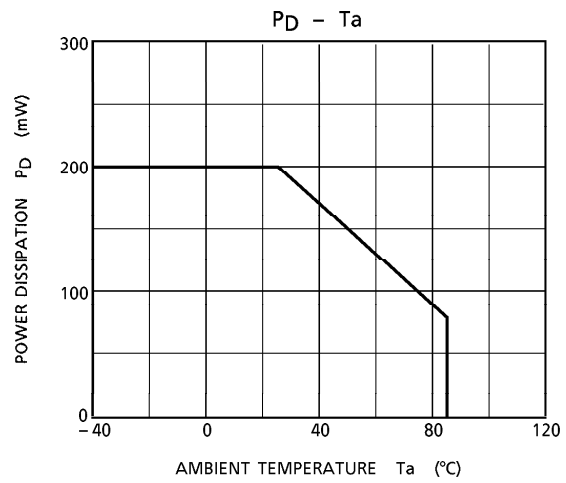
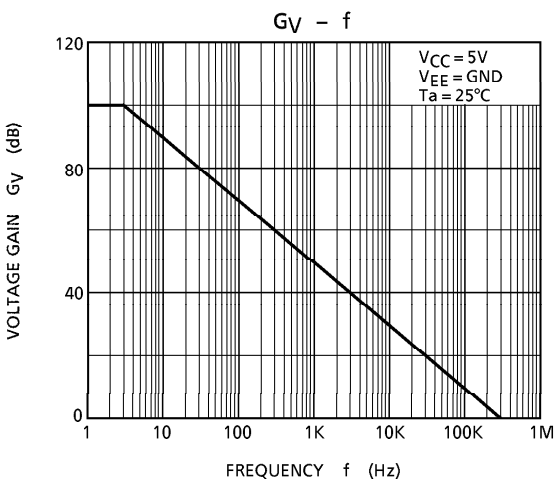
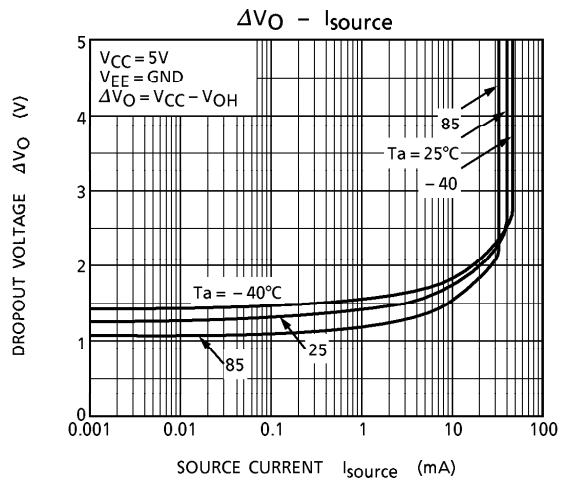
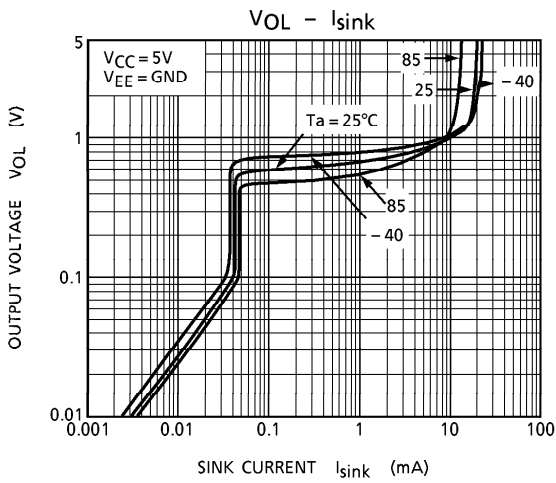
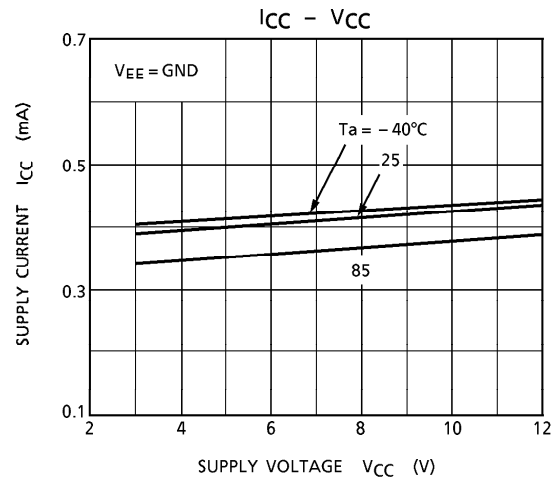
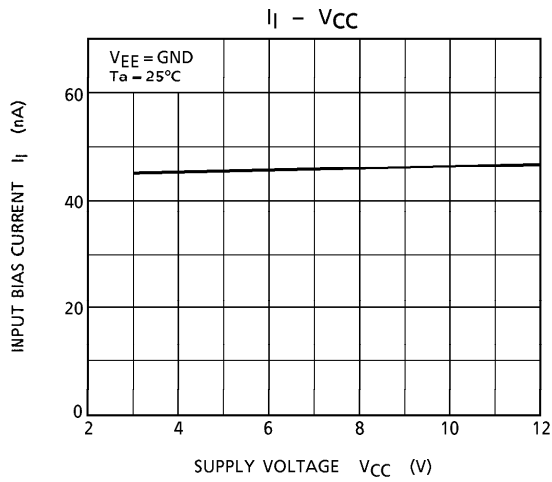

OUTLINE DRAWING
SSOP5-P-0.95

Unit : mm

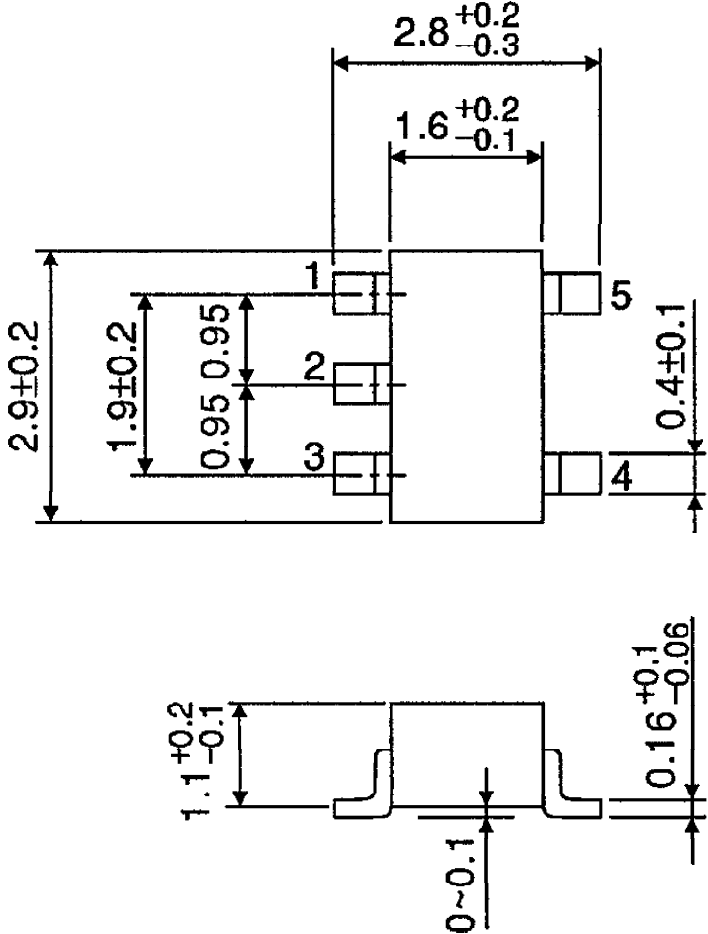

Weight : 0.014g (Typ.)