

TA76431S

Adjustable Precision Shunt Regulator

Features

- Precision reference voltage: $V_{REF} = 2.495\text{ V} \pm 2\%$
- Small temperature coefficient: $|\alpha V_{REF}| = 46\text{ ppm}/^\circ\text{C}$
- Adjustable output voltage: $V_{REF} \leq V_{OUT} \leq 36\text{ V}$
- Low dynamic output impedance: $|Z_{KA}| = 0.15\ \Omega$ (Typ.)

Pin Assignment

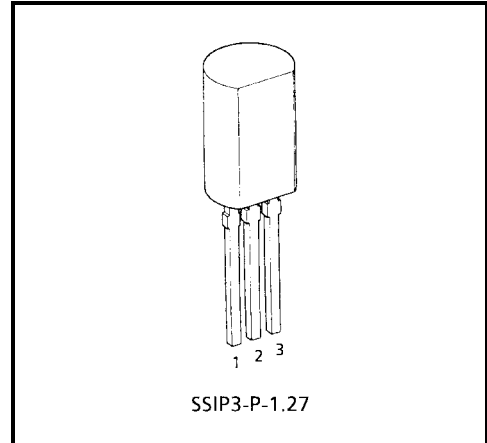
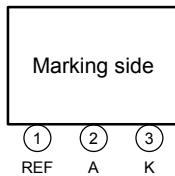

Weight: 0.36 g (Typ.)

Functional Block Diagram

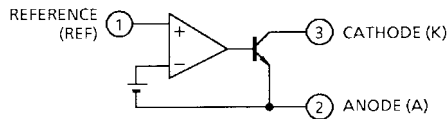

Circuit Symbol

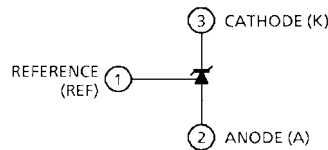

This IC contains electrostatic sensitive element.
Please handle with caution.

Equivalent Circuit

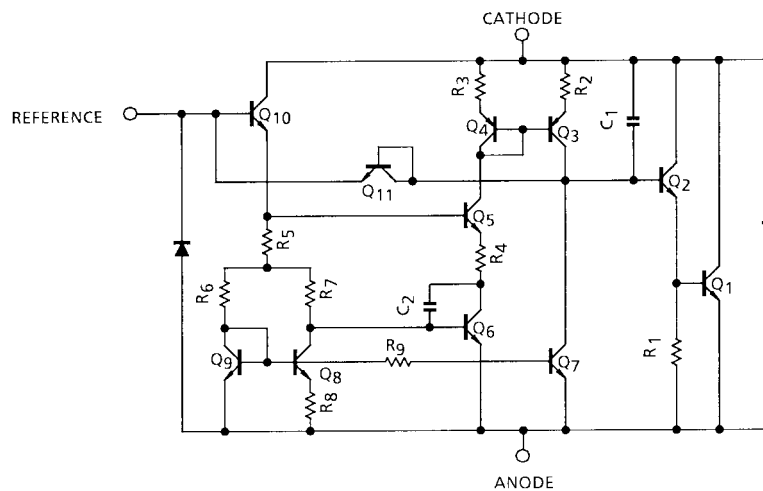

Maximum Ratings (Ta = 25°C)

Characteristics	Symbol	Rating	Unit
Cathode voltage	V _{KA}	37	V
Cathode current	I _K	-100~150	mA
Reference voltage	V _{REF}	7	V
Reference current	I _{REF}	50	μA
Reference-anode reverse current	-I _{REF}	10	mA
Power dissipation	Ta = 25°C P _D	800	mW
Operating temperature	T _{opr}	-40~85	°C
Storage temperature	T _{stg}	-55~150	°C

Recommended Operating Conditions

Characteristics	Symbol	Min	Typ.	Max	Unit
Cathode voltage	V _{KA}	V _{REF}	—	36	V
Cathode current	I _K	1	—	100	mA
Operating temperature	T _{opr}	-40	—	85	°C

Electrical Characteristics (Unless otherwise specified, Ta = 25°C, I_K = 10 mA)

Characteristics	Symbol	Test Circuit	Test Condition	Min	Typ.	Max	Unit
Reference voltage	V _{REF}	—	V _{KA} = V _{REF}	2.440	2.495	2.550	V
Deviation of reference input voltage over temperature	V _{REF (dev)} (Note 1)	—	0°C ≤ Ta ≤ 70°C, V _{KA} = V _{REF}	—	8	17	mV
Ratio of change in reference input voltage to the change in cathode voltage	ΔV _{REF} /ΔV	—	V _{REF} ≤ V _{KA} ≤ 10 V	—	0.8	2.7	mV/V
		—	10 V ≤ V _{KA} ≤ 36 V	—	0.5	2.0	
Reference input current	I _{REF}	—	V _{KA} = V _{REF}	—	1.4	4	μA
Deviation of reference input current over temperature	I _{REF (dev)} (Note 1)	—	0°C ≤ Ta ≤ 70°C, V _{KA} = V _{REF} R ₁ = 10 kΩ, R ₂ = ∞	—	0.3	1.2	μA
Minimum cathode current for regulation	I _{Kmin}	—	V _{KA} = V _{REF}	—	0.4	1.0	mA
Off-state cathode current	I _{Koff}	—	V _{KA} = 36 V, V _{REF} = 0 V	—	—	1.0	μA
Dynamic impedance	Z _{KA}	—	V _{KA} = V _{REF} , f ≤ 1 kHz 1 mA ≤ I _K ≤ 100 mA	—	0.15	0.5	Ω

Note 1: The deviation parameters V_{REF (dev)} and I_{REF (dev)} are defined as the maximum variation of the V_{REF} and I_{REF} over the rated temperature range.

The average temperature coefficient of the V_{REF} is defined as;

$$|\alpha V_{REF}| = \frac{V_{REF (dev)}}{V_{REF@25^\circ C}} \times 10^6 \text{ (ppm / } ^\circ\text{C)}$$

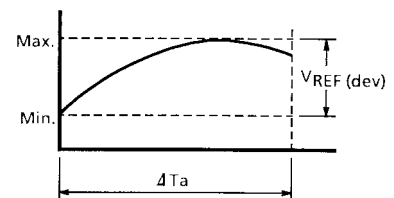

Test Parameter

(1) $V_{KA} = V_{REF}$ mode

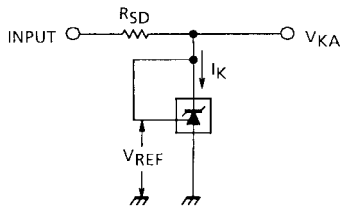

(2) $V_{KA} > V_{REF}$ mode

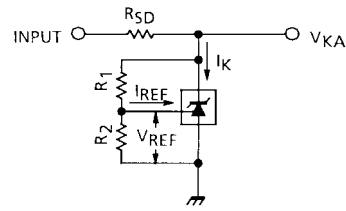

$$V_{KA} = V_{REF} \left(1 + \frac{R_1}{R_2} \right) + I_{REF} \cdot R_1$$

(3) Off-state mode

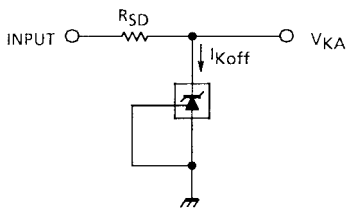

Typical Applications

(1) 2.5 V reference

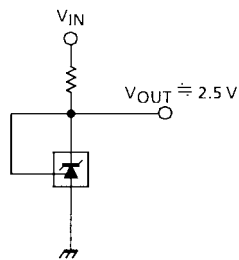

(2) Shunt regulator

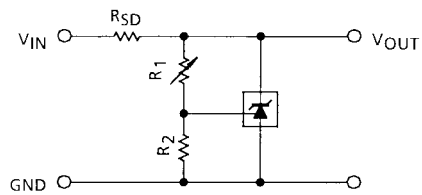

$$V_{OUT} = V_{REF} \left(1 + \frac{R_1}{R_2} \right) + I_{REF} \cdot R_1$$

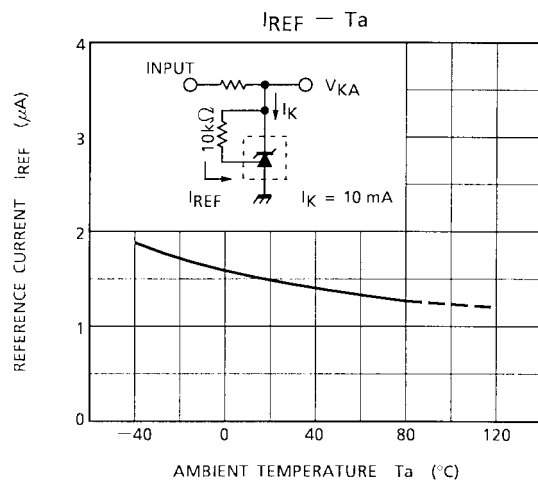
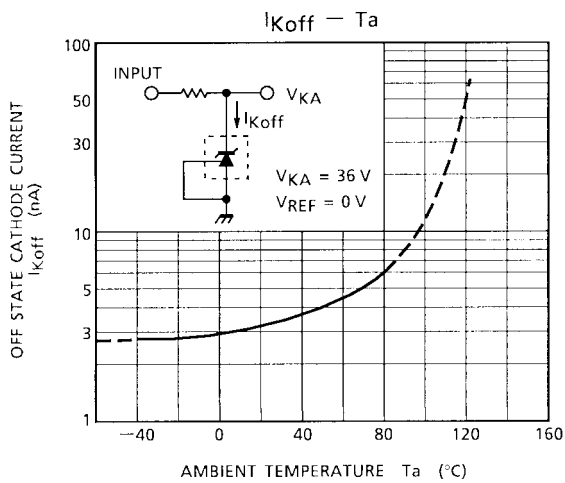
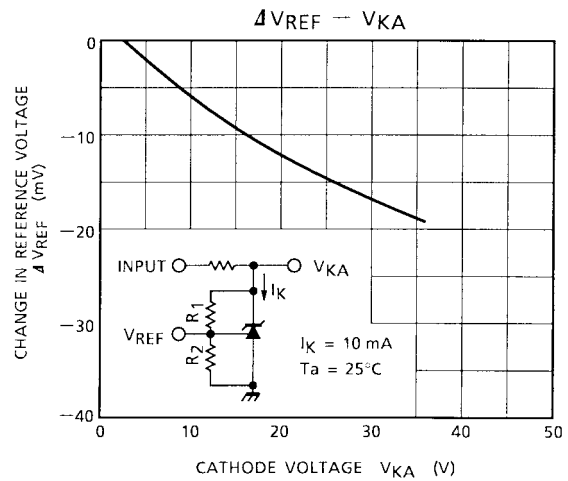
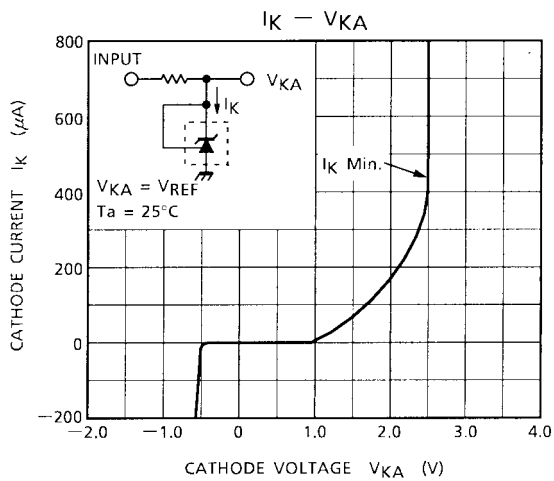
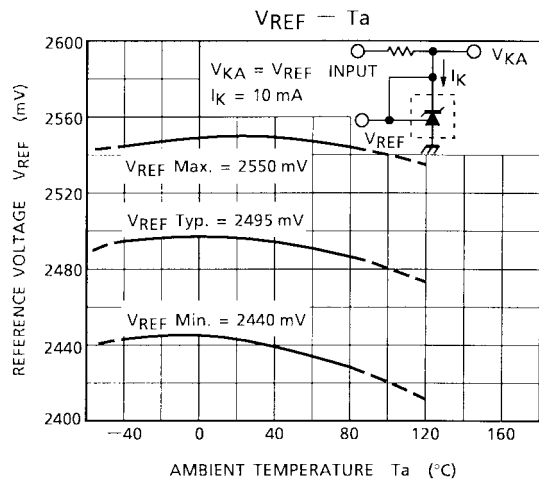
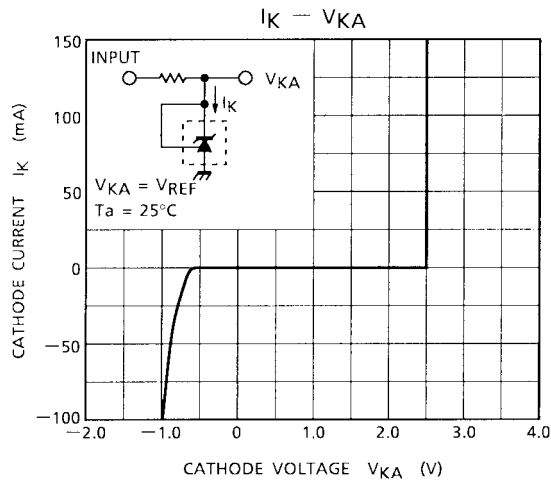

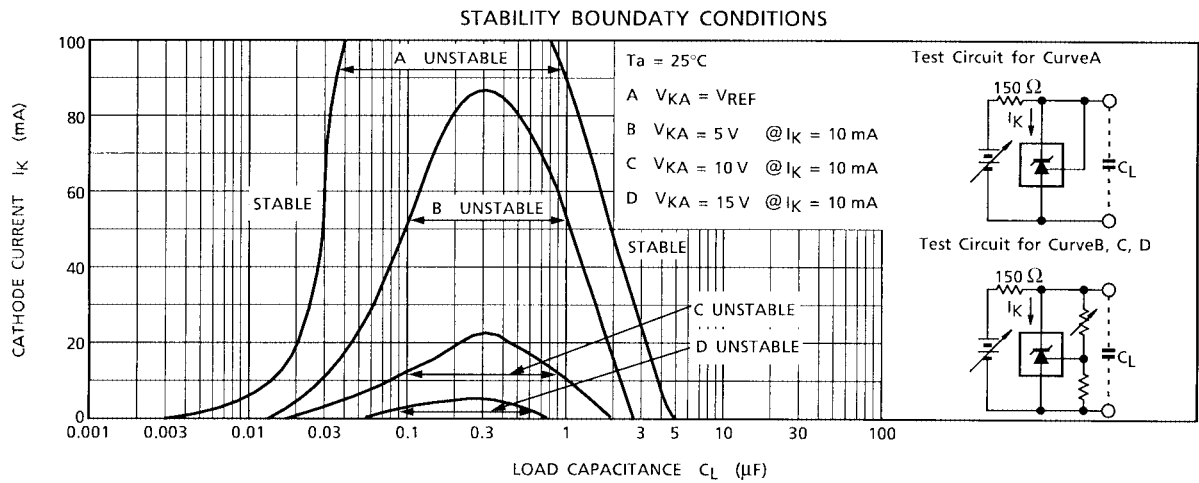
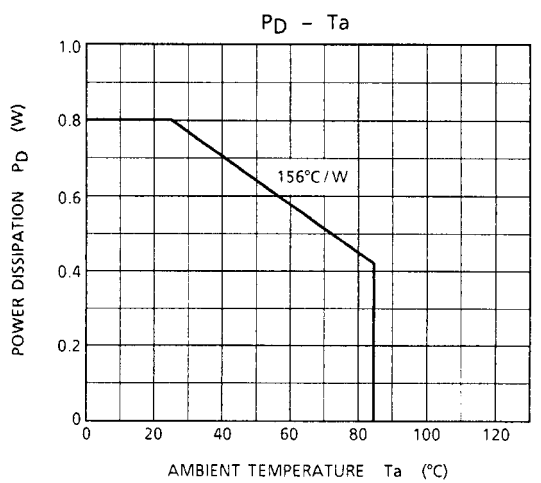
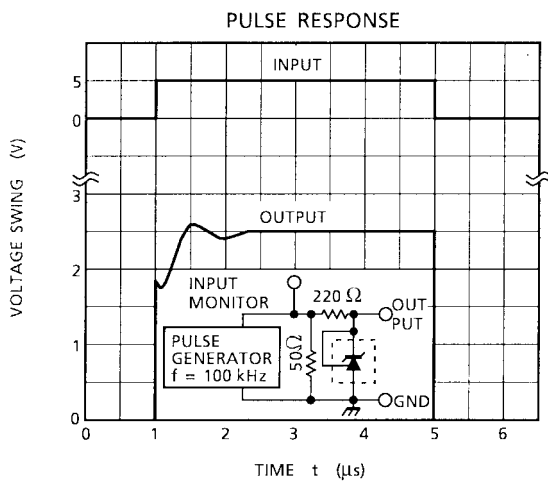
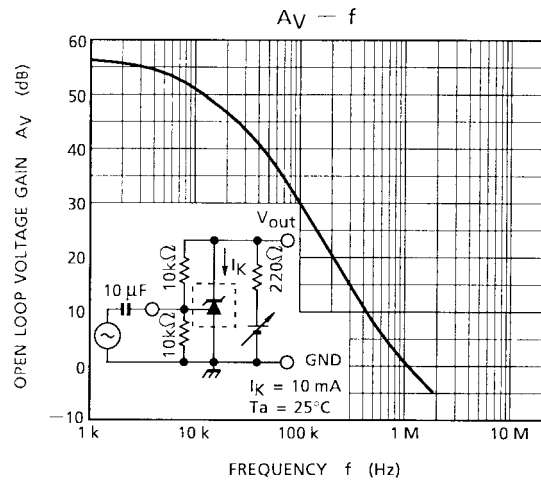
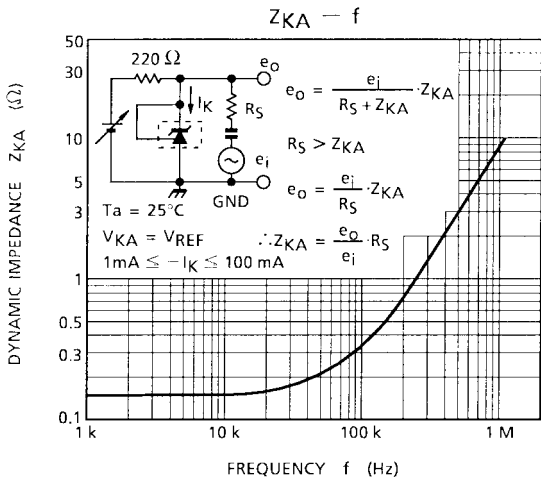

Package Dimensions

SSIP3-P-1.27

Unit : mm

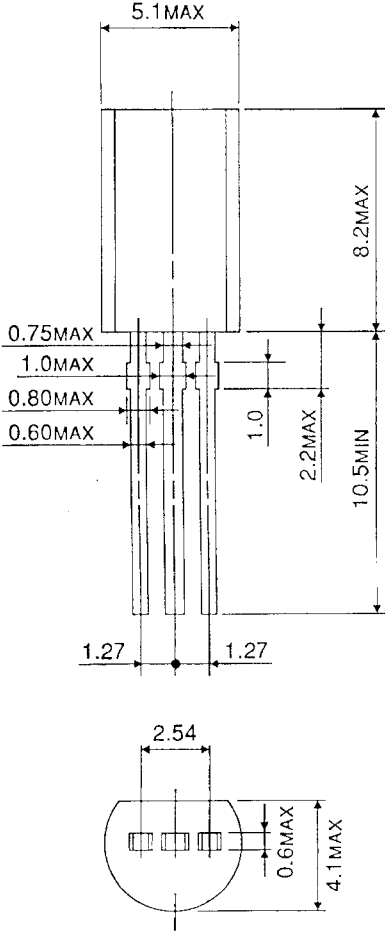

Weight : 0.36 g (Typ.)

RESTRICTIONS ON PRODUCT USE

000707EBA

- TOSHIBA is continually working to improve the quality and reliability of its products. Nevertheless, semiconductor devices in general can malfunction or fail due to their inherent electrical sensitivity and vulnerability to physical stress. It is the responsibility of the buyer, when utilizing TOSHIBA products, to comply with the standards of safety in making a safe design for the entire system, and to avoid situations in which a malfunction or failure of such TOSHIBA products could cause loss of human life, bodily injury or damage to property.
In developing your designs, please ensure that TOSHIBA products are used within specified operating ranges as set forth in the most recent TOSHIBA products specifications. Also, please keep in mind the precautions and conditions set forth in the "Handling Guide for Semiconductor Devices," or "TOSHIBA Semiconductor Reliability Handbook" etc..
- The TOSHIBA products listed in this document are intended for usage in general electronics applications (computer, personal equipment, office equipment, measuring equipment, industrial robotics, domestic appliances, etc.). These TOSHIBA products are neither intended nor warranted for usage in equipment that requires extraordinarily high quality and/or reliability or a malfunction or failure of which may cause loss of human life or bodily injury ("Unintended Usage"). Unintended Usage include atomic energy control instruments, airplane or spaceship instruments, transportation instruments, traffic signal instruments, combustion control instruments, medical instruments, all types of safety devices, etc.. Unintended Usage of TOSHIBA products listed in this document shall be made at the customer's own risk.
- The products described in this document are subject to the foreign exchange and foreign trade laws.
- The information contained herein is presented only as a guide for the applications of our products. No responsibility is assumed by TOSHIBA CORPORATION for any infringements of intellectual property or other rights of the third parties which may result from its use. No license is granted by implication or otherwise under any intellectual property or other rights of TOSHIBA CORPORATION or others.
- The information contained herein is subject to change without notice.