

TOSHIBA Bipolar Linear Integrated Circuit Silicon Monolithic

TA78M05S, TA78M06S, TA78M08S, TA78M09S, TA78M10S, TA78M12S, TA78M15S, TA78M18S, TA78M20S, TA78M24S

Output Current of 0.5 A, Three-Terminal Positive Voltage Regulators
5 V, 6 V, 8 V, 9 V, 10 V, 12 V, 15 V, 18 V, 20 V, 24 V

The TA78M××S series of fixed-voltage monolithic integrated circuit voltage regulators is designed for a wide range of applications. These regulators employ internal current-limiting, thermal-shutdown and safe-area compensation, making them essentially indestructible. One of these regulators can driver up to 0.5 A of output current.

Features

- Suitable for CMOS, TTL and the other digital IC's power supply.
- Maximum output current of 0.5 A.
- Internal thermal overload protection.
- Internal short circuit current limiting.
- Package in the plastic case TO-220NIS.

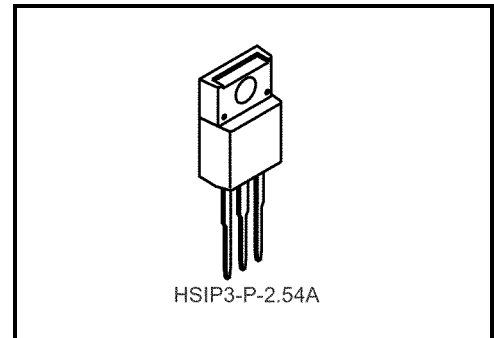

HSIP3-P-2.54A

Weight: 1.7 g (typ.)

Pin Assignment

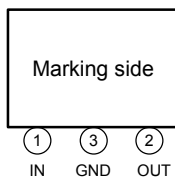

Equivalent Circuit

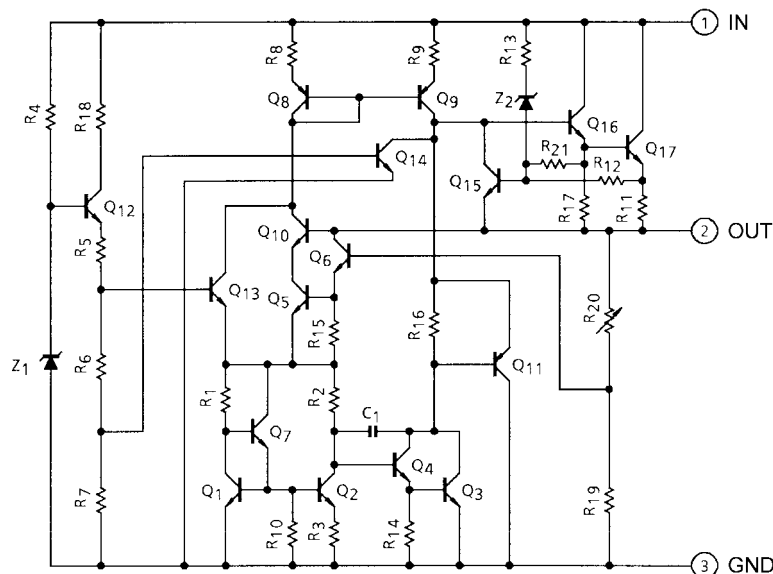

Maximum Ratings (Ta = 25°C)

Characteristics		Symbol	Rating	Unit
Input voltage	TA78M05S	V _{IN}	35	V
	TA78M06S			
	TA78M08S			
	TA78M09S			
	TA78M10S			
	TA78M12S			
	TA78M15S			
	TA78M18S		40	
	TA78M20S			
	TA78M24S			
Power dissipation	(Ta = 25°C)	P _D	2	W
	(Tc = 25°C)		20	
Operating temperature		T _{opr}	-30~85	°C
Storage temperature		T _{stg}	-55~150	°C
Junction temperature		T _j	150	°C
Thermal resistance		R _{th(j-c)}	6.25	°C/W
		R _{th(j-a)}	62.5	

TA78M05S

Electrical Characteristics

(Unless otherwise specified, $V_{IN} = 10\text{ V}$, $I_{OUT} = 350\text{ mA}$, $0^\circ\text{C} \leq T_j \leq 125^\circ\text{C}$, $C_{IN} = 0.33\text{ }\mu\text{F}$, $C_{OUT} = 0.1\text{ }\mu\text{F}$)

Characteristics	Symbol	Test Circuit	Test Condition	Min	Typ.	Max	Unit		
Output voltage	V_{OUT}	1	$T_j = 25^\circ\text{C}$	4.8	5.0	5.2	V		
Line regulation	Reg-line	1	$T_j = 25^\circ\text{C}$	$7\text{ V} \leq V_{IN} \leq 25\text{ V}$, $I_{OUT} = 200\text{ mA}$	—	4	100	mV	
				$8\text{ V} \leq V_{IN} \leq 25\text{ V}$, $I_{OUT} = 200\text{ mA}$	—	2	50		
Load regulation	Reg-load	1	$T_j = 25^\circ\text{C}$	$5\text{ mA} \leq I_{OUT} \leq 500\text{ mA}$	—	25	100	mV	
				$5\text{ mA} \leq I_{OUT} \leq 200\text{ mA}$	—	10	50		
Output voltage	V_{OUT}	1	$T_j = 25^\circ\text{C}$	$7\text{ V} \leq V_{IN} \leq 20\text{ V}$, $5\text{ mA} \leq I_{OUT} \leq 350\text{ mA}$	4.75	—	5.25	V	
Quiescent current	I_B	1	$T_j = 25^\circ\text{C}$	—	4.5	8.0	mA		
Quiescent current change	Line	ΔI_{BI}	1	$T_j = 25^\circ\text{C}$	$8.5\text{ V} \leq V_{IN} \leq 25.5\text{ V}$, $I_{OUT} = 200\text{ mA}$	—	—	0.8	mA
	Load	ΔI_{BO}				1	$5\text{ mA} \leq I_{OUT} \leq 350\text{ mA}$	—	
Output noise voltage	V_{NO}	2	$T_a = 25^\circ\text{C}$, $10\text{ Hz} \leq f \leq 100\text{ kHz}$	—	50	200	μV_{rms}		
Ripple rejection	R.R.	3	$f = 120\text{ Hz}$, $I_{OUT} = 100\text{ mA}$, $8\text{ V} \leq V_{IN} \leq 18\text{ V}$, $T_j = 25^\circ\text{C}$	62	69	—	dB		
Short circuit current limit	I_{SC}	1	$T_j = 25^\circ\text{C}$	—	960	—	mA		
Dropout voltage	V_D	1	$T_j = 25^\circ\text{C}$	—	1.7	—	V		
Average temperature coefficient of output voltage	T_{CVO}	1	$I_{OUT} = 5\text{ mA}$	—	-0.6	—	$\text{mV}/^\circ\text{C}$		

TA78M06S

Electrical Characteristics

(Unless otherwise specified, $V_{IN} = 11\text{ V}$, $I_{OUT} = 350\text{ mA}$, $0^\circ\text{C} \leq T_j \leq 125^\circ\text{C}$, $C_{IN} = 0.33\text{ }\mu\text{F}$, $C_{OUT} = 0.1\text{ }\mu\text{F}$)

Characteristics		Symbol	Test Circuit	Test Condition	Min	Typ.	Max	Unit		
Output voltage		V_{OUT}	1	$T_j = 25^\circ\text{C}$	5.75	6.0	6.25	V		
Line regulation		Reg-line	1	$T_j = 25^\circ\text{C}$	$8\text{ V} \leq V_{IN} \leq 25\text{ V}$, $I_{OUT} = 200\text{ mA}$	—	4	100	mV	
					$9\text{ V} \leq V_{IN} \leq 25\text{ V}$, $I_{OUT} = 200\text{ mA}$	—	2	50		
Load regulation		Reg-load	1	$T_j = 25^\circ\text{C}$	$5\text{ mA} \leq I_{OUT} \leq 500\text{ mA}$	—	25	120	mV	
					$5\text{ mA} \leq I_{OUT} \leq 200\text{ mA}$	—	10	60		
Output voltage		V_{OUT}	1	$T_j = 25^\circ\text{C}$	$8\text{ V} \leq V_{IN} \leq 21\text{ V}$, $5\text{ mA} \leq I_{OUT} \leq 350\text{ mA}$	5.7	—	6.3	V	
Quiescent current		I_B	1	$T_j = 25^\circ\text{C}$	—	4.5	8.0	mA		
Quiescent current change		Line	ΔI_{BI}	1	$T_j = 25^\circ\text{C}$	$9.5\text{ V} \leq V_{IN} \leq 25.5\text{ V}$, $I_{OUT} = 200\text{ mA}$	—	—	0.8	mA
		Load	ΔI_{BO}				1	$5\text{ mA} \leq I_{OUT} \leq 350\text{ mA}$	—	
Output noise voltage		V_{NO}	2	$T_a = 25^\circ\text{C}$, $10\text{ Hz} \leq f \leq 100\text{ kHz}$	—	55	220	μV_{rms}		
Ripple rejection		R.R.	3	$f = 120\text{ Hz}$, $I_{OUT} = 100\text{ mA}$, $9\text{ V} \leq V_{IN} \leq 19\text{ V}$, $T_j = 25^\circ\text{C}$	59	66	—	dB		
Short circuit current limit		I_{SC}	1	$T_j = 25^\circ\text{C}$	—	960	—	mA		
Dropout voltage		V_D	1	$T_j = 25^\circ\text{C}$	—	1.7	—	V		
Average temperature coefficient of output voltage		T_{CVO}	1	$I_{OUT} = 5\text{ mA}$	—	-0.7	—	$\text{mV}/^\circ\text{C}$		

TA78M08S

Electrical Characteristics

(Unless otherwise specified, $V_{IN} = 14\text{ V}$, $I_{OUT} = 350\text{ mA}$, $0^\circ\text{C} \leq T_j \leq 125^\circ\text{C}$, $C_{IN} = 0.33\text{ }\mu\text{F}$, $C_{OUT} = 0.1\text{ }\mu\text{F}$)

Characteristics	Symbol	Test Circuit	Test Condition	Min	Typ.	Max	Unit		
Output voltage	V_{OUT}	1	$T_j = 25^\circ\text{C}$	7.7	8.0	8.3	V		
Line regulation	Reg-line	1	$T_j = 25^\circ\text{C}$	$10.5\text{ V} \leq V_{IN} \leq 25\text{ V}$, $I_{OUT} = 200\text{ mA}$	—	5	100	mV	
				$11\text{ V} \leq V_{IN} \leq 25\text{ V}$, $I_{OUT} = 200\text{ mA}$	—	3	50		
Load regulation	Reg-load	1	$T_j = 25^\circ\text{C}$	$5\text{ mA} \leq I_{OUT} \leq 500\text{ mA}$	—	26	160	mV	
				$5\text{ mA} \leq I_{OUT} \leq 200\text{ mA}$	—	10	80		
Output voltage	V_{OUT}	1	$T_j = 25^\circ\text{C}$	$10.5\text{ V} \leq V_{IN} \leq 23\text{ V}$, $5\text{ mA} \leq I_{OUT} \leq 350\text{ mA}$	7.6	—	8.4	V	
Quiescent current	I_B	1	$T_j = 25^\circ\text{C}$	—	4.6	8.0	mA		
Quiescent current change	Line	ΔI_{BI}	1	$T_j = 25^\circ\text{C}$	$11\text{ V} \leq V_{IN} \leq 25.5\text{ V}$, $I_{OUT} = 200\text{ mA}$	—	—	0.8	mA
	Load	ΔI_{BO}				1	$5\text{ mA} \leq I_{OUT} \leq 350\text{ mA}$	—	
Output noise voltage	V_{NO}	2	$T_a = 25^\circ\text{C}$, $10\text{ Hz} \leq f \leq 100\text{ kHz}$	—	60	250	μV_{rms}		
Ripple rejection	R.R.	3	$f = 120\text{ Hz}$, $I_{OUT} = 100\text{ mA}$, $11.5\text{ V} \leq V_{IN} \leq 21.5\text{ V}$, $T_j = 25^\circ\text{C}$	56	63	—	dB		
Short circuit current limit	I_{SC}	1	$T_j = 25^\circ\text{C}$	—	960	—	mA		
Dropout voltage	V_D	1	$T_j = 25^\circ\text{C}$	—	1.7	—	V		
Average temperature coefficient of output voltage	T_{CVO}	1	$I_{OUT} = 5\text{ mA}$	—	-1.0	—	$\text{mV}/^\circ\text{C}$		

TA78M09S

Electrical Characteristics

(Unless otherwise specified, $V_{IN} = 15\text{ V}$, $I_{OUT} = 350\text{ mA}$, $0^\circ\text{C} \leq T_j \leq 125^\circ\text{C}$, $C_{IN} = 0.33\text{ }\mu\text{F}$, $C_{OUT} = 0.1\text{ }\mu\text{F}$)

Characteristics	Symbol	Test Circuit	Test Condition	Min	Typ.	Max	Unit		
Output voltage	V_{OUT}	1	$T_j = 25^\circ\text{C}$	8.64	9.0	9.36	V		
Line regulation	Reg-line	1	$T_j = 25^\circ\text{C}$	$11.5\text{ V} \leq V_{IN} \leq 26\text{ V}$, $I_{OUT} = 200\text{ mA}$	—	5	100	mV	
				$13\text{ V} \leq V_{IN} \leq 26\text{ V}$, $I_{OUT} = 200\text{ mA}$	—	3	50		
Load regulation	Reg-load	1	$T_j = 25^\circ\text{C}$	$5\text{ mA} \leq I_{OUT} \leq 500\text{ mA}$	—	26	180	mV	
				$5\text{ mA} \leq I_{OUT} \leq 200\text{ mA}$	—	10	90		
Output voltage	V_{OUT}	1	$T_j = 25^\circ\text{C}$	$11.5\text{ V} \leq V_{IN} \leq 24\text{ V}$, $5\text{ mA} \leq I_{OUT} \leq 350\text{ mA}$	8.55	—	9.45	V	
Quiescent current	I_B	1	$T_j = 25^\circ\text{C}$	—	4.6	8.0	mA		
Quiescent current change	Line	ΔI_{BI}	1	$T_j = 25^\circ\text{C}$	$12\text{ V} \leq V_{IN} \leq 26.5\text{ V}$, $I_{OUT} = 200\text{ mA}$	—	—	0.8	mA
	Load	ΔI_{BO}				1	$5\text{ mA} \leq I_{OUT} \leq 350\text{ mA}$	—	
Output noise voltage	V_{NO}	2	$T_a = 25^\circ\text{C}$, $10\text{ Hz} \leq f \leq 100\text{ kHz}$	—	60	270	μV_{rms}		
Ripple rejection	R.R.	3	$f = 120\text{ Hz}$, $I_{OUT} = 100\text{ mA}$, $12.5\text{ V} \leq V_{IN} \leq 22.5\text{ V}$, $T_j = 25^\circ\text{C}$	56	63	—	dB		
Short circuit current limit	I_{SC}	1	$T_j = 25^\circ\text{C}$	—	960	—	mA		
Dropout voltage	V_D	1	$T_j = 25^\circ\text{C}$	—	1.7	—	V		
Average temperature coefficient of output voltage	T_{CVO}	1	$I_{OUT} = 5\text{ mA}$	—	-1.1	—	$\text{mV}/^\circ\text{C}$		

TA78M10S

Electrical Characteristics

(Unless otherwise specified, $V_{IN} = 16\text{ V}$, $I_{OUT} = 350\text{ mA}$, $0^\circ\text{C} \leq T_j \leq 125^\circ\text{C}$, $C_{IN} = 0.33\text{ }\mu\text{F}$, $C_{OUT} = 0.1\text{ }\mu\text{F}$)

Characteristics	Symbol	Test Circuit	Test Condition	Min	Typ.	Max	Unit		
Output voltage	V_{OUT}	1	$T_j = 25^\circ\text{C}$	9.6	10.0	10.4	V		
Line regulation	Reg-line	1	$T_j = 25^\circ\text{C}$	$12.5\text{ V} \leq V_{IN} \leq 26\text{ V}$, $I_{OUT} = 200\text{ mA}$	—	6	100	mV	
				$14\text{ V} \leq V_{IN} \leq 26\text{ V}$, $I_{OUT} = 200\text{ mA}$	—	3	50		
Load regulation	Reg-load	1	$T_j = 25^\circ\text{C}$	$5\text{ mA} \leq I_{OUT} \leq 500\text{ mA}$	—	26	200	mV	
				$5\text{ mA} \leq I_{OUT} \leq 200\text{ mA}$	—	10	100		
Output voltage	V_{OUT}	1	$T_j = 25^\circ\text{C}$	$12.5\text{ V} \leq V_{IN} \leq 25\text{ V}$, $5\text{ mA} \leq I_{OUT} \leq 350\text{ mA}$	9.5	—	10.5	V	
Quiescent current	I_B	1	$T_j = 25^\circ\text{C}$	—	4.7	8.0	mA		
Quiescent current change	Line	ΔI_{BI}	1	$T_j = 25^\circ\text{C}$	$13\text{ V} \leq V_{IN} \leq 26.5\text{ V}$, $I_{OUT} = 200\text{ mA}$	—	—	0.8	mA
	Load	ΔI_{BO}				1	$5\text{ mA} \leq I_{OUT} \leq 350\text{ mA}$	—	
Output noise voltage	V_{NO}	2	$T_a = 25^\circ\text{C}$, $10\text{ Hz} \leq f \leq 100\text{ kHz}$	—	65	280	μV_{rms}		
Ripple rejection	R.R.	3	$f = 120\text{ Hz}$, $I_{OUT} = 100\text{ mA}$, $13.5\text{ V} \leq V_{IN} \leq 23.5\text{ V}$, $T_j = 25^\circ\text{C}$	55	62	—	dB		
Short circuit current limit	I_{SC}	1	$T_j = 25^\circ\text{C}$	—	960	—	mA		
Dropout voltage	V_D	1	$T_j = 25^\circ\text{C}$	—	1.7	—	V		
Average temperature coefficient of output voltage	T_{CVO}	1	$I_{OUT} = 5\text{ mA}$	—	-1.3	—	$\text{mV}/^\circ\text{C}$		

TA78M12S

Electrical Characteristics

(Unless otherwise specified, $V_{IN} = 19\text{ V}$, $I_{OUT} = 350\text{ mA}$, $0^\circ\text{C} \leq T_j \leq 125^\circ\text{C}$, $C_{IN} = 0.33\text{ }\mu\text{F}$, $C_{OUT} = 0.1\text{ }\mu\text{F}$)

Characteristics		Symbol	Test Circuit	Test Condition	Min	Typ.	Max	Unit
Output voltage		V_{OUT}	1	$T_j = 25^\circ\text{C}$	11.5	12.0	12.5	V
Line regulation	Reg-line	1	$T_j = 25^\circ\text{C}$	$14.5\text{ V} \leq V_{IN} \leq 30\text{ V}$, $I_{OUT} = 200\text{ mA}$	—	7	100	mV
				$16\text{ V} \leq V_{IN} \leq 30\text{ V}$, $I_{OUT} = 200\text{ mA}$	—	3	50	
Load regulation	Reg-load	1	$T_j = 25^\circ\text{C}$	$5\text{ mA} \leq I_{OUT} \leq 500\text{ mA}$	—	27	240	mV
				$5\text{ mA} \leq I_{OUT} \leq 200\text{ mA}$	—	10	120	
Output voltage		V_{OUT}	1	$T_j = 25^\circ\text{C}$ $14.5\text{ V} \leq V_{IN} \leq 27\text{ V}$, $5\text{ mA} \leq I_{OUT} \leq 350\text{ mA}$	11.4	—	12.6	V
Quiescent current		I_B	1	$T_j = 25^\circ\text{C}$	—	4.8	8.0	mA
Quiescent current change	Line	ΔI_{BI}	1	$T_j = 25^\circ\text{C}$ $15\text{ V} \leq V_{IN} \leq 30.5\text{ V}$, $I_{OUT} = 200\text{ mA}$	—	—	0.8	mA
	Load	ΔI_{BO}	1		$5\text{ mA} \leq I_{OUT} \leq 350\text{ mA}$	—	—	
Output noise voltage		V_{NO}	2	$T_a = 25^\circ\text{C}$, $10\text{ Hz} \leq f \leq 100\text{ kHz}$	—	70	300	μV_{rms}
Ripple rejection		R.R.	3	$f = 120\text{ Hz}$, $I_{OUT} = 100\text{ mA}$, $15\text{ V} \leq V_{IN} \leq 25\text{ V}$, $T_j = 25^\circ\text{C}$	55	62	—	dB
Short circuit current limit		I_{SC}	1	$T_j = 25^\circ\text{C}$	—	960	—	mA
Dropout voltage		V_D	1	$T_j = 25^\circ\text{C}$	—	1.7	—	V
Average temperature coefficient of output voltage		T_{CVO}	1	$I_{OUT} = 5\text{ mA}$	—	-1.6	—	$\text{mV}/^\circ\text{C}$

TA78M15S

Electrical Characteristics

(Unless otherwise specified, $V_{IN} = 23\text{ V}$, $I_{OUT} = 350\text{ mA}$, $0^\circ\text{C} \leq T_j \leq 125^\circ\text{C}$, $C_{IN} = 0.33\ \mu\text{F}$, $C_{OUT} = 0.1\ \mu\text{F}$)

Characteristics		Symbol	Test Circuit	Test Condition	Min	Typ.	Max	Unit	
Output voltage		V_{OUT}	1	$T_j = 25^\circ\text{C}$	14.4	15.0	15.6	V	
Line regulation		Reg-line	1	$T_j = 25^\circ\text{C}$	$17.5\text{ V} \leq V_{IN} \leq 30\text{ V}$, $I_{OUT} = 200\text{ mA}$	—	8	100	mV
					$20\text{ V} \leq V_{IN} \leq 30\text{ V}$, $I_{OUT} = 200\text{ mA}$	—	4	50	
Load regulation		Reg-load	1	$T_j = 25^\circ\text{C}$	$5\text{ mA} \leq I_{OUT} \leq 500\text{ mA}$	—	27	300	mV
					$5\text{ mA} \leq I_{OUT} \leq 200\text{ mA}$	—	10	150	
Output voltage		V_{OUT}	1	$T_j = 25^\circ\text{C}$	$17.5\text{ V} \leq V_{IN} \leq 30\text{ V}$, $5\text{ mA} \leq I_{OUT} \leq 350\text{ mA}$	14.25	—	15.75	V
Quiescent current		I_B	1	$T_j = 25^\circ\text{C}$	—	4.8	8.0	mA	
Quiescent current change		Line	ΔI_{BI}	1	$T_j = 25^\circ\text{C}$	—	—	0.8	mA
		Load	ΔI_{BO}	1					
Output noise voltage		V_{NO}	2	$T_a = 25^\circ\text{C}$, $10\text{ Hz} \leq f \leq 100\text{ kHz}$	—	80	450	μV_{rms}	
Ripple rejection		R.R.	3	$f = 120\text{ Hz}$, $I_{OUT} = 100\text{ mA}$, $18.5\text{ V} \leq V_{IN} \leq 28.5\text{ V}$, $T_j = 25^\circ\text{C}$	54	61	—	dB	
Short circuit current limit		I_{SC}	1	$T_j = 25^\circ\text{C}$	—	960	—	mA	
Dropout voltage		V_D	1	$T_j = 25^\circ\text{C}$	—	1.7	—	V	
Average temperature coefficient of output voltage		T_{CVO}	1	$I_{OUT} = 5\text{ mA}$	—	-2.0	—	$\text{mV}/^\circ\text{C}$	

TA78M18S

Electrical Characteristics

(Unless otherwise specified, $V_{IN} = 27\text{ V}$, $I_{OUT} = 350\text{ mA}$, $0^\circ\text{C} \leq T_j \leq 125^\circ\text{C}$, $C_{IN} = 0.33\ \mu\text{F}$, $C_{OUT} = 0.1\ \mu\text{F}$)

Characteristics	Symbol	Test Circuit	Test Condition	Min	Typ.	Max	Unit		
Output voltage	V_{OUT}	1	$T_j = 25^\circ\text{C}$	17.3	18.0	18.7	V		
Line regulation	Reg-line	1	$T_j = 25^\circ\text{C}$	$21\text{ V} \leq V_{IN} \leq 33\text{ V}$, $I_{OUT} = 200\text{ mA}$	—	9	100	mV	
				$24\text{ V} \leq V_{IN} \leq 33\text{ V}$, $I_{OUT} = 200\text{ mA}$	—	5	50		
Load regulation	Reg-load	1	$T_j = 25^\circ\text{C}$	$5\text{ mA} \leq I_{OUT} \leq 500\text{ mA}$	—	28	360	mV	
				$5\text{ mA} \leq I_{OUT} \leq 200\text{ mA}$	—	10	180		
Output voltage	V_{OUT}	1	$T_j = 25^\circ\text{C}$	$21\text{ V} \leq V_{IN} \leq 33\text{ V}$, $5\text{ mA} \leq I_{OUT} \leq 350\text{ mA}$	17.1	—	18.9	V	
Quiescent current	I_B	1	$T_j = 25^\circ\text{C}$	—	4.8	8.0	mA		
Quiescent current change	Line	ΔI_{BI}	1	$T_j = 25^\circ\text{C}$	$21.5\text{ V} \leq V_{IN} \leq 33.5\text{ V}$, $I_{OUT} = 200\text{ mA}$	—	—	0.8	mA
	Load	ΔI_{BO}				1	$5\text{ mA} \leq I_{OUT} \leq 350\text{ mA}$	—	
Output noise voltage	V_{NO}	2	$T_a = 25^\circ\text{C}$, $10\text{ Hz} \leq f \leq 100\text{ kHz}$	—	90	490	μV_{rms}		
Ripple rejection	R.R.	3	$f = 120\text{ Hz}$, $I_{OUT} = 100\text{ mA}$, $22\text{ V} \leq V_{IN} \leq 32\text{ V}$, $T_j = 25^\circ\text{C}$	53	60	—	dB		
Short circuit current limit	I_{SC}	1	$T_j = 25^\circ\text{C}$	—	960	—	mA		
Dropout voltage	V_D	1	$T_j = 25^\circ\text{C}$	—	1.7	—	V		
Average temperature coefficient of output voltage	T_{CVO}	1	$I_{OUT} = 5\text{ mA}$	—	-2.5	—	$\text{mV}/^\circ\text{C}$		

TA78M20S

Electrical Characteristics

(Unless otherwise specified, $V_{IN} = 29\text{ V}$, $I_{OUT} = 350\text{ mA}$, $0^\circ\text{C} \leq T_j \leq 125^\circ\text{C}$, $C_{IN} = 0.33\text{ }\mu\text{F}$, $C_{OUT} = 0.1\text{ }\mu\text{F}$)

Characteristics	Symbol	Test Circuit	Test Condition	Min	Typ.	Max	Unit		
Output voltage	V_{OUT}	1	$T_j = 25^\circ\text{C}$	19.2	20.0	20.8	V		
Line regulation	Reg-line	1	$T_j = 25^\circ\text{C}$	$23\text{ V} \leq V_{IN} \leq 35\text{ V}$, $I_{OUT} = 200\text{ mA}$	—	10	100	mV	
				$24\text{ V} \leq V_{IN} \leq 35\text{ V}$, $I_{OUT} = 200\text{ mA}$	—	6	50		
Load regulation	Reg-load	1	$T_j = 25^\circ\text{C}$	$5\text{ mA} \leq I_{OUT} \leq 500\text{ mA}$	—	28	400	mV	
				$5\text{ mA} \leq I_{OUT} \leq 200\text{ mA}$	—	10	200		
Output voltage	V_{OUT}	1	$T_j = 25^\circ\text{C}$	$23\text{ V} \leq V_{IN} \leq 35\text{ V}$, $5\text{ mA} \leq I_{OUT} \leq 350\text{ mA}$	19.0	—	21.0	V	
Quiescent current	I_B	1	$T_j = 25^\circ\text{C}$	—	4.9	8.0	mA		
Quiescent current change	Line	ΔI_{BI}	1	$T_j = 25^\circ\text{C}$	$23.5\text{ V} \leq V_{IN} \leq 35.5\text{ V}$, $I_{OUT} = 200\text{ mA}$	—	—	0.8	mA
	Load	ΔI_{BO}				1	$5\text{ mA} \leq I_{OUT} \leq 350\text{ mA}$	—	
Output noise voltage	V_{NO}	2	$T_a = 25^\circ\text{C}$, $10\text{ Hz} \leq f \leq 100\text{ kHz}$	—	95	540	μV_{rms}		
Ripple rejection	R.R.	3	$f = 120\text{ Hz}$, $I_{OUT} = 100\text{ mA}$, $24\text{ V} \leq V_{IN} \leq 34\text{ V}$, $T_j = 25^\circ\text{C}$	53	60	—	dB		
Short circuit current limit	I_{SC}	1	$T_j = 25^\circ\text{C}$	—	960	—	mA		
Dropout voltage	V_D	1	$T_j = 25^\circ\text{C}$	—	1.7	—	V		
Average temperature coefficient of output voltage	T_{CVO}	1	$I_{OUT} = 5\text{ mA}$	—	-3.0	—	$\text{mV}/^\circ\text{C}$		

TA78M24S

Electrical Characteristics

(Unless otherwise specified, $V_{IN} = 33\text{ V}$, $I_{OUT} = 350\text{ mA}$, $0^\circ\text{C} \leq T_j \leq 125^\circ\text{C}$, $C_{IN} = 0.33\text{ }\mu\text{F}$, $C_{OUT} = 0.1\text{ }\mu\text{F}$)

Characteristics	Symbol	Test Circuit	Test Condition	Min	Typ.	Max	Unit		
Output voltage	V_{OUT}	1	$T_j = 25^\circ\text{C}$	23.0	24.0	25.0	V		
Line regulation	Reg-line	1	$T_j = 25^\circ\text{C}$	$27\text{ V} \leq V_{IN} \leq 38\text{ V}$, $I_{OUT} = 200\text{ mA}$	—	12	100	mV	
				$28\text{ V} \leq V_{IN} \leq 38\text{ V}$, $I_{OUT} = 200\text{ mA}$	—	7	50		
Load regulation	Reg-load	1	$T_j = 25^\circ\text{C}$	$5\text{ mA} \leq I_{OUT} \leq 500\text{ mA}$	—	30	480	mV	
				$5\text{ mA} \leq I_{OUT} \leq 200\text{ mA}$	—	10	240		
Output voltage	V_{OUT}	1	$T_j = 25^\circ\text{C}$	$27\text{ V} \leq V_{IN} \leq 38\text{ V}$, $5\text{ mA} \leq I_{OUT} \leq 350\text{ mA}$	22.8	—	25.2	V	
Quiescent current	I_B	1	$T_j = 25^\circ\text{C}$	—	5.0	8.0	mA		
Quiescent current change	Line	ΔI_{BI}	1	$T_j = 25^\circ\text{C}$	$27.5\text{ V} \leq V_{IN} \leq 38.5\text{ V}$, $I_{OUT} = 200\text{ mA}$	—	—	0.8	mA
	Load	ΔI_{BO}				1	$5\text{ mA} \leq I_{OUT} \leq 350\text{ mA}$	—	
Output noise voltage	V_{NO}	2	$T_a = 25^\circ\text{C}$, $10\text{ Hz} \leq f \leq 100\text{ kHz}$	—	115	650	μV_{rms}		
Ripple rejection	R.R.	3	$f = 120\text{ Hz}$, $I_{OUT} = 100\text{ mA}$, $28\text{ V} \leq V_{IN} \leq 38\text{ V}$, $T_j = 25^\circ\text{C}$	50	57	—	dB		
Short circuit current limit	I_{SC}	1	$T_j = 25^\circ\text{C}$	—	960	—	mA		
Dropout voltage	V_D	1	$T_j = 25^\circ\text{C}$	—	1.7	—	V		
Average temperature coefficient of output voltage	T_{CVO}	1	$I_{OUT} = 5\text{ mA}$	—	-3.5	—	$\text{mV}/^\circ\text{C}$		

Test Circuit 1/Standard Application

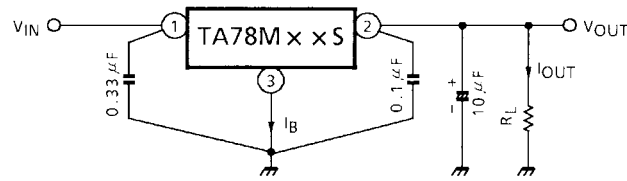

Test Circuit 2

V_{NO}

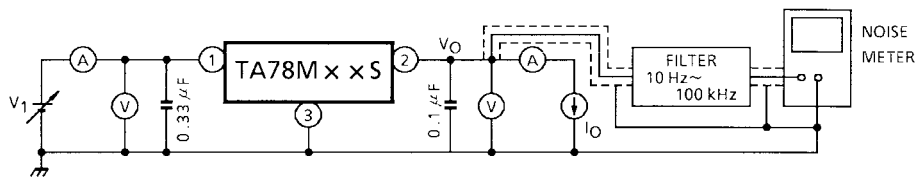

Test Circuit 3

R.R.

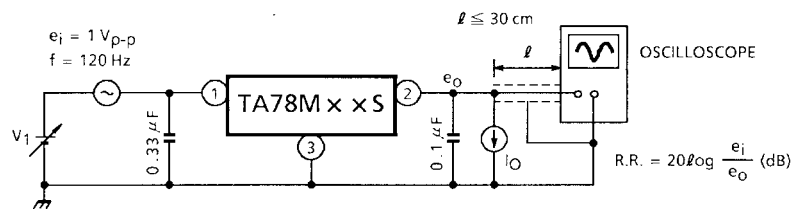

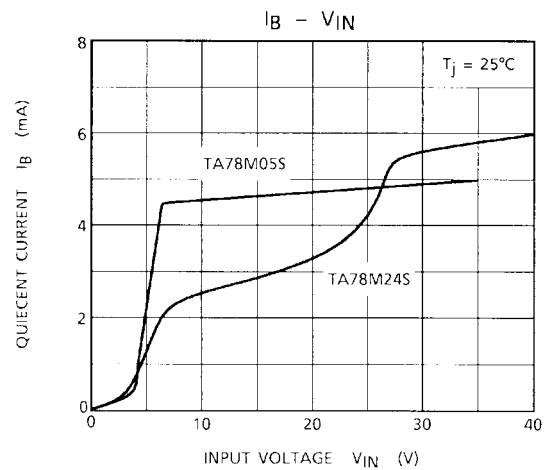
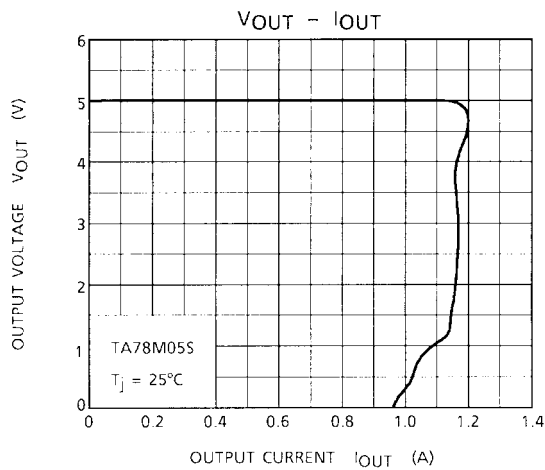
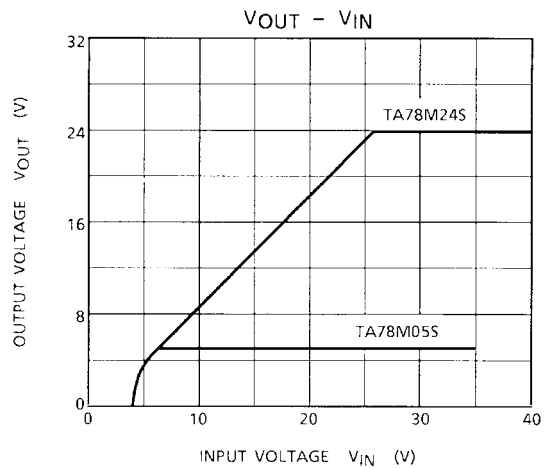
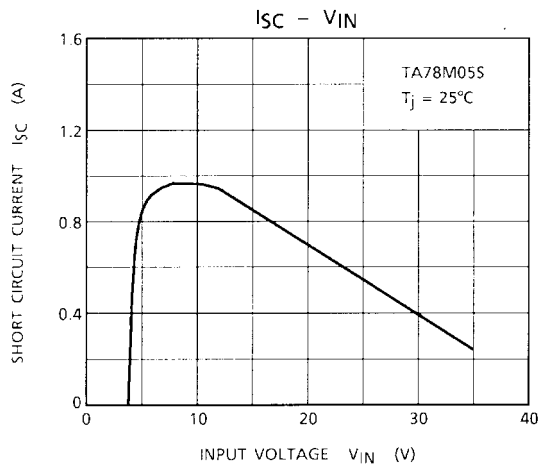
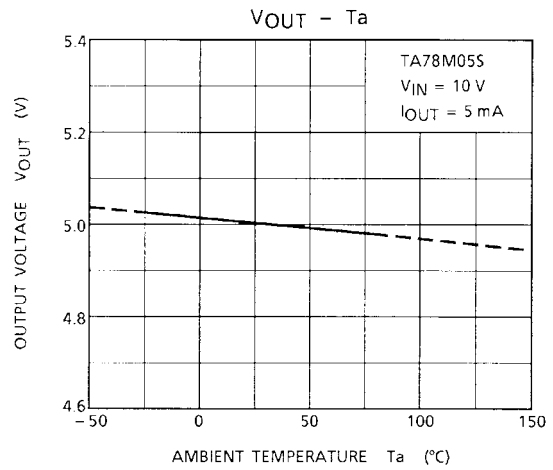
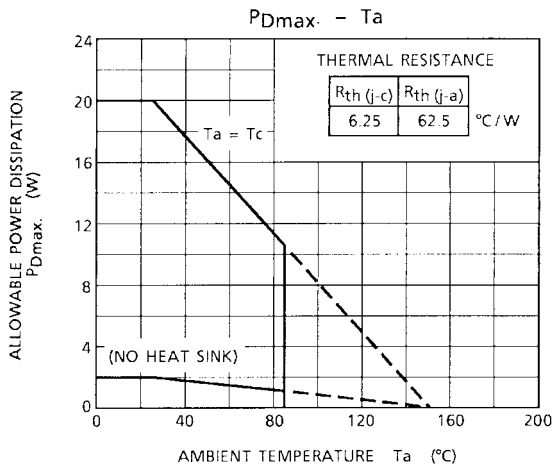

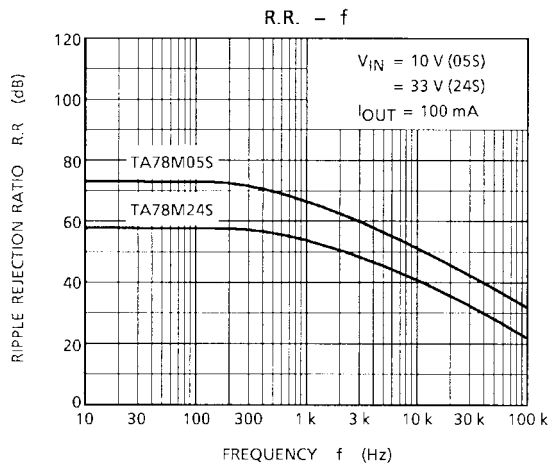
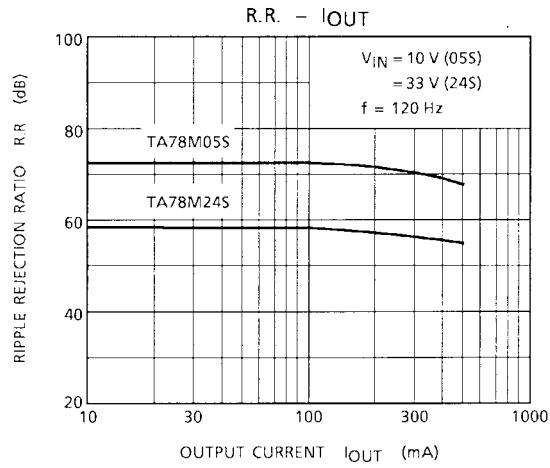
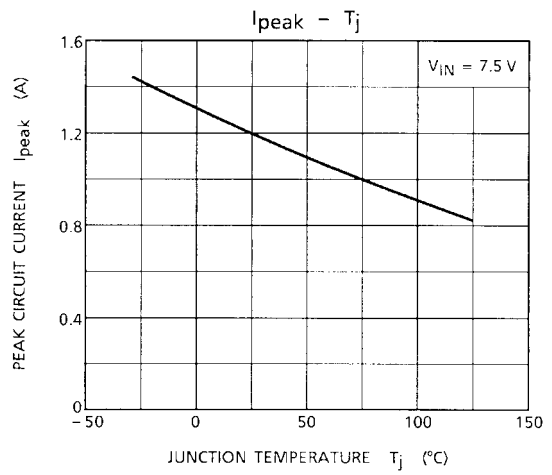
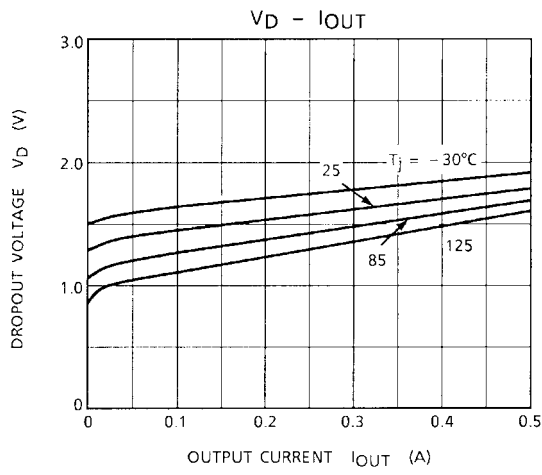

Precautions on Application

- (1) In regard to GND, be careful not to apply a negative voltage to the input/output terminal. Further, special care is necessary in case of a voltage boost application.
- (2) When a surge voltage exceeding maximum rating is applied to the input terminal or when a voltage in excess of the input terminal voltage is applied to the output terminal, the circuit may be destroyed. Specially, in the latter case, great care is necessary. Further, if the input terminal sorts to GND in a state of normal operation, the output terminal voltage becomes higher than the input voltage (GND potential), and the electric charge of a chemical capacitor connected to the output terminal flows into the input side, which may cause the destruction of circuit. In these cases, take such steps as a zener diode and a general silicon diode are connected to the circuit, as shown in the following figure.

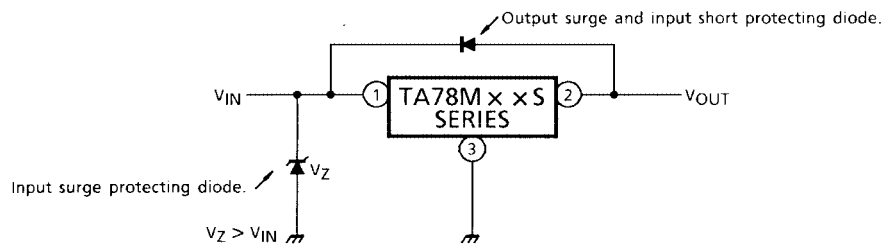

- (3) When the input voltage is too high, the power dissipation of three terminal regulator increases because of series regulator, so that the junction temperature rises. In such a case, it is recommended to reduce the power dissipation by inserting the power limiting resistor R_{SD} in the input terminal, and to reduce the junction temperature as a result.

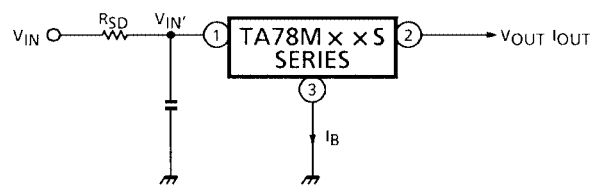

The power dissipation P_D of IC is expressed in the following equation.

$$P_D = (V_{IN'} - V_{OUT}) \cdot I_{OUT} + V_{IN'} \cdot I_B$$

If $V_{IN'}$ is reduced below the lowest voltage necessary for the IC, the parasitic oscillation will be caused according to circumstances.

In determining the resistance value of R_{SD} , design with margin should be made by making reference to the following equation.

$$R_{SD} < \frac{V_{IN} - V_{IN'}}{I_{OUT} + I_B}$$

- (4) Connect the input terminal and GND, and the output terminal and GND, by capacitor respectively. The capacitances should be determined experimentally because they depend on printed circuit board patterns. In particular, adequate investigation should be made so that there is no problem even at time of high or low temperature.
- (5) Installation of IC for power supply

For obtaining high reliability on the heat sink design of the regulator IC, it is generally required to derate more than 20% of maximum junction temperature ($T_j \text{ max}$).

Further, full consideration should be given to the installation of IC to the heat sink.

 - (a) Heat sink design

The thermal resistance of IC itself is required from the viewpoint of the design of elements, but the thermal resistance from the IC package to the open air varies with the contact thermal resistance.

Table 1 shows how much the value of the contact thermal resistance ($\theta_c + \theta_s$) is changed by heat sink grease.

Table 1 Unit: °C/W

Package	Model No	Torque	Mica	$\theta_c + \theta_s$
TO-220NIS	TA78M××S	0.6 N·m	Not provided	0.3~0.5 (1.5~2.0)

The figures given in parentheses denote the values at time of no grease.

(b) Silicon grease

When a circuit not exceeding maximum rating is designed, it is to be desired that the grease should be used if possible. If it is required that the contact thermal resistance is reduced from the viewpoint of the circuit design, it is recommended that the following methods be adopted.

A: Use YG6260 (TOSHIBA SILICON CORPORATION), if grease is used.

(c) Torque

When installing IC on a heat sink or the like, tighten the IC with the torque of less than the rated value. If it is tightened with the torque in excess of the rated value, sometimes the internal elements of the IC are adversely affected. Therefore, great care should be given to the installing operation.

Application Circuits

(1) Voltage Boost Regulator

(a) Voltage boost by use of zener diode

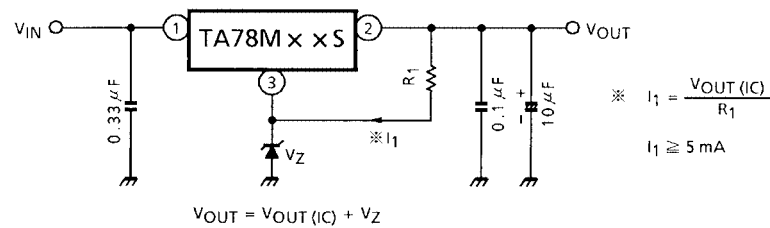

(b) Voltage boost by use of resistor

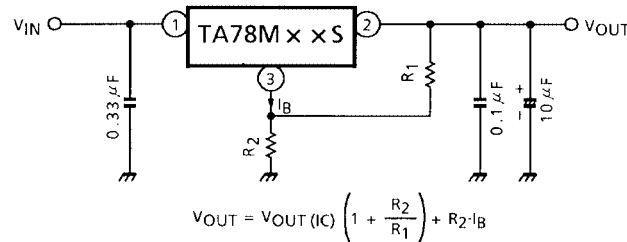

(c) Adjustable output regulator

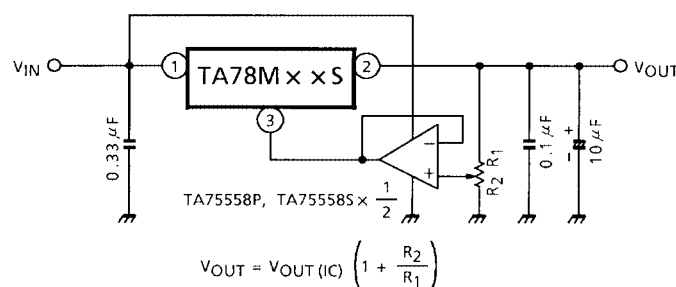

(2) Current Boost Regulator

(a) Current boost voltage regulator

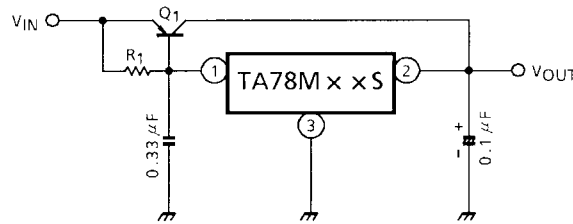

Heat sink is needed for Q1

$$R1 \approx \frac{V_{BE1}}{I_B \text{ MAX}}$$

where,

V_{BE1} : V_{BE} of external transistor Q1.

$I_B \text{ MAX}$: Quiescent current of IC.

(b) Short.circuit protection

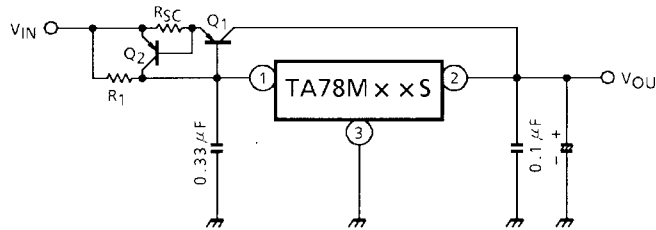

$$R_{SC} = \frac{V_{BE2}}{I_{SC}}$$

where,

I_{SC} : Short-circuit current

(3) Negative Regulator

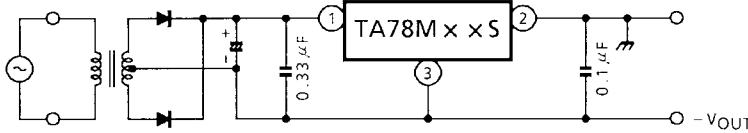

(4) Positive and Negative Regulator

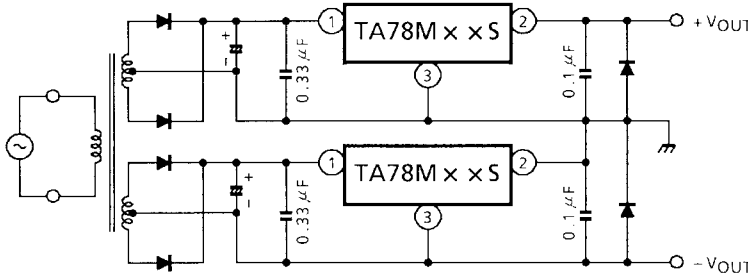

(5) Current Regulator

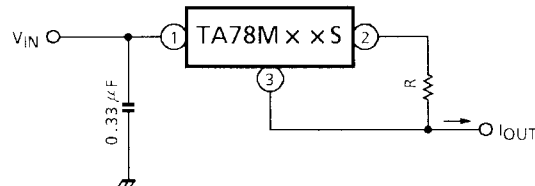

$$I_{OUT} = \frac{V_{OUT}}{R} + I_B$$

Package Dimensions

HSIP3-P-2.54A

Unit: mm

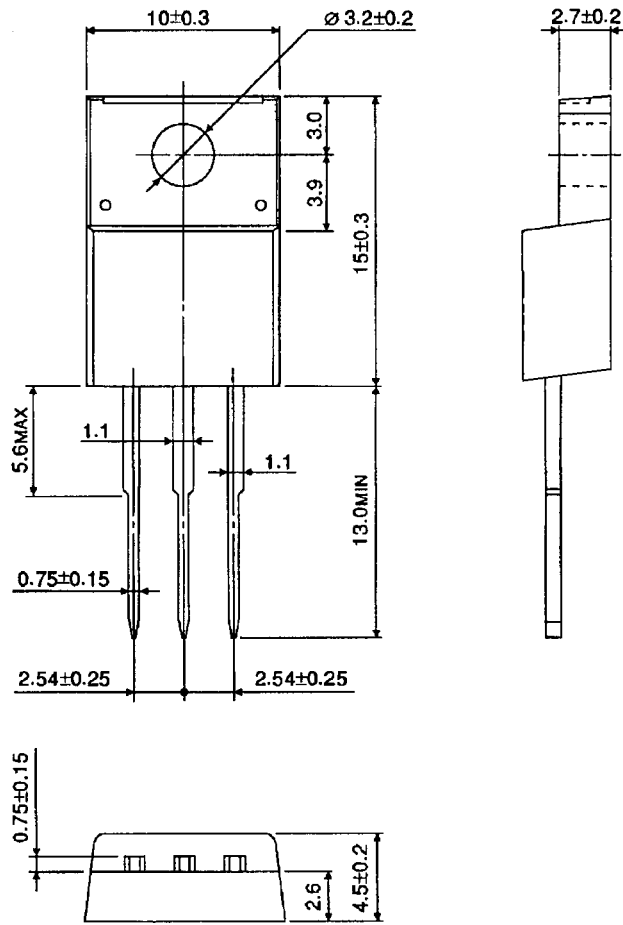

Weight: 1.7 g (typ.)

RESTRICTIONS ON PRODUCT USE

000707EBA

- TOSHIBA is continually working to improve the quality and reliability of its products. Nevertheless, semiconductor devices in general can malfunction or fail due to their inherent electrical sensitivity and vulnerability to physical stress. It is the responsibility of the buyer, when utilizing TOSHIBA products, to comply with the standards of safety in making a safe design for the entire system, and to avoid situations in which a malfunction or failure of such TOSHIBA products could cause loss of human life, bodily injury or damage to property.
In developing your designs, please ensure that TOSHIBA products are used within specified operating ranges as set forth in the most recent TOSHIBA products specifications. Also, please keep in mind the precautions and conditions set forth in the "Handling Guide for Semiconductor Devices," or "TOSHIBA Semiconductor Reliability Handbook" etc..
- The TOSHIBA products listed in this document are intended for usage in general electronics applications (computer, personal equipment, office equipment, measuring equipment, industrial robotics, domestic appliances, etc.). These TOSHIBA products are neither intended nor warranted for usage in equipment that requires extraordinarily high quality and/or reliability or a malfunction or failure of which may cause loss of human life or bodily injury ("Unintended Usage"). Unintended Usage include atomic energy control instruments, airplane or spaceship instruments, transportation instruments, traffic signal instruments, combustion control instruments, medical instruments, all types of safety devices, etc.. Unintended Usage of TOSHIBA products listed in this document shall be made at the customer's own risk.
- The products described in this document are subject to the foreign exchange and foreign trade laws.
- The information contained herein is presented only as a guide for the applications of our products. No responsibility is assumed by TOSHIBA CORPORATION for any infringements of intellectual property or other rights of the third parties which may result from its use. No license is granted by implication or otherwise under any intellectual property or other rights of TOSHIBA CORPORATION or others.
- The information contained herein is subject to change without notice.