

TOSHIBA BIPOLAR LINEAR INTEGRATED CIRCUIT MULTI-CHIP

TA8461F

DUAL POWER OPERATIONAL AMPLIFIER

The TA8461F is a multiple chip IC consisting of 4 saturated voltage discrete transistors and 1 dual operational amplifier.

FEATURES

- Large Output Current : $I_{OUT} = 1.5A$ (MAX.)
- Sealed in a Small Package : SSOP24

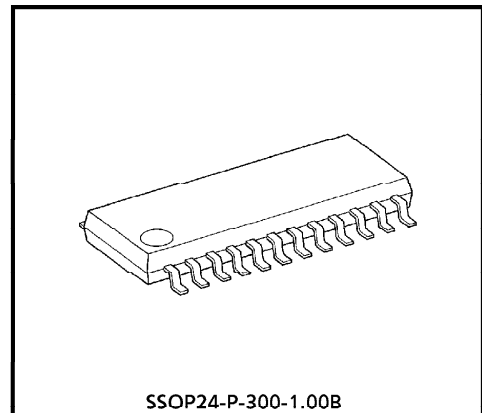

Weight : 0.27g (Typ.)

BLOCK DIAGRAM

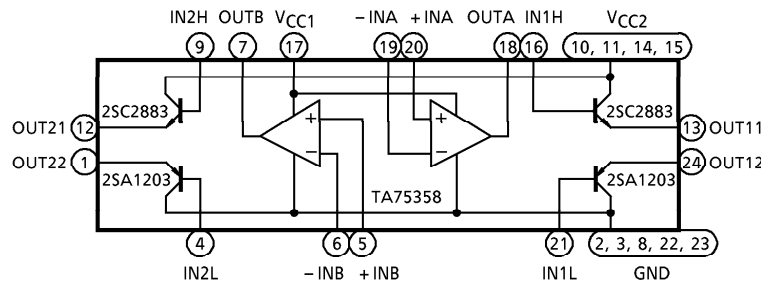

PIN CONNECTION

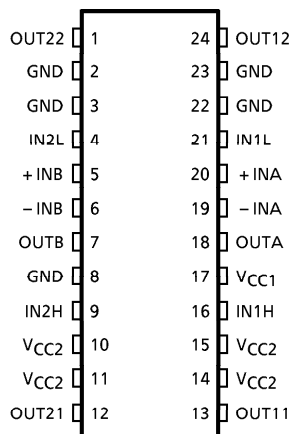

961001EBA2

- TOSHIBA is continually working to improve the quality and the reliability of its products. Nevertheless, semiconductor devices in general can malfunction or fail due to their inherent electrical sensitivity and vulnerability to physical stress. It is the responsibility of the buyer, when utilizing TOSHIBA products, to observe standards of safety, and to avoid situations in which a malfunction or failure of a TOSHIBA product could cause loss of human life, bodily injury or damage to property. In developing your designs, please ensure that TOSHIBA products are used within specified operating ranges as set forth in the most recent products specifications. Also, please keep in mind the precautions and conditions set forth in the TOSHIBA Semiconductor Reliability Handbook.
- The products described in this document are subject to foreign exchange and foreign trade control laws.
- The information contained herein is presented only as a guide for the applications of our products. No responsibility is assumed by TOSHIBA CORPORATION for any infringements of intellectual property or other rights of the third parties which may result from its use. No license is granted by implication or otherwise under any intellectual property or other rights of TOSHIBA CORPORATION or others.
- The information contained herein is subject to change without notice.

PIN FUNCTION

PIN No.	SYMBOL	FUNCTIONAL DESCRIPTION
1	OUT22	PNP (2) Emitter
2	GND	GND
3	GND	GND
4	IN2L	PNP (2) Base
5	+ INB	OP. Amp (B) input (+)
6	- INB	OP. Amp (B) input (-)
7	OUTB	OP. Amp (B) output
8	GND	GND
9	IN2H	NPN (2) Base
10	V _{CC2}	Output transistor voltage supply
11	V _{CC2}	Output transistor voltage supply
12	OUT21	NPN (2) Emitter
13	OUT11	NPN (1) Emitter
14	V _{CC2}	Output transistor voltage supply
15	V _{CC2}	Output transistor voltage supply
16	IN1H	NPN (1) Base
17	V _{CC1}	OP. Amp. voltage supply
18	OUTA	OP. Amp. (A) output
19	- INA	OP. Amp. (A) input (-)
20	+ INA	OP. Amp. (A) input (+)
21	IN1L	PNP (1) Base
22	GND	GND
23	GND	GND
24	OUT12	PNP (1) Emitter

MAXIMUM RATINGS (Ta = 25°C)

CHARACTERISTIC		SYMBOL	RATING	UNIT	
Supply Voltage		V _{CC}	30	V	
Output Transistor	Collector-Base Voltage	V _{CB0}	30	V	
	Collector-Emitter Voltage	V _{CEO}	30	V	
	Emitter-Base Voltage	V _{EBO}	5	V	
	Output Current	I _{OUT (AVE.)}	1.5	(Note 1) 3.0	A
		I _{OUT (PEAK)}			
	Base Current	I _B	0.3	A	
OP. Amp.	Amplifier Differential Input Voltage	DV _{IN}	30	V	
	Amplifier Input Voltage	V _{IN}	30	V	
Power Dissipation		P _D	(Note 2) 1.0	W	
Junction Temperature		T _j	125	°C	
Operating Temperature		T _{opr}	- 40~85	°C	
Storage Temperature		T _{stg}	- 55~125	°C	

(Note 1) Pulse measured : Pulse width = 10ms (MAX.)
 Repetition cycle = 30% (MAX.)

(Note 2) No heat sink

ELECTRICAL CHARACTERISTICS

Output transistor unit (Ta = 25°C)

CHARACTERISTIC	SYMBOL	TEST CIRCUIT	TEST CONDITION	MIN.	TYP.	MAX.	UNIT
DC Current Amplification Factor	h _{FE} (1)	—	V _{CE} = 2V, I _C = 0.5A	160	—	600	
	h _{FE} (2)	—	V _{CE} = 2V, I _C = 1.5A	50	100	—	
Output Saturation Voltage	V _{CE} (sat) (NPN)	—	I _C = 0.5A, I _B = 10mA	—	0.2	0.50	V
			I _C = 1.5A, I _B = 30mA	—	—	2.0	
	V _{CE} (sat) (PNP)	—	I _C = 0.5A, I _B = 10mA	—	0.2	0.50	
			I _C = 1.5A, I _B = 30mA	—	—	2.0	
Transition Frequency	f _T	—	V _{CE} = 2V, I _C = 0.5A	—	120	—	MHz
Output Leakage Current	I _{OL} (NPN)	—	V _{CC} = 30V	—	0	10	μA
	I _{OL} (PNP)	—	V _{CC} = 30V	—	0	10	
Base-Emitter Voltage	V _{BE} (NPN)	—	V _{CE} = 2V, I _C = 0.5A	—	—	1.0	V
	V _{BE} (PNP)	—	V _{CE} = 2V, I _C = 0.5A	—	—	1.0	

Operational amplifier unit (V_{CC} = 5V, Ta = 25°C)

CHARACTERISTIC	SYMBOL	TEST CIRCUIT	TEST CONDITION	MIN.	TYP.	MAX.	UNIT
Input Offset Voltage	V _{IO}	1	R _g ≤ 10kΩ	—	2	7	mV
Input Offset Current	I _{IO}	2	—	—	5	50	nA
Input Bias Current	I _I	2	—	—	45	250	nA
In-Phase Input Voltage	CMV _{IN}	3	V _{CC} = 30V	0	—	V _{CC} - 1.5	V
Supply Current	I _{CC}	4	R _L = ∞, ALL OP Amps	—	0.7	1.2	mA
Voltage Gain	G _V	5	R _L ≥ 2kΩ	86	100	—	dB
Maximum Output Amplitude Voltage	V _{Op-p}	6	R _L = 2kΩ	0	—	V _{CC} - 1.5	V
Common Mode Rejection Ratio	CMRR	3	—	60	85	—	dB
Supply Voltage Rejection Ratio	SVRR	1	R _g ≤ 10kΩ	60	100	—	dB
Source Current	I _{source}	6	IN (-) = 0V _{DC} , IN (+) = 1V _{DC}	20	40	—	mA
Sink Current	I _{sink}	6	IN (-) = 0V _{DC} , IN (+) = 1V _{DC}	10	20	—	mA
Cut-off Frequency	f _T	—	—	—	1.5	—	MHz
Slew Rate	S _R	—	—	—	0.8	—	V / μs

TEST CIRCUIT

(1) V_{IO} , SVRR

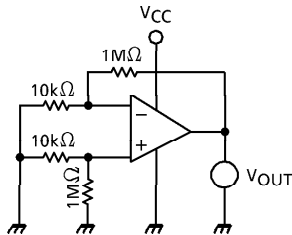

- $V_{IO} = V_{OUT} / 100$
- $SVRR = 20 \log E$ (dB)

$$E = \left| \frac{V_{OUT1} - V_{OUT2}}{V_{CC1} - V_{CC2}} \right| \times \frac{1}{100}$$

V_{OUT1} : V_{OUT} ($V_{CC1} = 5V$)
 V_{OUT2} : V_{OUT} ($V_{CC2} = 10V$)

(2) I_I , I_{IO}

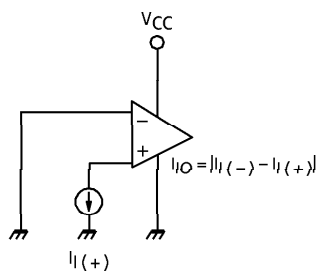
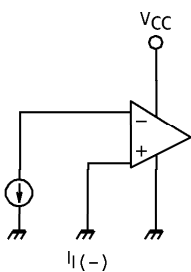

(3) CMV_{IN} , CMRR

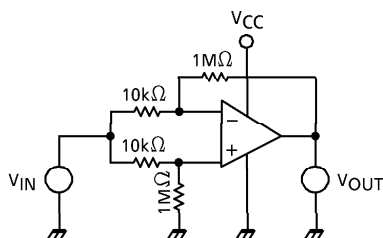

- $CMRR = 20 \log G_D / G_C$ (dB)
 G_D : Differential Voltage Gain
 G_C : In-phase Voltage Gain
- CMV_{IN} : $V_{IN} = 0V$, $V_{CC} = 1.5V$

(4) I_{CC}

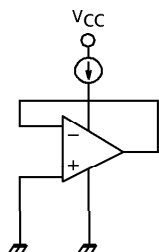

- I_{CC} : $V_{CC} = 5V$

(5) G_V

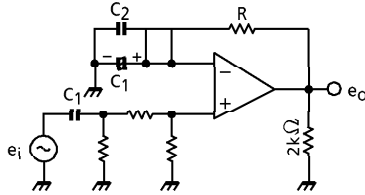

- $G_V = 20 \log e_o / e_i$ (dB)
- $R \gg 1 / \omega C_1$
- C_1 : For Preventing DC Short-Circuit.
- C_2 : For High Frequency Short-Circuit.
- Use a Mica or Titanium Capacitor.

(6) V_{Op-p} , I_{source} , I_{sink}

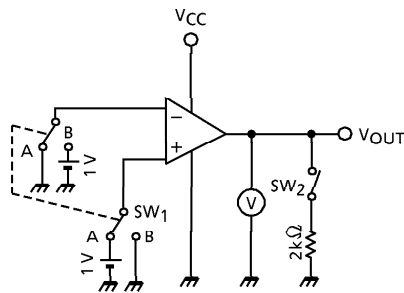

- V_{Op-p}
 - V_{OH} : SW₁ is to A side.
 - V_{OL} : SW₁ is to B side.
- I_{source}
 - SW₁ is to A side.
 - $V_{OUT} \rightarrow 0V$ Measurement
- I_{sink}
 - SW₁ is to B side.
 - $V_{OUT} \rightarrow 5V$ Measurement

CHARACTERISTIC CURVES ($T_a = 25^\circ\text{C}$)
 (1) Operational amplifier

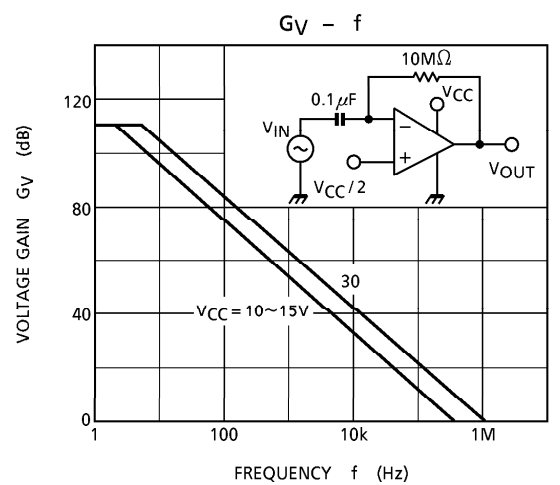
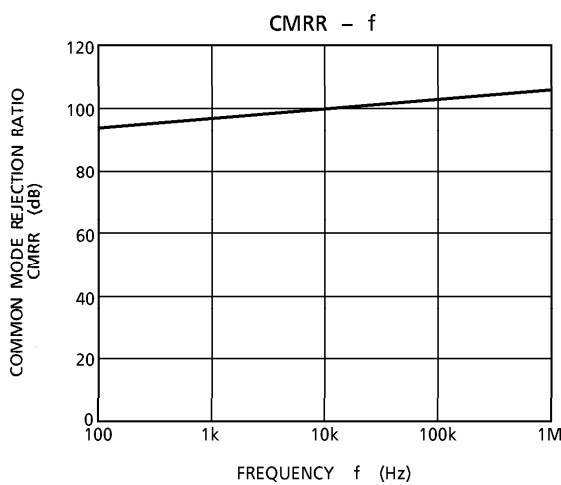
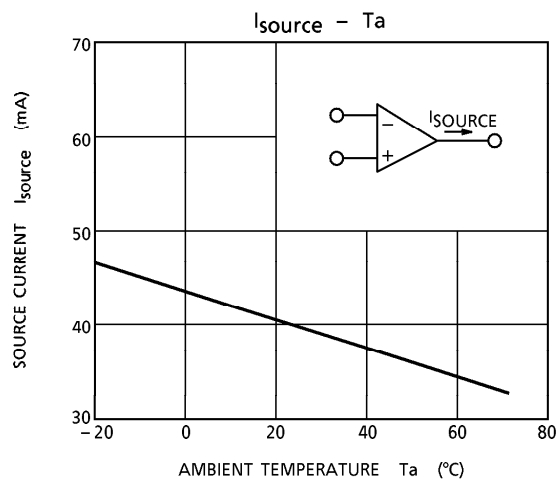
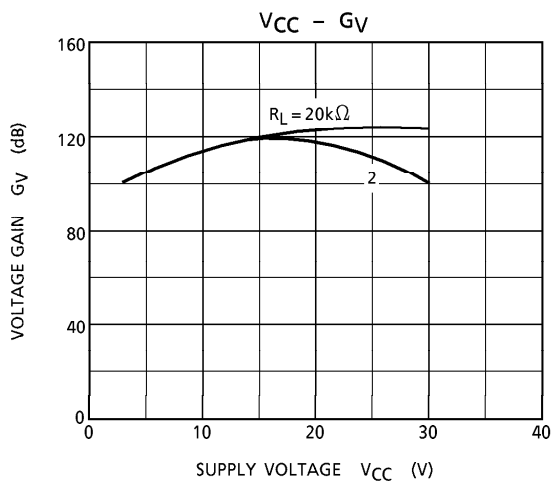
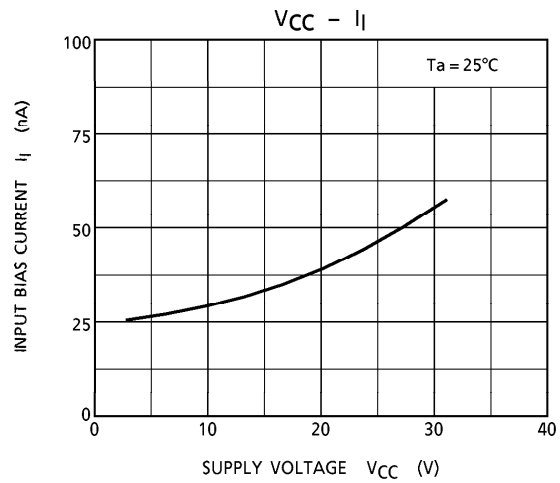
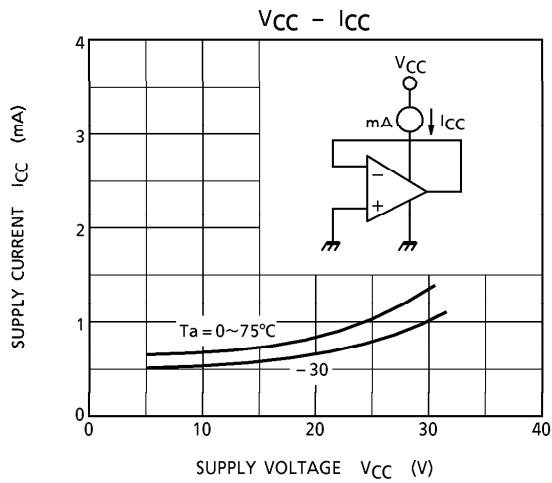

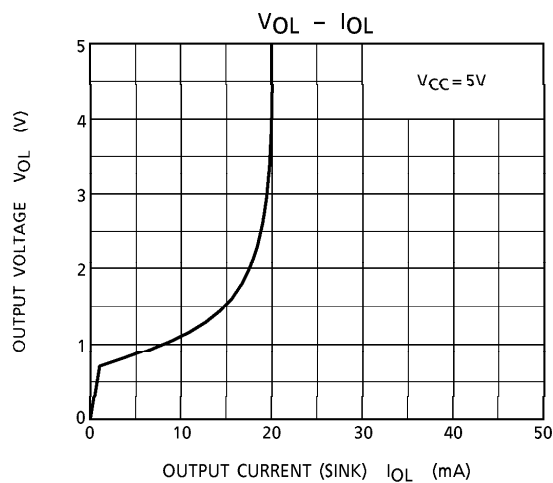
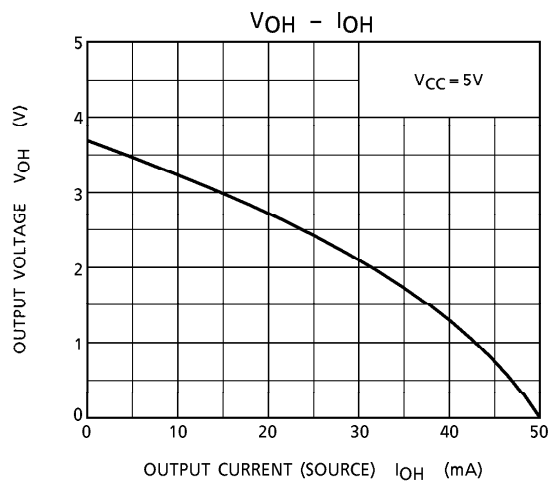
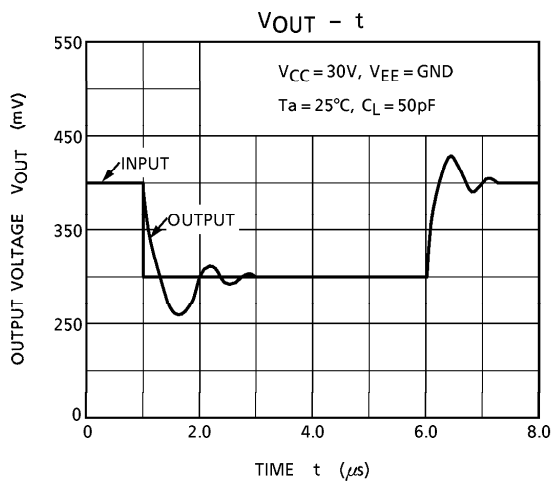
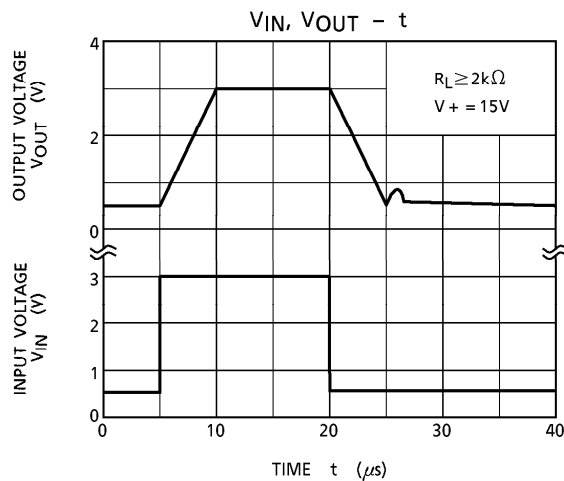
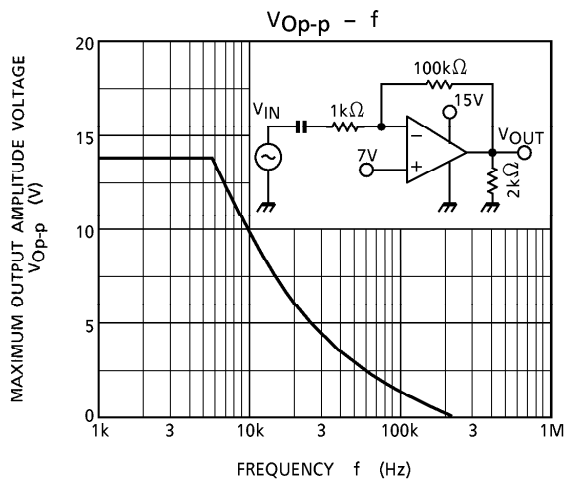

(2) NPN transistor, PNP transistor

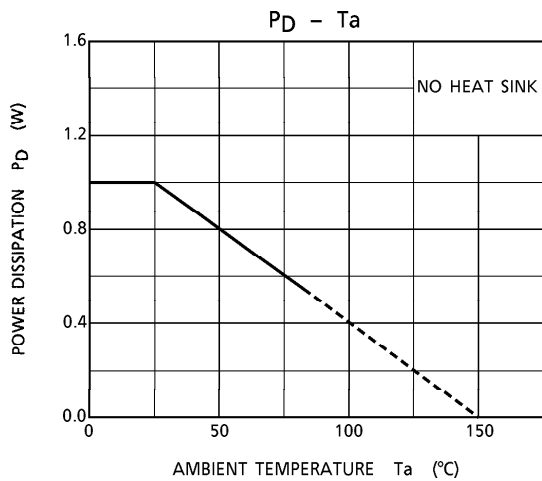
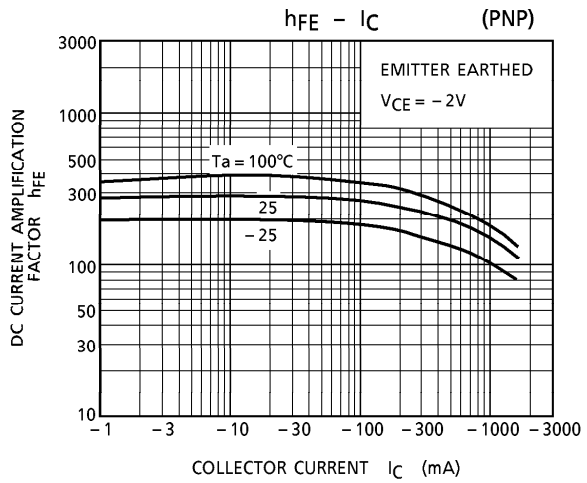
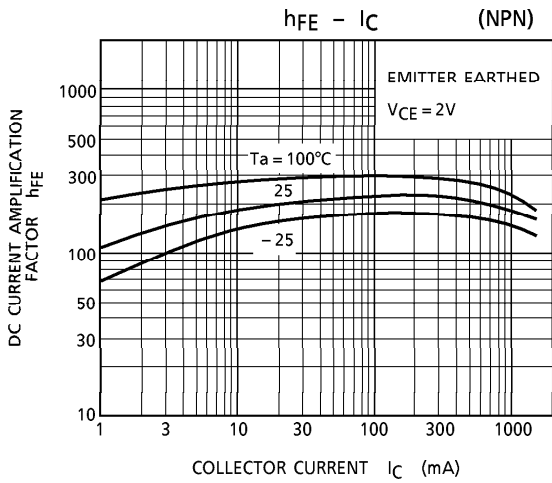
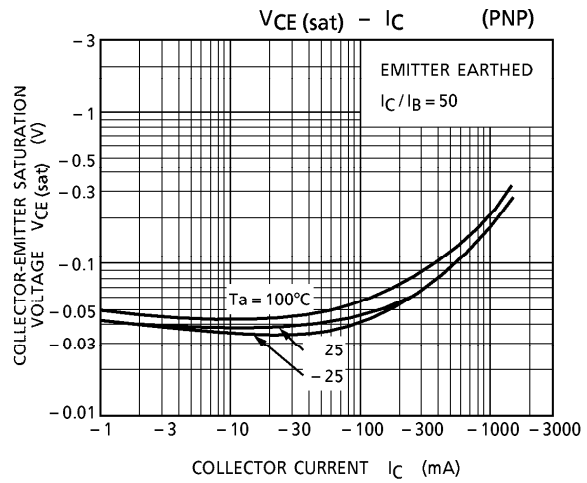
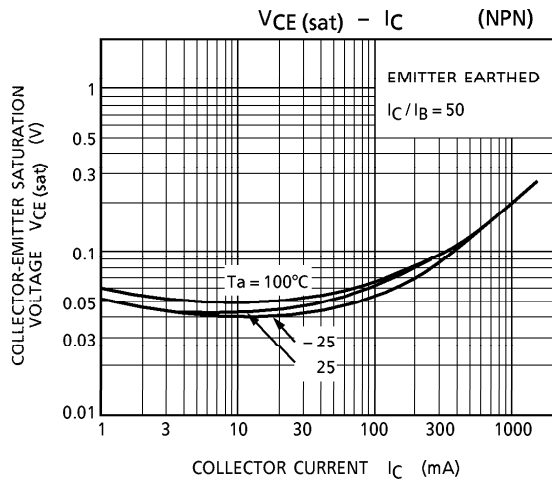

OUTLINE DRAWING
SSOP24-P-300-1.00B

Unit : mm

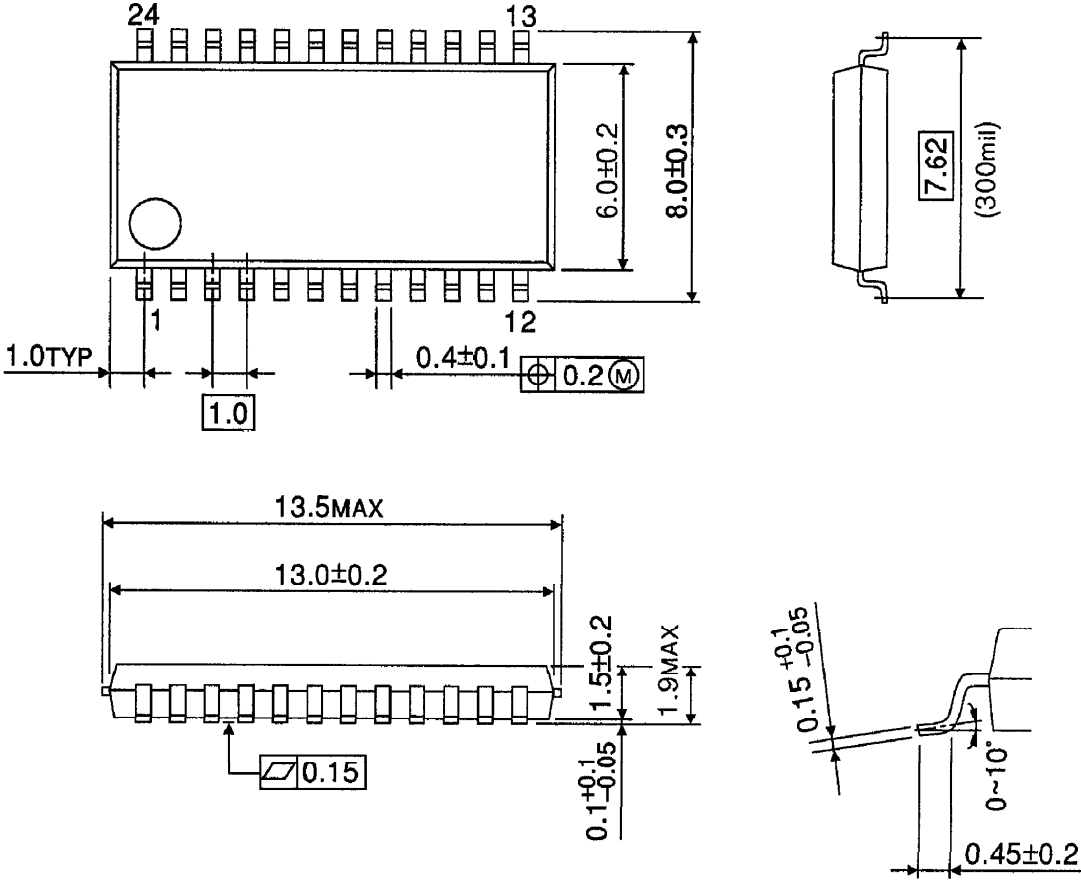

Weight : 0.27g (Typ.)