

TC4017BP, TC4017BF

TC4017BP / TC4017BF DECADE COUNTER / DIVIDER

TC4017BP / BF is decimal Johnson counter consisting of 5 stage D-type flip-flop equipped with the decoder to convert the output to decimal.

Depending on the number of count pulses fed to CLOCK or CLOCK INHIBIT one output among 10 output lines "Q0" through "Q9" becomes "H" level.

The counter advances its state at rising edge of CLOCK (CLOCK INHIBIT="L") or falling edge of CLOCK INHIBIT (CLOCK="H"). RESET input to "H" level resets the counter to Q0="H" and Q1 through Q9="L" regardless of CLOCK and CLOCK INHIBIT.

MAXIMUM RATINGS

CHARACTERISTIC	SYMBOL	RATING	UNIT
DC Supply Voltage	V_{DD}	$V_{SS} - 0.5 \sim V_{SS} + 20$	V
Input Voltage	V_{IN}	$V_{SS} - 0.5 \sim V_{DD} + 0.5$	V
Output Voltage	V_{OUT}	$V_{SS} - 0.5 \sim V_{DD} + 0.5$	V
DC Input Current	I_{IN}	± 10	mA
Power Dissipation	P_D	300 (DIP) / 180 (SOIC)	mW
Operating Ambient Temperature Range	T_{opr}	-40~85	°C
Storage Temperature Range	T_{stg}	-65~150	°C

LOGIC DIAGRAM

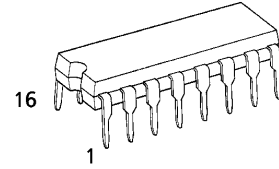
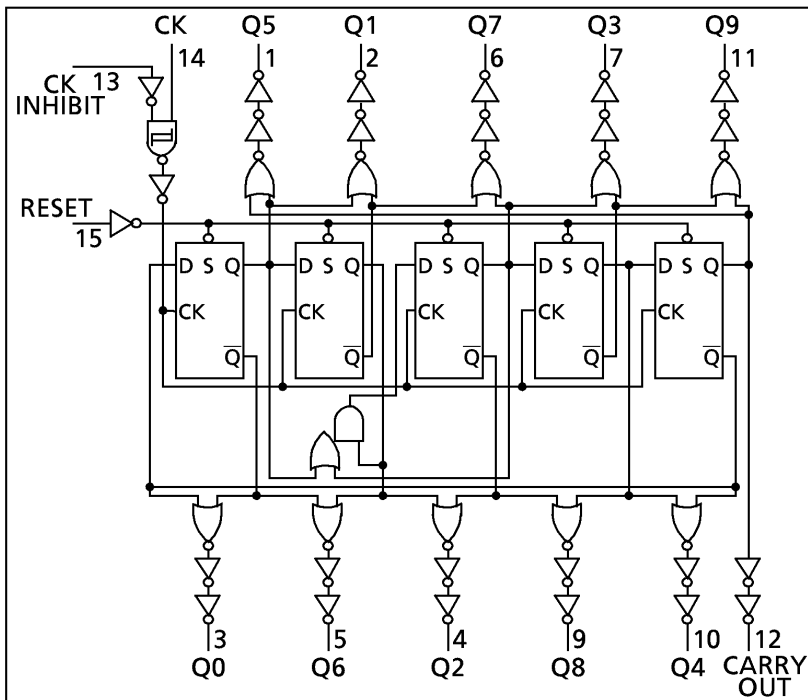

P (DIP16-P-300-2.54A)
Weight : 1.00g (Typ.)

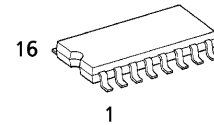

F (SOP16-P-300-1.27)
Weight : 0.18g (Typ.)

PIN ASSIGNMENT

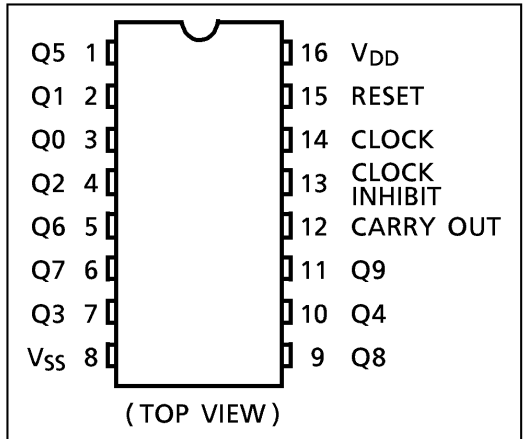

TRUTH TABLE

INPUTS			SELECTED OUTPUT
CLOCK Δ	CLOCK INHIBIT Δ	RESET	
※	※	H	Q0
※	H	L	Qn (NC)
L	※	L	Qn (NC)
\uparrow	L	L	Qn + 1
\downarrow	L	L	Qn (NC)
H	\uparrow	L	Qn (NC)
H	\downarrow	L	Qn + 1

Δ ; Level Change
 ※ ; Don't Care
 NC ; No Change
 CARRY OUT { "H" Q0 ~ Q4 = "H"
 "L" Q5 ~ Q9 = "H"

TIMING CHART

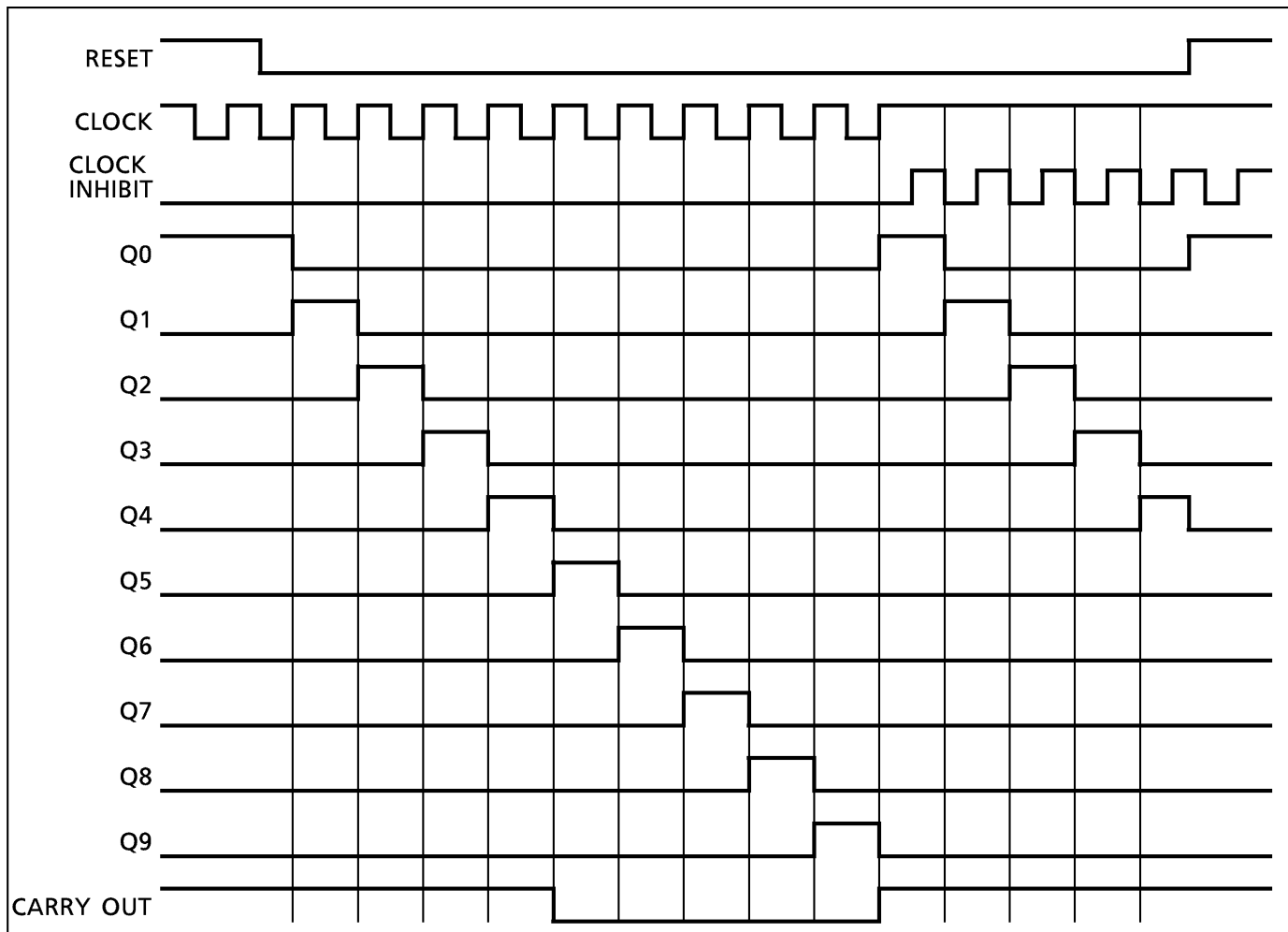

RECOMMENDED OPERATING CONDITIONS ($V_{SS} = 0V$)

CHARACTERISTIC	SYMBOL	TEST CONDITION	MIN.	TYP.	MAX.	UNIT
DC Supply Voltage	V_{DD}		3	—	18	V
Input Voltage	V_{IN}		0	—	V_{DD}	V

STATIC ELECTRICAL CHARACTERISTICS ($V_{SS} = 0V$)

CHARACTERISTIC	SYM-BOL	TEST CONDITION	V_{DD} (V)	-40°C		25°C			85°C		UNIT
				MIN.	MAX.	MIN.	MIN.	MAX.	MIN.	MAX.	
High-Level Output Voltage	V_{OH}	$ I_{OUT} < 1\mu A$ $V_{IN} = V_{SS}, V_{DD}$	5	4.95	—	4.95	5.00	—	4.95	—	V
			10	9.95	—	9.95	10.00	—	9.95	—	
			15	14.95	—	14.95	15.00	—	14.95	—	
Low-Level Output Voltage	V_{OL}	$ I_{OUT} < 1\mu A$ $V_{IN} = V_{SS}, V_{DD}$	5	—	0.05	—	0.00	0.05	—	0.05	V
			10	—	0.05	—	0.00	0.05	—	0.05	
			15	—	0.05	—	0.00	0.05	—	0.05	

STATIC ELECTRICAL CHARACTERISTICS ($V_{SS} = 0V$)

CHARACTERISTIC	SYM-BOL	TEST CONDITION	V_{DD} (V)	- 40°C		25°C			85°C		UNIT	
				MIN.	MAX.	MIN.	MIN.	MAX.	MIN.	MAX.		
Output High Current	I_{OH}	$V_{OH} = 4.6V$	5	-0.61	—	-0.51	-1.0	—	-0.42	—	mA	
		$V_{OH} = 2.5V$	5	-2.50	—	-2.10	-4.0	—	-1.70	—		
		$V_{OH} = 9.5V$	10	-1.50	—	-1.30	-2.2	—	-1.10	—		
		$V_{OH} = 13.5V$	15	-4.00	—	-3.40	-9.0	—	-2.80	—		
		$V_{IN} = V_{SS}, V_{DD}$										
Output Low Current	I_{OL}	$V_{OL} = 0.4V$	5	0.61	—	0.51	1.5	—	0.42	—	mA	
		$V_{OL} = 0.5V$	10	1.50	—	1.30	3.8	—	1.10	—		
		$V_{OL} = 1.5V$	15	4.00	—	3.40	15.0	—	2.80	—		
		$V_{IN} = V_{SS}, V_{DD}$										
Input High Voltage	V_{IH}	$V_{OUT} = 0.5V, 4.5V$	5	3.5	—	3.5	2.75	—	3.5	—	V	
		$V_{OUT} = 1.0V, 9.0V$	10	7.0	—	7.0	5.50	—	7.0	—		
		$V_{OUT} = 1.5V, 13.5V$	15	11.0	—	11.0	8.25	—	11.0	—		
		$ I_{OUT} < 1\mu A$										
Input Low Voltage	V_{IL}	$V_{OUT} = 0.5V, 4.5V$	5	—	1.5	—	2.25	1.5	—	1.5	V	
		$V_{OUT} = 1.0V, 9.0V$	10	—	3.0	—	4.50	3.0	—	3.0		
		$V_{OUT} = 1.5V, 13.5V$	15	—	4.0	—	6.75	4.0	—	4.0		
		$ I_{OUT} < 1\mu A$										
Input Current	"H" Level	I_{IH}	$V_{IH} = 18V$	18	—	0.1	—	10^{-5}	0.1	—	1.0	μA
	"L" Level	I_{IL}	$V_{IL} = 0V$	18	—	-0.1	—	-10^{-5}	-0.1	—	-1.0	
Quiescent Supply Current	I_{DD}	$V_{IN} = V_{SS}, V_{DD} *$	5	—	5	—	0.005	5	—	150	μA	
			10	—	10	—	0.010	10	—	300		
			15	—	15	—	0.015	20	—	600		

* All valid input combinations.

DYNAMIC ELECTRICAL CHARACTERISTICS ($T_a = 25^\circ C, V_{SS} = 0V, C_L = 50pF$)

CHARACTERISTIC	SYMBOL	TEST CONDITION	V_{DD} (V)	MIN.	TYP.	MAX.	UNIT
Output Transition Time (Low to High)	t_{TLH}		5	—	80	200	ns
			10	—	50	100	
			15	—	40	80	
Output Transition Time (High to Low)	t_{THL}		5	—	80	200	ns
			10	—	50	100	
			15	—	40	80	

DYNAMIC ELECTRICAL CHARACTERISTICS (Ta = 25°C, Vss = 0V, CL = 50pF)

CHARACTERISTIC	SYMBOL	TEST CONDITION	V _{DD} (V)	MIN.	TYP.	MAX.	UNIT	
Propagation Delay Time (CLOCK - Qn)	t _{pLH} t _{pHL}		5	—	325	650	ns	
			10	—	135	270		
			15	—	85	170		
Propagation Delay Time (CLOCK - CARRY OUT)	t _{pLH} t _{pHL}		5	—	280	600		
			10	—	110	250		
			15	—	75	160		
Propagation Delay Time (RESET - Qn RESET - CARRY OUT)	t _{pLH} t _{pHL}		5	—	265	530		
			10	—	115	230		
			15	—	85	170		
Max. Clock Frequency	f _{CL}		5	2.5	6.0	—	MHz	
			10	5.0	12.0	—		
			15	6.7	13.5	—		
Min. Clock Pulse Width	t _w		5	—	85	200	ns	
			10	—	40	90		
			15	—	35	60		
Min. Pulse Width (RESET)	t _{WH}		5	—	50	260		
			10	—	20	110		
			15	—	15	60		
Max. Clock Rise Time Max. Clock Fall Time	t _{rCL} t _{fCL}		5	No Limit				μs
			10					
			15					
Min. Set-up Time (CLOCK INHIBIT - CLOCK)	t _{SU}		5	—	30	230	ns	
			10	—	15	100		
			15	—	10	70		
Min. Removal Time (RESET - CLOCK)	t _{rem}		5	—	-55	400	ns	
			10	—	-20	275		
			15	—	-15	150		
Input Capacitance	C _{IN}			—	5	7.5	pF	

WAVEFORMS FOR MEASUREMENT OF DYNAMIC CHARACTERISTICS

WAVEFORM 1.

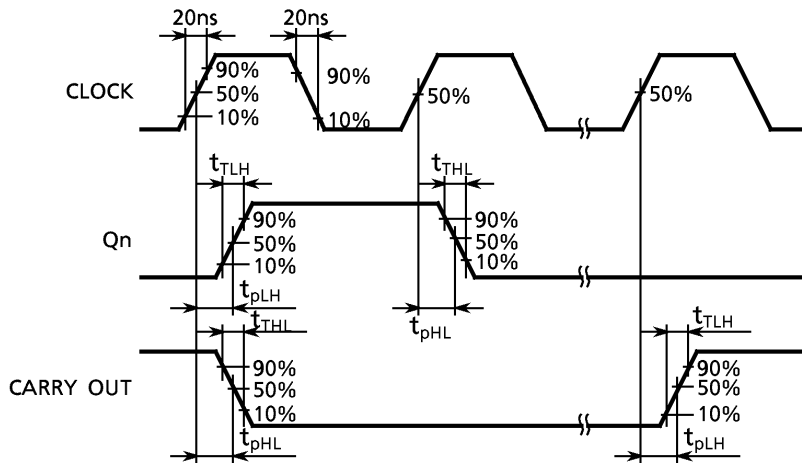

WAVEFORM 2.

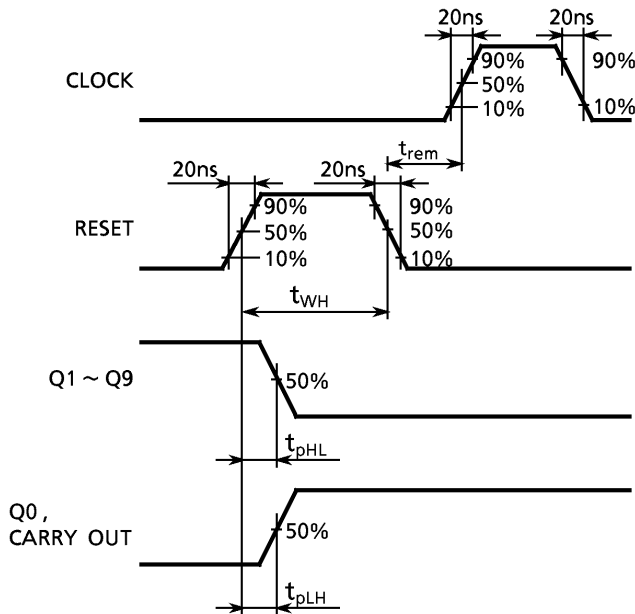

WAVEFORM 3.

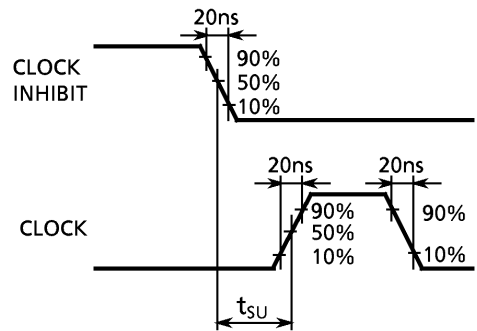

DIP 16PIN PACKAGE DIMENSIONS (DIP16-P-300-2.54A)

Unit in mm

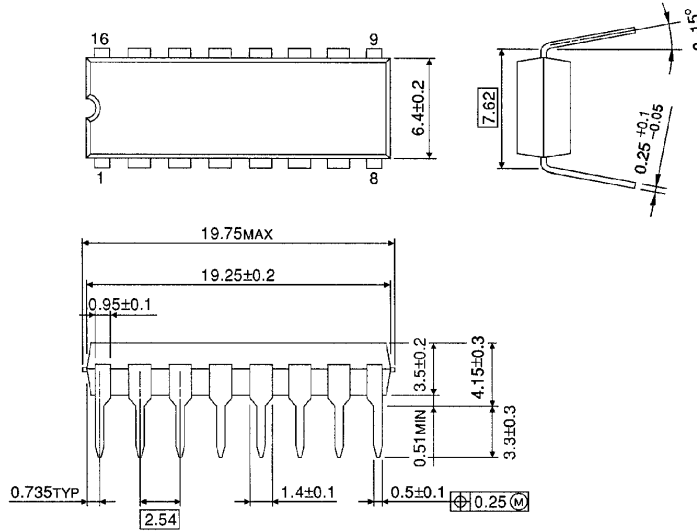

Weight : 1.00g (Typ.)

SOP 16PIN (200mil BODY) PACKAGE DIMENSIONS (SOP16-P-300-1.27)

Unit in mm

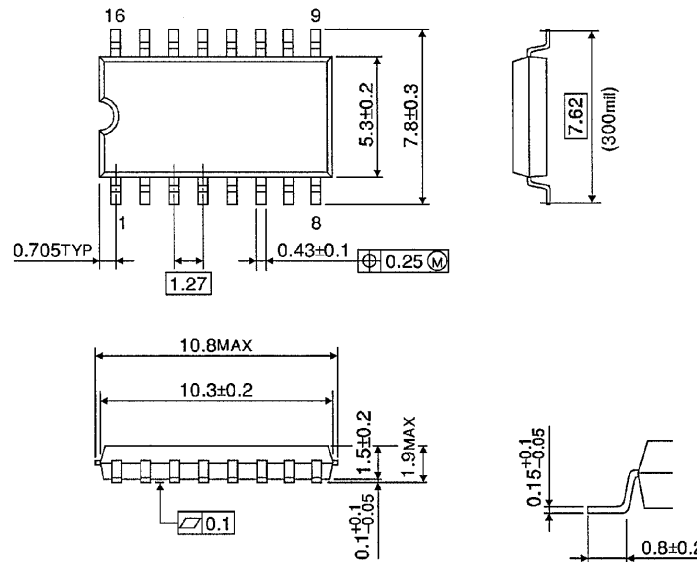

Weight : 0.18g (Typ.)

RESTRICTIONS ON PRODUCT USE

000707EBA

- TOSHIBA is continually working to improve the quality and reliability of its products. Nevertheless, semiconductor devices in general can malfunction or fail due to their inherent electrical sensitivity and vulnerability to physical stress. It is the responsibility of the buyer, when utilizing TOSHIBA products, to comply with the standards of safety in making a safe design for the entire system, and to avoid situations in which a malfunction or failure of such TOSHIBA products could cause loss of human life, bodily injury or damage to property. In developing your designs, please ensure that TOSHIBA products are used within specified operating ranges as set forth in the most recent TOSHIBA products specifications. Also, please keep in mind the precautions and conditions set forth in the "Handling Guide for Semiconductor Devices," or "TOSHIBA Semiconductor Reliability Handbook" etc..
- The TOSHIBA products listed in this document are intended for usage in general electronics applications (computer, personal equipment, office equipment, measuring equipment, industrial robotics, domestic appliances, etc.). These TOSHIBA products are neither intended nor warranted for usage in equipment that requires extraordinarily high quality and/or reliability or a malfunction or failure of which may cause loss of human life or bodily injury ("Unintended Usage"). Unintended Usage include atomic energy control instruments, airplane or spaceship instruments, transportation instruments, traffic signal instruments, combustion control instruments, medical instruments, all types of safety devices, etc.. Unintended Usage of TOSHIBA products listed in this document shall be made at the customer's own risk.
- The products described in this document are subject to the foreign exchange and foreign trade laws.
- The information contained herein is presented only as a guide for the applications of our products. No responsibility is assumed by TOSHIBA CORPORATION for any infringements of intellectual property or other rights of the third parties which may result from its use. No license is granted by implication or otherwise under any intellectual property or other rights of TOSHIBA CORPORATION or others.
- The information contained herein is subject to change without notice.