

TOSHIBA CMOS Digital Integrated Circuit Silicon Monolithic

TC7MA138FK

Low Voltage 3-to-8 Line Decoder with 3.6 V Tolerant Inputs and Outputs

The TC7MA138FK is a high performance CMOS 3-to-8 decoder which is guaranteed to operate from 1.2-V to 3.6-V. Designed for use in 1.5 V, 1.8 V, 2.5 V or 3.3 V systems, it achieves high speed operation while maintaining the CMOS low power dissipation.

It is also designed with over voltage tolerant inputs and outputs up to 3.6 V.

When the device is enabled, 3 binary select inputs (A, B and C) determine which one of the outputs ($\overline{Y0}$ - $\overline{Y7}$) will go low.

When enable input G1 is held low or either $\overline{G2A}$ or $\overline{G2B}$ is held high, decoding function is inhibited and all outputs go high.

G1, $\overline{G2A}$ and $\overline{G2B}$ inputs are provided to ease cascade connection and for use as an address decoder for memory systems.

All inputs are equipped with protection circuits against static discharge.

Features

- Low voltage operation: $V_{CC} = 1.2\sim 3.6$ V
- High speed operation: $t_{pd} = 3.5$ ns (max) ($V_{CC} = 3.0\sim 3.6$ V)
 $t_{pd} = 4.1$ ns (max) ($V_{CC} = 2.3\sim 2.7$ V)
 $t_{pd} = 8.2$ ns (max) ($V_{CC} = 1.65\sim 1.95$ V)
 $t_{pd} = 16.4$ ns (max) ($V_{CC} = 1.4\sim 1.6$ V)
 $t_{pd} = 41.0$ ns (max) ($V_{CC} = 1.2$ V)
- 3.6 V tolerant inputs and outputs.
- Output current: $I_{OH}/I_{OL} = \pm 24$ mA (min) ($V_{CC} = 3.0$ V)
 $I_{OH}/I_{OL} = \pm 18$ mA (min) ($V_{CC} = 2.3$ V)
 $I_{OH}/I_{OL} = \pm 6$ mA (min) ($V_{CC} = 1.65$ V)
 $I_{OH}/I_{OL} = \pm 2$ mA (min) ($V_{CC} = 1.4$ V)
- Latch-up performance: ± 300 mA
- ESD performance: Machine model $> \pm 200$ V
Human body model $> \pm 2000$ V
- Package: VSSOP (US16)
- Power down protection is provided on all inputs and outputs.

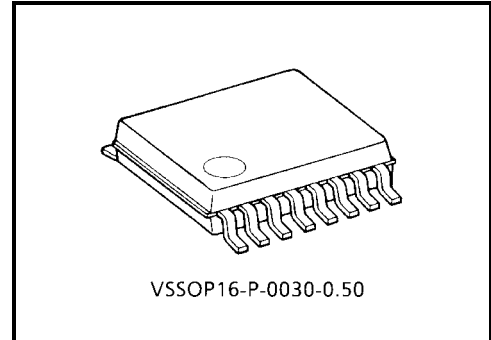

Weight: 0.02 g (typ.)

Pin Assignment (top view)

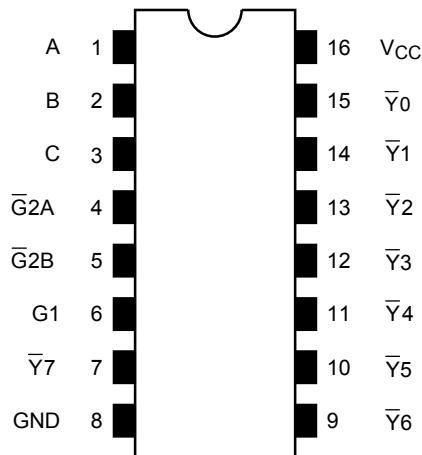

IEC Logic Symbol

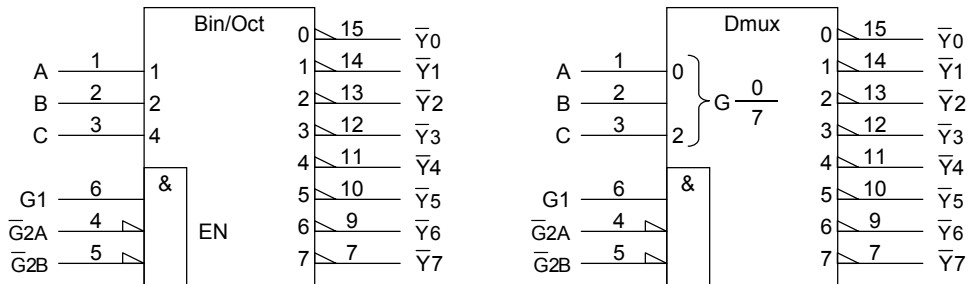

Truth Table

Inputs						Outputs								Selected Output
Enable			Select			$\bar{Y}0$	$\bar{Y}1$	$\bar{Y}2$	$\bar{Y}3$	$\bar{Y}4$	$\bar{Y}5$	$\bar{Y}6$	$\bar{Y}7$	
G1	$\bar{G}2A$	$\bar{G}2B$	C	B	A									
L	X	X	X	X	X	H	H	H	H	H	H	H	H	None
X	H	X	X	X	X	H	H	H	H	H	H	H	H	None
X	X	H	X	X	X	H	H	H	H	H	H	H	H	None
H	L	L	L	L	L	L	H	H	H	H	H	H	H	$\bar{Y}0$
H	L	L	L	L	H	H	L	H	H	H	H	H	H	$\bar{Y}1$
H	L	L	L	H	L	H	H	L	H	H	H	H	H	$\bar{Y}2$
H	L	L	L	H	H	H	H	H	L	H	H	H	H	$\bar{Y}3$
H	L	L	H	L	L	H	H	H	H	L	H	H	H	$\bar{Y}4$
H	L	L	H	L	H	H	H	H	H	H	L	H	H	$\bar{Y}5$
H	L	L	H	H	L	H	H	H	H	H	H	L	H	$\bar{Y}6$
H	L	L	H	H	H	H	H	H	H	H	H	H	L	$\bar{Y}7$

X: Don't care

System Diagram

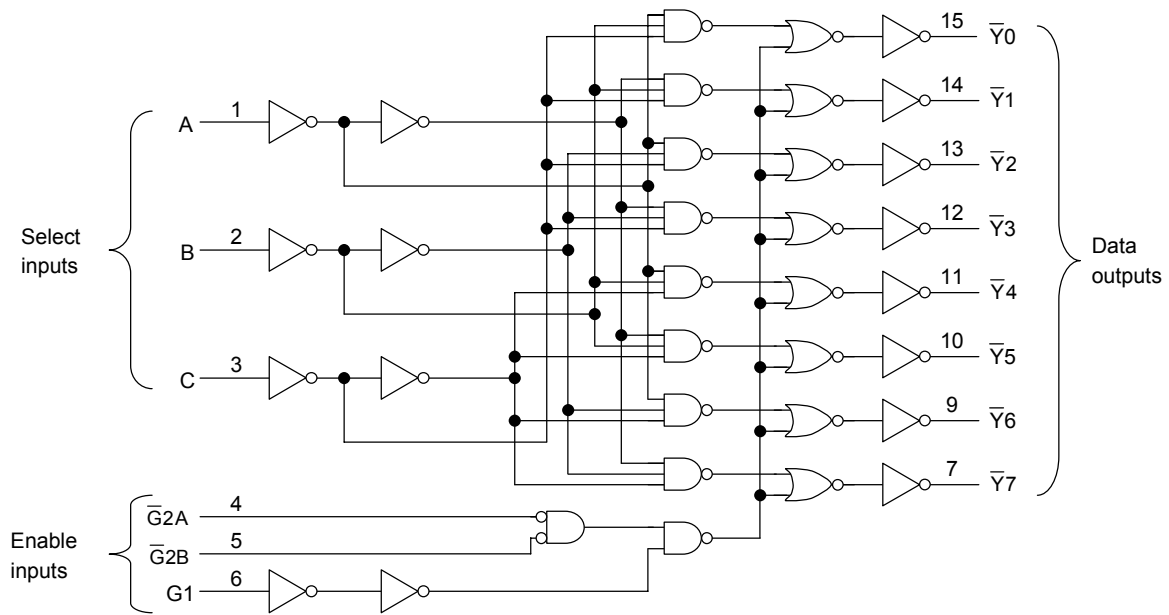

Maximum Ratings

Characteristics	Symbol	Rating	Unit
Power supply voltage	V_{CC}	-0.5~4.6	V
DC input voltage	V_{IN}	-0.5~4.6	V
DC output voltage	V_{OUT}	-0.5~4.6 (Note1)	V
		-0.5~ $V_{CC} + 0.5$ (Note2)	
Input diode current	I_{IK}	-50	mA
Output diode current	I_{OK}	±50 (Note3)	mA
DC output current	I_{OUT}	±50	mA
Power dissipation	P_D	180	mW
DC V_{CC} /ground current	I_{CC}/I_{GND}	±100	mA
Storage temperature	T_{stg}	-65~150	°C

Note 1: $V_{CC} = 0$ V

Note 2: High or low state. I_{OUT} absolute maximum rating must be observed.

Note 3: $V_{OUT} < GND, V_{OUT} > V_{CC}$

Recommended Operating Range

Characteristics	Symbol	Rating	Unit
Supply voltage	V_{CC}	1.2~3.6	V
Input voltage	V_{IN}	-0.3~3.6	V
Output voltage	V_{OUT}	0~3.6 (Note4)	V
		0~ V_{CC} (Note5)	
Output current	I_{OH}/I_{OL}	± 24 (Note6)	mA
		± 18 (Note7)	
		± 6 (Note8)	
		± 2 (Note9)	
Operating temperature	T_{opr}	-40~85	°C
Input rise and fall time	dt/dv	0~10 (Note10)	ns/V

Note 4: $V_{CC} = 0$ V

Note 5: High or low state

Note 6: $V_{CC} = 3.0\sim 3.6$ V

Note 7: $V_{CC} = 2.3\sim 2.7$ V

Note 8: $V_{CC} = 1.65\sim 1.95$ V

Note 9: $V_{CC} = 1.4\sim 1.6$ V

Note 10: $V_{IN} = 0.8\sim 2.0$ V, $V_{CC} = 3.0$ V

Electrical Characteristics

DC Characteristics ($T_a = -40\sim 85^\circ\text{C}$, $2.7\text{ V} < V_{CC} \leq 3.6\text{ V}$)

Characteristics		Symbol	Test Condition	V_{CC} (V)	Min	Max	Unit	
Input voltage	High level	V_{IH}	—	2.7~3.6	2.0	—	V	
	Low level	V_{IL}	—	2.7~3.6	—	0.8		
Output voltage	High level	V_{OH}	$V_{IN} = V_{IH}$ or V_{IL}	$I_{OH} = -100\ \mu\text{A}$	2.7~3.6	$V_{CC} - 0.2$	—	V
				$I_{OH} = -12\ \text{mA}$	2.7	2.2	—	
				$I_{OH} = -18\ \text{mA}$	3.0	2.4	—	
				$I_{OH} = -24\ \text{mA}$	3.0	2.2	—	
	Low level	V_{OL}	$V_{IN} = V_{IH}$ or V_{IL}	$I_{OL} = 100\ \mu\text{A}$	2.7~3.6	—	0.2	
				$I_{OL} = 12\ \text{mA}$	2.7	—	0.4	
				$I_{OL} = 18\ \text{mA}$	3.0	—	0.4	
				$I_{OL} = 24\ \text{mA}$	3.0	—	0.55	
Input leakage current		I_{IN}	$V_{IN} = 0\sim 3.6\text{ V}$	2.7~3.6	—	± 5.0	μA	
Power off leakage current		I_{OFF}	$V_{IN}, V_{OUT} = 0\sim 3.6\text{ V}$	0	—	10.0	μA	
Quiescent supply current		I_{CC}	$V_{IN} = V_{CC}$ or GND	2.7~3.6	—	20.0	μA	
			$V_{CC} \leq V_{IN} \leq 3.6\text{ V}$	2.7~3.6	—	± 20.0		
Increase in I_{CC} per input		ΔI_{CC}	$V_{IH} = V_{CC} - 0.6\text{ V}$	2.7~3.6	—	750		

DC Characteristics (Ta = -40~85°C, 2.3 V ≤ VCC ≤ 2.7 V)

Characteristics		Symbol	Test Condition		VCC (V)	Min	Max	Unit
Input voltage	High level	V _{IH}	—		2.3~2.7	1.6	—	V
	Low level	V _{IL}	—		2.3~2.7	—	0.7	
Output voltage	High level	V _{OH}	V _{IN} = V _{IH} or V _{IL}	I _{OH} = -100 μA	2.3~2.7	V _{CC} - 0.2	—	V
				I _{OH} = -6 mA	2.3	2.0	—	
				I _{OH} = -12 mA	2.3	1.8	—	
	Low level	V _{OL}	V _{IN} = V _{IH} or V _{IL}	I _{OL} = 100 μA	2.3~2.7	—	0.2	
				I _{OL} = 12 mA	2.3	—	0.4	
				I _{OL} = 18 mA	2.3	—	0.6	
Input leakage current		I _{IN}	V _{IN} = 0~3.6 V		2.3~2.7	—	±5.0	μA
Power off leakage current		I _{OFF}	V _{IN} , V _{OUT} = 0~3.6 V		0	—	10.0	μA
Quiescent supply current		I _{CC}	V _{IN} = V _{CC} or GND		2.3~2.7	—	20.0	μA
			V _{CC} ≤ V _{IN} ≤ 3.6 V		2.3~2.7	—	±20.0	

DC Characteristics (Ta = -40~85°C, 1.65 V ≤ VCC < 2.3 V)

Characteristics		Symbol	Test Condition		VCC (V)	Min	Max	Unit
Input voltage	High level	V _{IH}	—		1.65~2.3	0.65 × V _{CC}	—	V
	Low level	V _{IL}	—		1.65~2.3	—	0.2 × V _{CC}	
Output voltage	High level	V _{OH}	V _{IN} = V _{IH} or V _{IL}	I _{OH} = -100 μA	1.65~2.3	V _{CC} - 0.2	—	V
				I _{OH} = -6 mA	1.65	1.25	—	
	Low level	V _{OL}	V _{IN} = V _{IH} or V _{IL}	I _{OL} = 100 μA	1.65~2.3	—	0.2	
				I _{OL} = 6 mA	1.65	—	0.3	
Input leakage current		I _{IN}	V _{IN} = 0~3.6 V		1.65	—	±5.0	μA
Power off leakage current		I _{OFF}	V _{IN} , V _{OUT} = 0~3.6 V		0	—	10.0	μA
Quiescent supply current		I _{CC}	V _{IN} = V _{CC} or GND		1.65~2.3	—	20.0	μA
			V _{CC} ≤ V _{IN} ≤ 3.6 V		1.65~2.3	—	±20.0	

DC Characteristics (Ta = -40~85°C, 1.4V ≤ VCC < 1.65V)

Characteristics		Symbol	Test Condition		VCC (V)	Min	Max	Unit
Input voltage	High level	V _{IH}	—		1.4~1.65	0.65 V _{CC}	—	V
	Low level	V _{IL}	—		1.4~1.65	—	0.05 × V _{CC}	
Output voltage	High level	V _{OH}	V _{IN} = V _{IH} or V _{IL}	I _{OH} = -100 μA	1.4~1.65	V _{CC} - 0.2	—	V
				I _{OH} = -2 mA	1.4	1.05	—	
	Low level	V _{OL}	V _{IN} = V _{IH} or V _{IL}	I _{OL} = 100 μA	1.4~1.65	—	0.05	
				I _{OL} = 2 mA	1.4	—	0.3	
Input leakage current		I _{IN}	V _{IN} = 0~3.6 V		1.4~1.65	—	±5.0	μA
Power off leakage current		I _{OFF}	V _{IN} , V _{OUT} = 0~3.6 V		0	—	10.0	μA
Quiescent supply current		I _{CC}	V _{IN} = V _{CC} or GND		1.4~1.65	—	20.0	μA
			V _{CC} ≤ V _{IN} ≤ 3.6 V		1.4~1.65	—	±20.0	

DC Characteristics (Ta = -40~85°C, 1.2 V ≤ VCC < 1.4 V)

Characteristics		Symbol	Test Condition		VCC (V)	Min	Max	Unit
Input voltage	High level	V _{IH}	—		1.2~1.4	0.8 × V _{CC}	—	V
	Low level	V _{IL}	—		1.2~1.4	—	0.05 × V _{CC}	
Output voltage	High level	V _{OH}	V _{IN} = V _{IH} or V _{IL}	I _{OH} = -100 μA	1.2	V _{CC} - 0.1	—	V
	Low level	V _{OL}	V _{IN} = V _{IH} or V _{IL}	I _{OL} = 100 μA	1.2	—	0.05	
Input leakage current		I _{IN}	V _{IN} = 0~3.6 V		1.2	—	±5.0	μA
Power off leakage current		I _{OFF}	V _{IN} , V _{OUT} = 0~3.6 V		0	—	10.0	μA
Quiescent supply current		I _{CC}	V _{IN} = V _{CC} or GND		1.2	—	20.0	μA
			V _{CC} ≤ V _{IN} ≤ 3.6 V		1.2	—	±20.0	

AC Characteristics (Ta = -40~85°C, Input: tr = tf = 2.0 ns)

Characteristics	Symbol	Test Condition	V _{CC} (V)	Min	Max	Unit
Propagation delay time (A, B, C- \bar{Y})	t _{pLH} t _{pHL}	Figure 1, Figure 2	C _L = 15 pF, R _L = 2 kΩ	1.2	3.0	41.0
				1.4 ± 0.1	2.0	16.4
			C _L = 30 pF, R _L = 500 Ω	1.8 ± 0.15	1.5	8.2
				2.5 ± 0.2	0.8	4.1
Propagation delay time (G1- \bar{Y})	t _{pLH} t _{pHL}	Figure 1, Figure 2	C _L = 15 pF, R _L = 2 kΩ	1.2	3.0	41.0
				1.4 ± 0.1	2.0	16.4
			C _L = 30 pF, R _L = 500 Ω	1.8 ± 0.15	1.5	8.2
				2.5 ± 0.2	0.8	4.1
Propagation delay time ($\bar{G}2$ - \bar{Y})	t _{pLH} t _{pHL}	Figure 1, Figure 2	C _L = 15 pF, R _L = 2 kΩ	1.2	3.0	41.0
				1.4 ± 0.1	2.0	16.4
			C _L = 30 pF, R _L = 500 Ω	1.8 ± 0.15	1.5	8.2
				2.5 ± 0.2	0.8	4.1
				3.3 ± 0.3	0.6	3.5

For C_L = 50 pF, add approximately 300 ps to the AC maximum specification.

Dynamic Switching Characteristics (Ta = 25°C, Input: tr = tf = 2.0 ns, C_L = 30 pF)

Characteristics	Symbol	Test Condition	V _{CC} (V)	Typ.	Unit
Quiet output maximum dynamic V _{OL}	V _{OLP}	V _{IH} = 1.8 V, V _{IL} = 0 V (Note11)	1.8	0.25	V
		V _{IH} = 2.5 V, V _{IL} = 0 V (Note11)	2.5	0.6	
		V _{IH} = 3.3 V, V _{IL} = 0 V (Note11)	3.3	0.8	
Quiet output minimum dynamic V _{OL}	V _{OLV}	V _{IH} = 1.8 V, V _{IL} = 0 V (Note11)	1.8	-0.25	V
		V _{IH} = 2.5 V, V _{IL} = 0 V (Note11)	2.5	-0.6	
		V _{IH} = 3.3 V, V _{IL} = 0 V (Note11)	3.3	-0.8	
Quiet output minimum dynamic V _{OH}	V _{OHV}	V _{IH} = 1.8 V, V _{IL} = 0 V (Note11)	1.8	1.5	V
		V _{IH} = 2.5 V, V _{IL} = 0 V (Note11)	2.5	1.9	
		V _{IH} = 3.3 V, V _{IL} = 0 V (Note11)	3.3	2.2	

Note 11: This parameter is guaranteed by design.

Capacitive Characteristics (Ta = 25°C)

Characteristics	Symbol	Test Condition	V _{CC} (V)	Typ.	Unit
Input capacitance	C _{IN}	—	1.8, 2.5, 3.3	6	pF
Power dissipation capacitance	C _{PD}	f _{IN} = 10 MHz (Note12)	1.8, 2.5, 3.3	40	pF

Note 12: C_{PD} is defined as the value of the internal equivalent capacitance which is calculated from the operating current consumption without load.

Average operating current can be obtained by the equation:

$$I_{CC (opr)} = C_{PD} \cdot V_{CC} \cdot f_{IN} + I_{CC}$$

AC Test Circuit

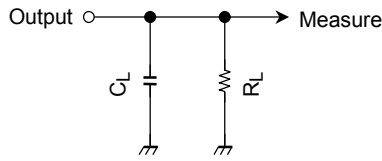

Symbol	V_{CC}	
		3.3 ± 0.3 V 2.5 ± 0.2 V 1.8 ± 0.15 V
R_L	500 Ω	2 kΩ
C_L	30 pF	15 pF

Figure 1

AC Waveform

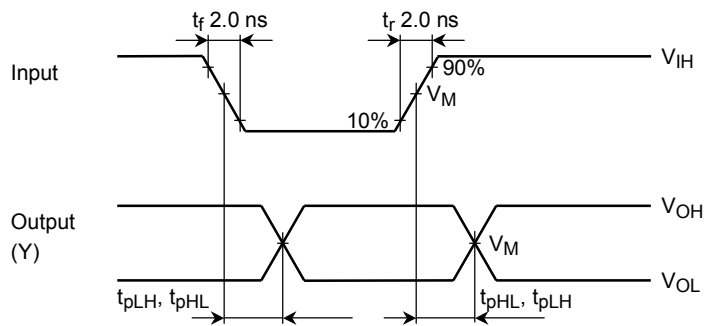

Symbol	V_{CC}				
		3.3 ± 0.3 V	2.5 ± 0.2 V	1.8 ± 0.15 V	1.5 ± 0.1 V
V_{IH}	2.7 V	V_{CC}	V_{CC}	V_{CC}	V_{CC}
V_M	1.5 V	$V_{CC}/2$	$V_{CC}/2$	$V_{CC}/2$	$V_{CC}/2$

Figure 2 t_{pLH} , t_{pHL}

Package Dimensions

VSSOP16-P-0030-0.50

Unit : mm

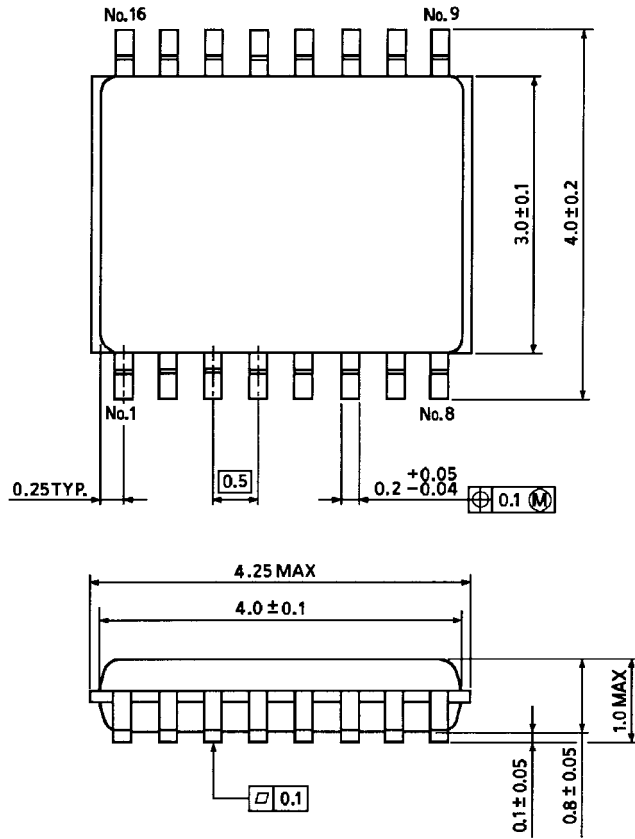

Weight: 0.02 g (typ.)

RESTRICTIONS ON PRODUCT USE

000707EBA

- TOSHIBA is continually working to improve the quality and reliability of its products. Nevertheless, semiconductor devices in general can malfunction or fail due to their inherent electrical sensitivity and vulnerability to physical stress. It is the responsibility of the buyer, when utilizing TOSHIBA products, to comply with the standards of safety in making a safe design for the entire system, and to avoid situations in which a malfunction or failure of such TOSHIBA products could cause loss of human life, bodily injury or damage to property.
In developing your designs, please ensure that TOSHIBA products are used within specified operating ranges as set forth in the most recent TOSHIBA products specifications. Also, please keep in mind the precautions and conditions set forth in the "Handling Guide for Semiconductor Devices," or "TOSHIBA Semiconductor Reliability Handbook" etc..
- The TOSHIBA products listed in this document are intended for usage in general electronics applications (computer, personal equipment, office equipment, measuring equipment, industrial robotics, domestic appliances, etc.). These TOSHIBA products are neither intended nor warranted for usage in equipment that requires extraordinarily high quality and/or reliability or a malfunction or failure of which may cause loss of human life or bodily injury ("Unintended Usage"). Unintended Usage include atomic energy control instruments, airplane or spaceship instruments, transportation instruments, traffic signal instruments, combustion control instruments, medical instruments, all types of safety devices, etc.. Unintended Usage of TOSHIBA products listed in this document shall be made at the customer's own risk.
- The products described in this document are subject to the foreign exchange and foreign trade laws.
- The information contained herein is presented only as a guide for the applications of our products. No responsibility is assumed by TOSHIBA CORPORATION for any infringements of intellectual property or other rights of the third parties which may result from its use. No license is granted by implication or otherwise under any intellectual property or other rights of TOSHIBA CORPORATION or others.
- The information contained herein is subject to change without notice.