

TOSHIBA BIPOLAR DIGITAL INTEGRATED CIRCUIT SILICON MONOLITHIC

TD62308BP-1, TD62308BF

4CH LOW INPUT ACTIVE HIGH-CURRENT DARLINGTON SINK DRIVER

The TD62308BP-1 and TD62308BF are non-inverting transistor array which are comprised of four NPN darlington output stages and PNP input stages.

This device is low level input active driver and are suitable for operation with TTL, 5 V CMOS and 5V Microprocessor which have sink current output drivers.

Applications include relay, hammer, lamp and stepping motor drivers.

FEATURES

- Two VCC Terminals VCC1, VCC2 (Separated)
- Package Type BP-1 : DIP-16 pin
BF : HSOP-16 pin
- High Sustaining Voltage Output: VCE (SUS) = 80 V (Min)
- Output Current (Single Output): IOU_T = 1.5 A (Max)
- Output Clamp Diodes
- Low Level Active Input
- GND and SUB Terminal = Heat Sink
- Input Compatible with TTL and 5 V CMOS
- Standard Supply Voltage

PIN CONNECTION (TOP VIEW)

TD62308BP-1

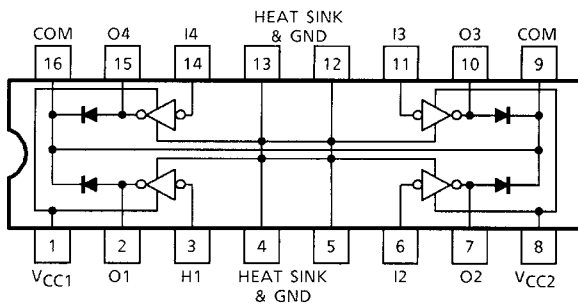

TD62308BF

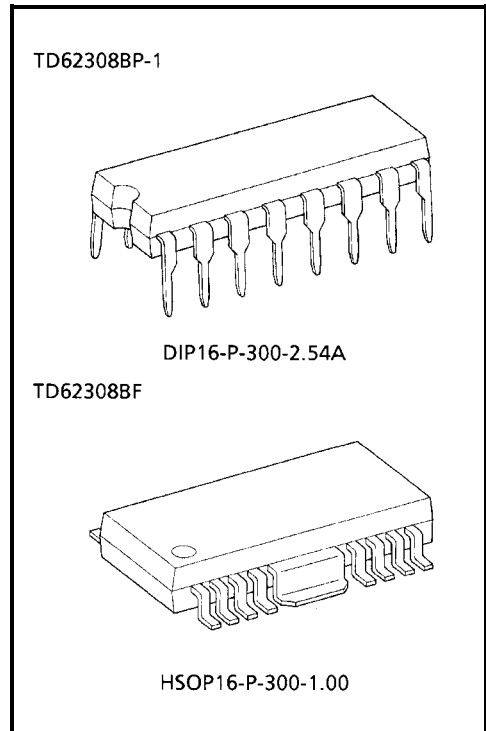
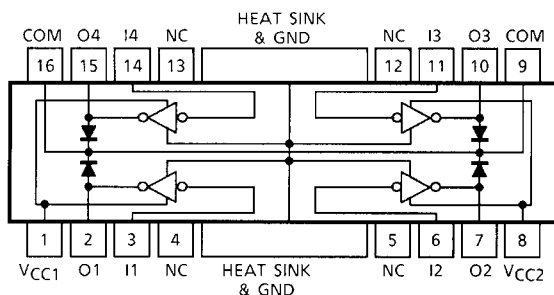

Weight

DIP16-P-300-2.54A : 1.11 g (Typ.)

HSOP16-P-300-1.00 : 0.50 g (Typ.)

SCHEMATICS (EACH DRIVER)

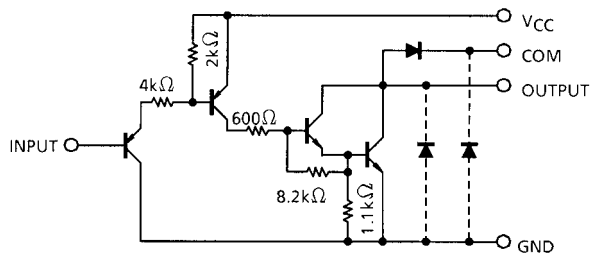

Note : The Output parasitic diodes cannot be used as clamp diodes.

PRECAUTIONS for USING

- (1) This IC does not include built-in protection circuits for excess current or overvoltage. If this IC is subjected to excess current or overvoltage, it may be destroyed. Hence, the utmost care must be taken when systems which incorporate this IC are designed. Utmost care is necessary in the design of the output line, VCC, COMMON and GND line since IC may be destroyed due to short-circuit between outputs, air contamination fault, or fault by improper grounding.
- (2) If a TD62308BP-1/BF is being used to drive an inductive load (such as a motor, solenoid or relay), Toshiba recommends that the diodes (pins 9 and 16) be connected to the secondary power supply pin so as to absorb the counter electromotive force generated by the load. Please adhere to the device's maximum ratings. Toshiba recommends that zener diodes be connected between the diodes (pins 9 and 16) and the secondary power supply pin (as the anode) so as to enable rapid absorption of the counter electromotive force. Again, please adhere to the device's maximum ratings.

MAXIMUM RATINGS (Ta = 25°C)

CHARACTERISTIC	SYMBOL	RATING	UNIT	
Supply Voltage	V _{CC}	7	V	
Output Sustaining Voltage	V _{CE(SUS)}	-0.5~80	V	
Parasitic Transistor Output Voltage	V _{CE(F)} (Note 1)	80	V	
Output Current	I _{OUT}	1.5	A / ch	
Input Current	I _{IN}	-10	mA	
Input Voltage	V _{IN}	7	V	
Clamp Diode Reverse Voltage	V _R	80	V	
Clamp Diode Forward Current	I _F	1.5	A	
Power Dissipation	BP-1	P _D	1.47 / 2.7 (Note 2)	W
	BF		0.9 / 1.4 (Note 3)	
Operating Temperature	T _{opr}	-40~85	°C	
Storage Temperature	T _{stg}	-55~150	°C	

Note 1: Parasitic Transistor (COMMON - GND - OUTPUT) Output Voltage

Note 2: On Glass Epoxy PCB (50 × 50 × 1.6 mm Cu 50%)

Note 3: On Glass Epoxy PCB (60 × 30 × 1.6 mm Cu 30%)

RECOMMENDED OPERATING CONDITIONS (Ta = -40~85°C)

CHARACTERISTIC		SYMBOL	CONDITION	MIN	TYP.	MAX	UNIT	
Supply Voltage		V _{CC}	—	4.5	—	5.0	V	
Output Sustaining Voltage		V _{CE (SUS)}	—	0	—	80	V	
Output Current	BP-1 (Note1) BP-1 (Note2)	I _{OUT}	DC 1 Circuit, Ta = 25°C	0	—	1.25	A / ch	
			T _{pw} = 25 ms 4 Circuits T _j = 120°C Ta = 85°C	Duty = 10%	0	—		1.20
				Duty = 50%	0	—		0.35
				Duty = 10%	0	—		0.75
				Duty = 50%	0	—		0.18
Input Voltage		V _{IN}	—	0	—	25	V	
Input Voltage	Output On	V _{IN (ON)}	—	0	—	V _{CC} -3.6	V	
	Output Off	V _{IN (OFF)}	—	V _{CC} -1.0	—	V _{CC}		
Clamp Diode Reverse Voltage		V _R	—	—	—	80	V	
Clamp Diode Forward Current		I _F	—	—	—	1.25	A	
Power Dissipation	BP-1	P _D	Ta = 85°C (Note 1)	—	—	1.4	W	
	BF		Ta = 85°C (Note 2)	—	—	0.7		

Note 1: On Glass Epoxy PCB (50 × 50 × 1.6 mm Cu 50%)

Note 2: On Glass Epoxy PCB (60 × 30 × 1.6 mm Cu 30%)

ELECTRICAL CHARACTERISTICS (Ta = 25°C)

CHARACTERISTIC		SYMBOL	TEST CIRCUIT	TEST CONDITION	MIN	TYP.	MAX	UNIT
Input Voltage	"H" level	V _{IH}	—	—	V _{CC} -1.6	—	V _{CC}	V
	"L" level	V _{IL}	—	—	—	—	V _{CC} -3.6	
Input Current	"H" level	I _{IH}	2	—	—	—	10	μA
	"L" level	I _{IL}	2	V _{CC} = 5.5 V, V _{IN} = 0.4 V	—	-0.05	-0.36	mA
Output Leakage Current		I _{CEX}	1	V _{OUT} = 80 V, Ta = 25°C	—	—	50	μA
				V _{OUT} = 80 V, Ta = 85°C	—	—	100	
Output Saturation Voltage		V _{CE (sat)}	3	V _{CC} = 4.5 V, I _{OUT} = 1.25 A	—	1.3	1.8	V
Clamp Diode Reverse Current		I _R	4	V _R = 80 V, Ta = 25°C	—	—	50	μA
Clamp Diode Forward Voltage		V _F	5	I _F = 1.25 A	—	1.5	2.0	V
Supply Current	Output On	I _{CC (ON)}	2	V _{CC} = 5.5 V, V _{IN} = 0 V	—	8.5	12.5	mA / ch
	Output Off	I _{CC (OFF)}	2	V _{CC} = 5.5 V, V _{IN} = V _{CC}	—	—	10	μA
Turn-On Delay		t _{ON}	6	V _{OUT} = 80 V, R _L = 68 Ω	—	0.2	—	μs
Turn-Off Delay		t _{OFF}			—	5.0	—	
Parasitic Transistor Output Voltage		V _{CEF}	7	I _{CEF} = 150 mA	80	—	—	V

TEST CIRCUIT

1. I_{CEX}

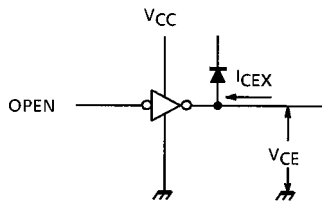

2. I_{CC}, I_{IN}

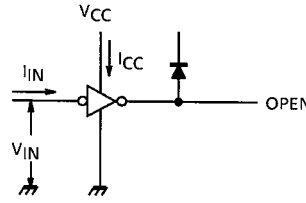

3. $V_{CE(sat)}$

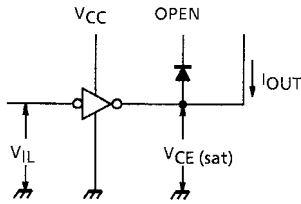

4. I_R

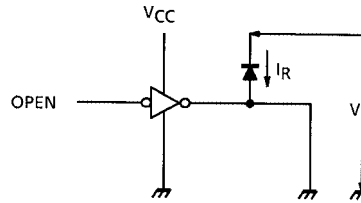

5. V_F

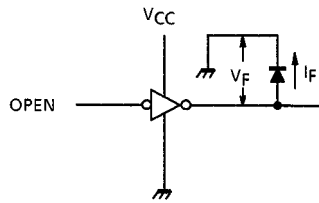

6. t_{ON}, t_{OFF}

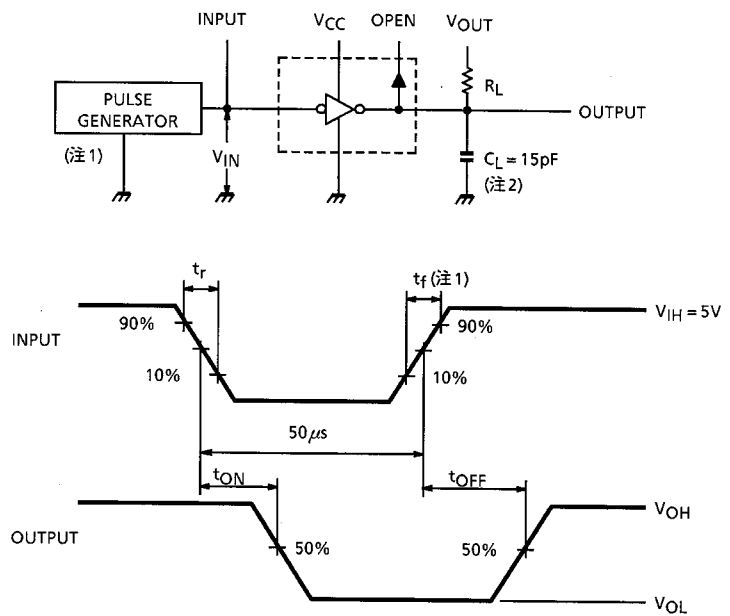

Note 1: Pulse width 50 μ s, Duty Cycle 10%
Output Impedance 50 Ω $t_r \leq 5$ ns, $t_f \leq 10$ ns

Note 2: C_L includes probe and jig capacitance.

7. V_{cef}

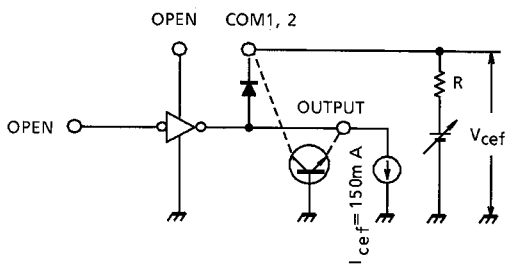

$I_{cef} = 150\text{mA}$
(at Single Pulse = 5ms)

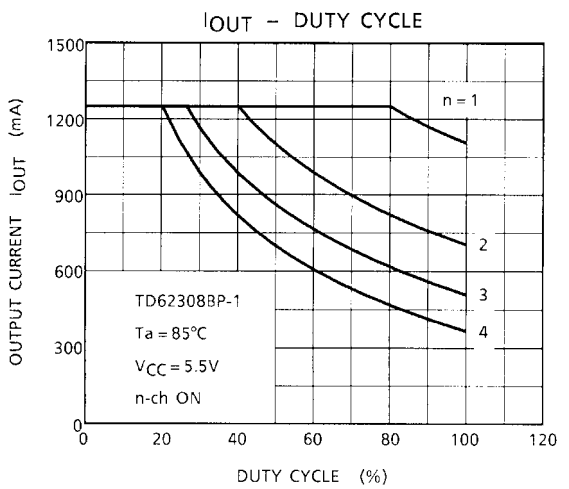
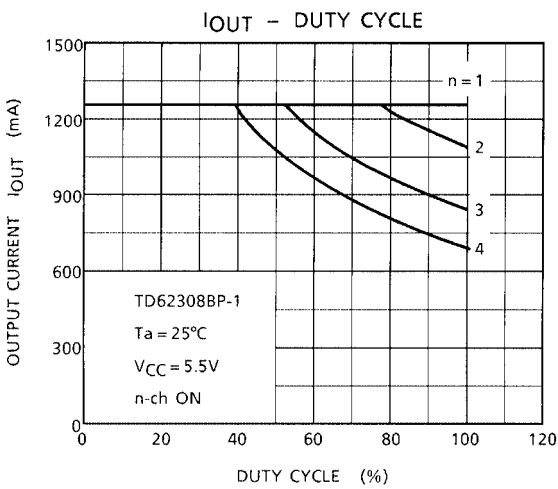
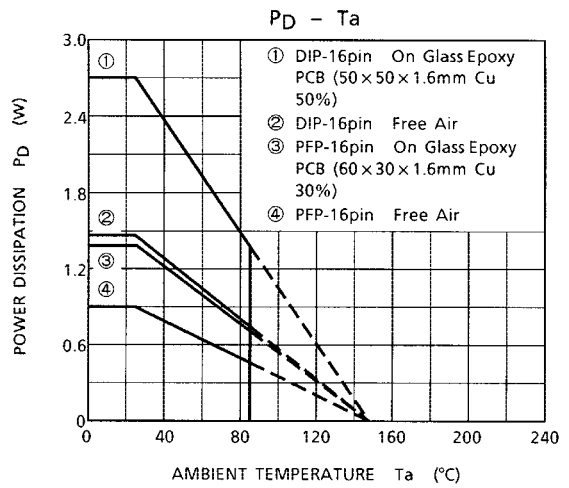
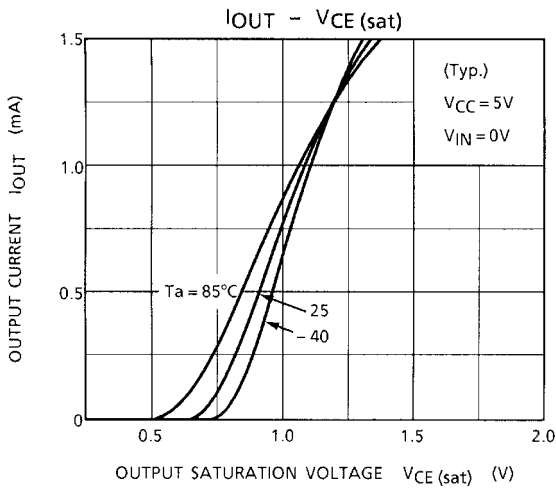
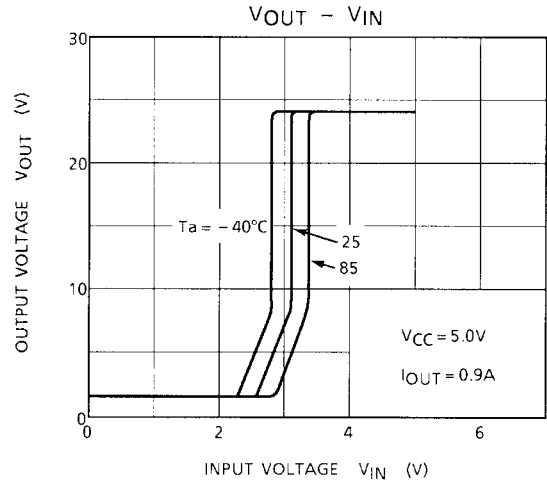
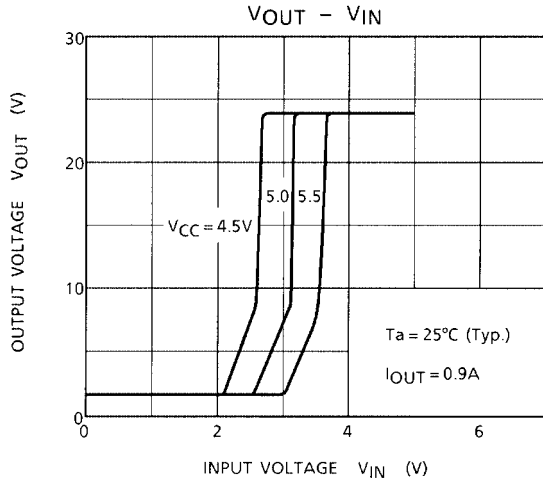

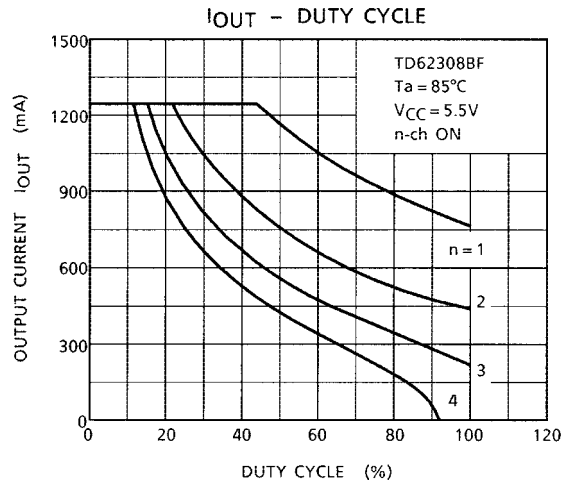
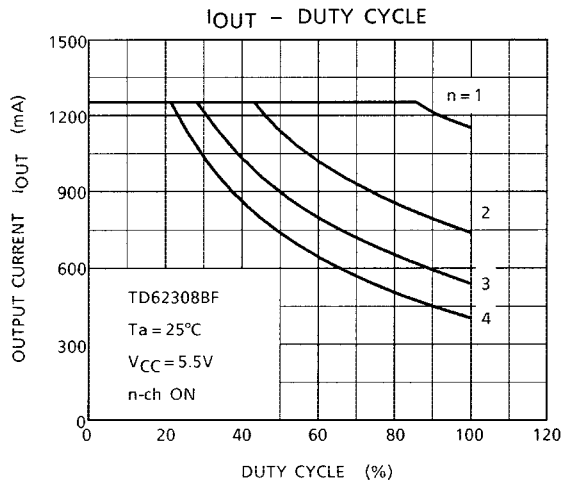

PACKAGE DIMENSIONS

DIP16-P-300-2.54A

Unit: mm

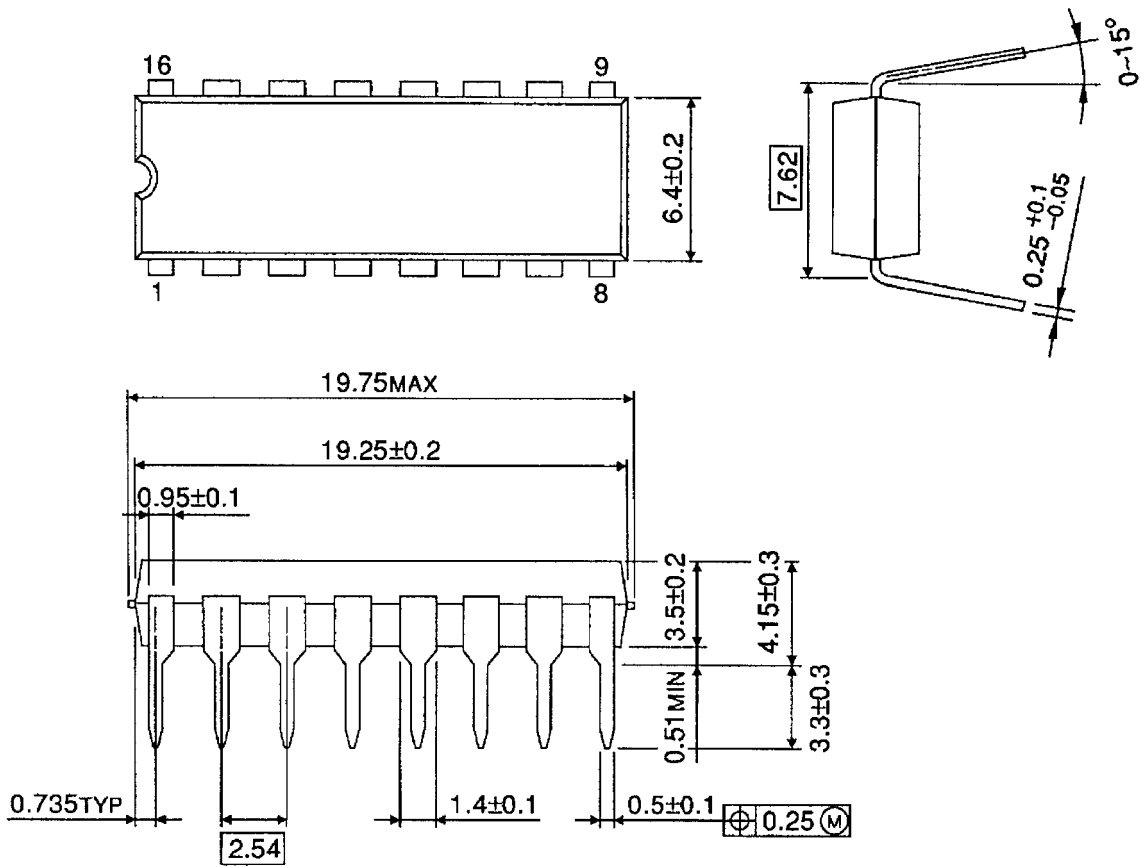

Weight: 1.11 g (Typ.)

PACKAGE DIMENSIONS

HSOP16-P-300-1.00

Unit: mm

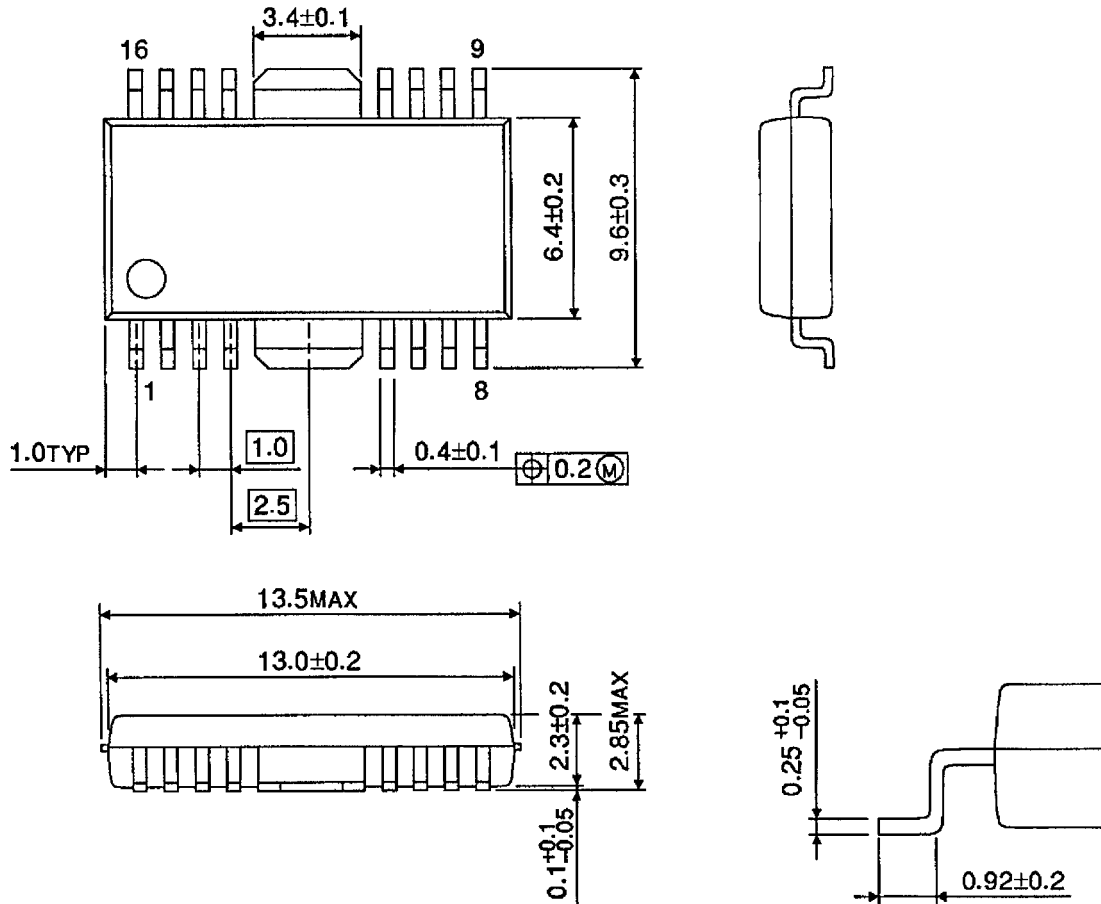

Weight: 0.50 g (Typ.)

RESTRICTIONS ON PRODUCT USE

000707EBA

- TOSHIBA is continually working to improve the quality and reliability of its products. Nevertheless, semiconductor devices in general can malfunction or fail due to their inherent electrical sensitivity and vulnerability to physical stress. It is the responsibility of the buyer, when utilizing TOSHIBA products, to comply with the standards of safety in making a safe design for the entire system, and to avoid situations in which a malfunction or failure of such TOSHIBA products could cause loss of human life, bodily injury or damage to property.
In developing your designs, please ensure that TOSHIBA products are used within specified operating ranges as set forth in the most recent TOSHIBA products specifications. Also, please keep in mind the precautions and conditions set forth in the "Handling Guide for Semiconductor Devices," or "TOSHIBA Semiconductor Reliability Handbook" etc..
- The TOSHIBA products listed in this document are intended for usage in general electronics applications (computer, personal equipment, office equipment, measuring equipment, industrial robotics, domestic appliances, etc.). These TOSHIBA products are neither intended nor warranted for usage in equipment that requires extraordinarily high quality and/or reliability or a malfunction or failure of which may cause loss of human life or bodily injury ("Unintended Usage"). Unintended Usage include atomic energy control instruments, airplane or spaceship instruments, transportation instruments, traffic signal instruments, combustion control instruments, medical instruments, all types of safety devices, etc.. Unintended Usage of TOSHIBA products listed in this document shall be made at the customer's own risk.
- The products described in this document are subject to the foreign exchange and foreign trade laws.
- The information contained herein is presented only as a guide for the applications of our products. No responsibility is assumed by TOSHIBA CORPORATION for any infringements of intellectual property or other rights of the third parties which may result from its use. No license is granted by implication or otherwise under any intellectual property or other rights of TOSHIBA CORPORATION or others.
- The information contained herein is subject to change without notice.