

TOSHIBA BIPOLAR DIGITAL INTEGRATED CIRCUIT SILICON MONOLITHIC

TD62703P, TD62703F

6CH HIGH VOLTAGE SOURCE DRIVER

The TD62703P, TD62703F is comprised of six source current Transistor Array.

These drivers are specifically designed for fluorescent display applications.

For proper operation, the substrate (SUB) must be connected to the most negative voltage.

FEATURES

- High output voltage : $V_{CC}, V_{OUT} = 60\text{ V (Min)}$
- Output current (single output) : $I_{OUT} = -50\text{ mA (Max)}$
- Input resistor : $R_{IN} = 2.7\text{ k}\Omega$
- Package type-P : DIP-14 pin
- Package type-F : SOP-14 pin

PIN CONNECTION (TOP VIEW)

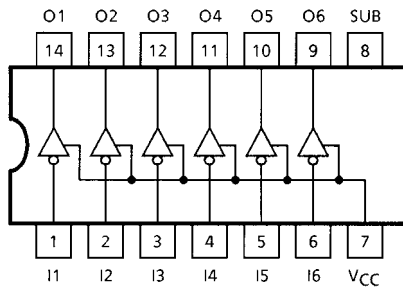

SCHEMATICS (EACH DRIVER)

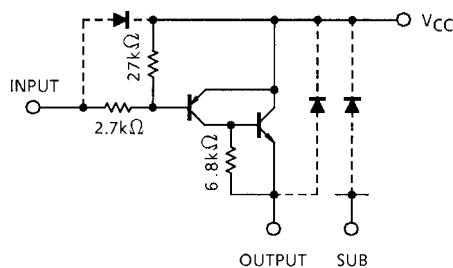

Note: The input and output parasitic diodes cannot be used as clamp diodes.

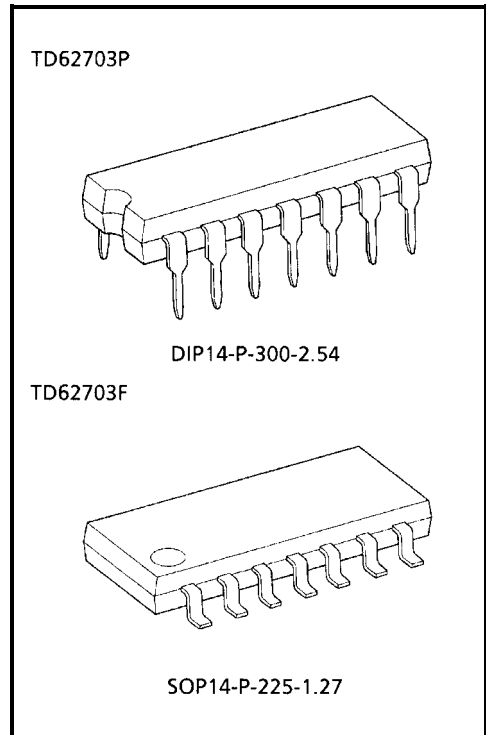

Weight
 DIP14-P-300-2.54 : 1.11 g (Typ.)
 SOP14-P-225-1.27 : 0.16 g (Typ.)

MAXIMUM RATINGS (Ta = 25°C)

CHARACTERISTIC		SYMBOL	RATING	UNIT
Supply Voltage		V _{SUB}	V _{CC} - 60	V
Output Sustaining Voltage		V _{OUT}	V _{CC} - 60	V
Input Voltage		V _{IN}	-30~0.5	V
Output Current		I _{OUT}	-50	mA / ch
Input Current		I _{IN}	10	mA
Power Dissipation	P	P _D (Note 2)	1.0	W
	F		0.625 (Note 1)	
Operating Temperature		T _{opr}	-40~85	°C
Storage Temperature		T _{stg}	-55~150	°C

Note 1: On Glass Epoxy PCB (50 × 50 × 1.6 mm Cu 50%)

Note 2: Delated above 25°C in the proportion 8.0mW / °C (P Type), 5.0mW / °C (F Type).

RECOMMENDED OPERATING CONDITIONS (Ta = -40~85°C)

CHARACTERISTIC		SYMBOL	CONDITION	MIN	TYP.	MAX	UNIT
Supply Voltage		V _{SUB}	V _{CC} = 0 V	V _{OUT}	—	-55	V
Output Sustaining Voltage		V _{OUT}		0	—	V _{SUB}	V
Output Current		I _{OUT}		0	—	-40	mA / ch
Input Voltage		V _{IN}		0	—	-7.0	V
Power Dissipation	P	P _D	—	—	0.36	W	
	F		On PCB (Note)	—	—		0.325

Note: On Glass Epoxy PCB (50 × 50 × 1.6 mm Cu 30%)

ELECTRICAL CHARACTERISTICS (Ta = 25°C)

CHARACTERISTIC		SYMBOL	TEST CIR-CUIT	TEST CONDITION	MIN	TYP.	MAX	UNIT
Output Leakage Current		I _{CEX}	1	V _{CC} = 0 V, V _{IN} = 0 V V _{OUT} = -55 V	—	—	-100	μA
Collector-Emitter Saturation Voltage		V _{CE (sat)}	2	I _{IN} = -1 mA, I _{OUT} = -40 mA	—	—	-2.5	V
DC Current Transfer Ratio		h _{FE}	2	V _{CE} = -5.0 V, I _{OUT} = -40 mA	100	—	—	—
Input Current	Output On	V _{IN (ON)}	3	V _{CC} = 0 V, V _{IN} = -5.1 V	—	-1.7	-2.4	mA
	Output Off	V _{IN (OFF)}			—	—	10	μA
Input Voltage	Output On	V _{IN (ON)}	4	V _{CC} = 0 V	-3.0	—	—	V
	Output Off	V _{IN (OFF)}			—	—	-0.44	
Turn-On Delay	P	t _{ON}	5	V _{CC} = 0 V, V _{SUB} = V _{OUT} = -55 V R _L = 1.4 kΩ, C _L = 15 pF	—	1	—	μs
	F				—	0.5	—	
Turn-Off Delay	P	t _{ON}	5	V _{CC} = 0 V, V _{SUB} = V _{OUT} = -55 V R _L = 1.4 kΩ, C _L = 15 pF	—	2	—	μs
	F				—	1	—	

TEST CIRCUIT

1. I_{CEX}

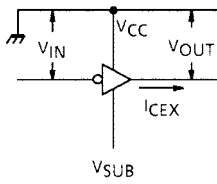

2. V_{CE (sat)}, h_{FE}

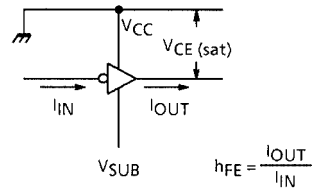

3. I_{IN (ON)}, I_{IN (OFF)}

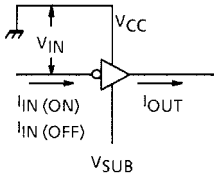

4. V_{IN (ON)}, I_{IN (OFF)}

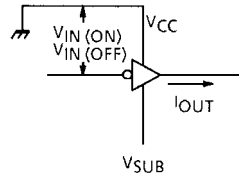

5. t_{ON}, t_{OFF}

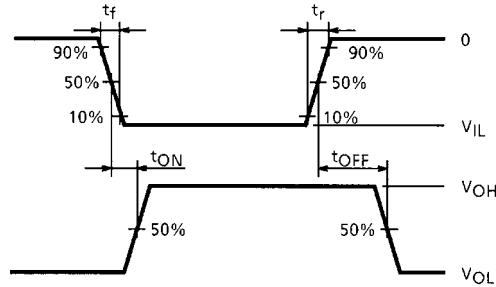
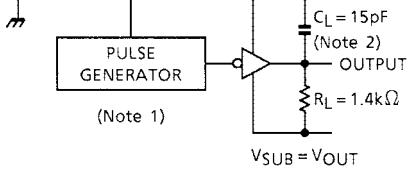

Note 1: Pulse width 50 μs, Duty Cycle 10%
 Output Impedance 50 Ω, t_r ≤ 10 ns, t_f ≤ 5 ns
 Note 2: C_L includes probe and jig capacitance.

PRECAUTIONS for USING

This IC does not integrate protection circuits such as overcurrent and overvoltage protectors. Thus, if excess current or voltage is applied to the IC, the IC may be damaged. Please design the IC so that excess current or voltage will not be applied to the IC. Utmost care is necessary in the design of the output line, V_{CC} and GND (SUB) line since IC may be destroyed due to short-circuit between outputs, air contamination fault, or fault by improper grounding.

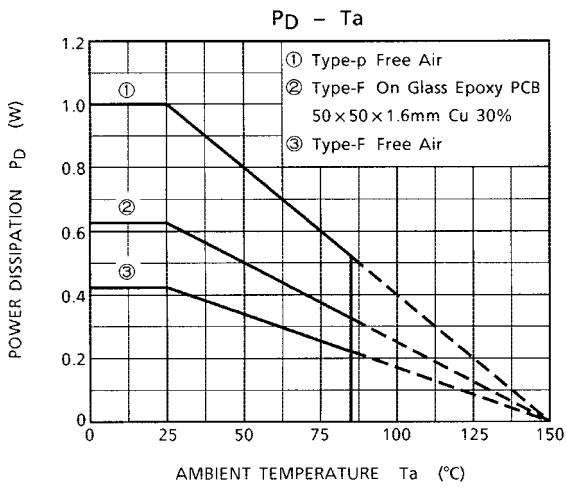
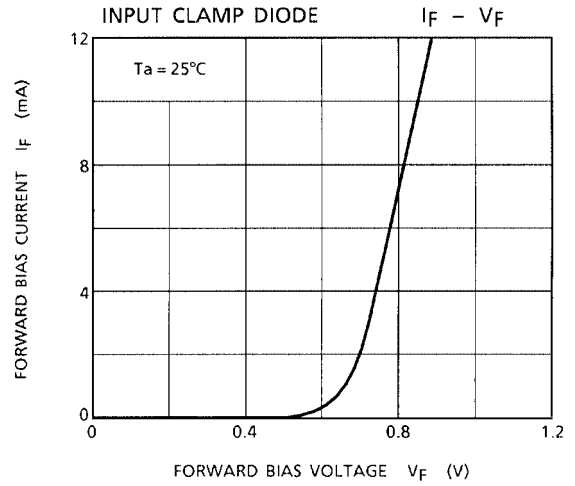
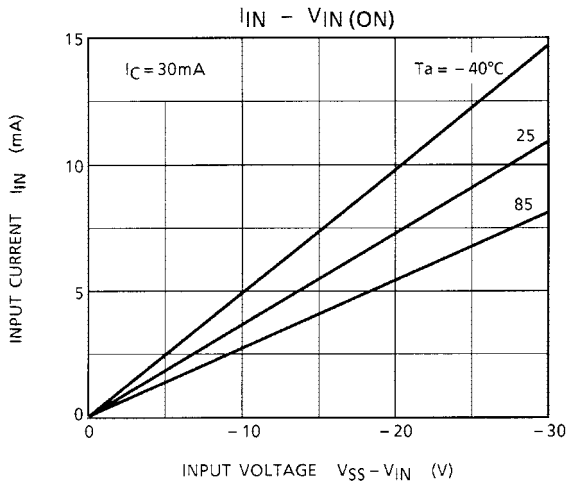

PACKAGE DIMENSIONS

DIP14-P-300-2.54

Unit: mm

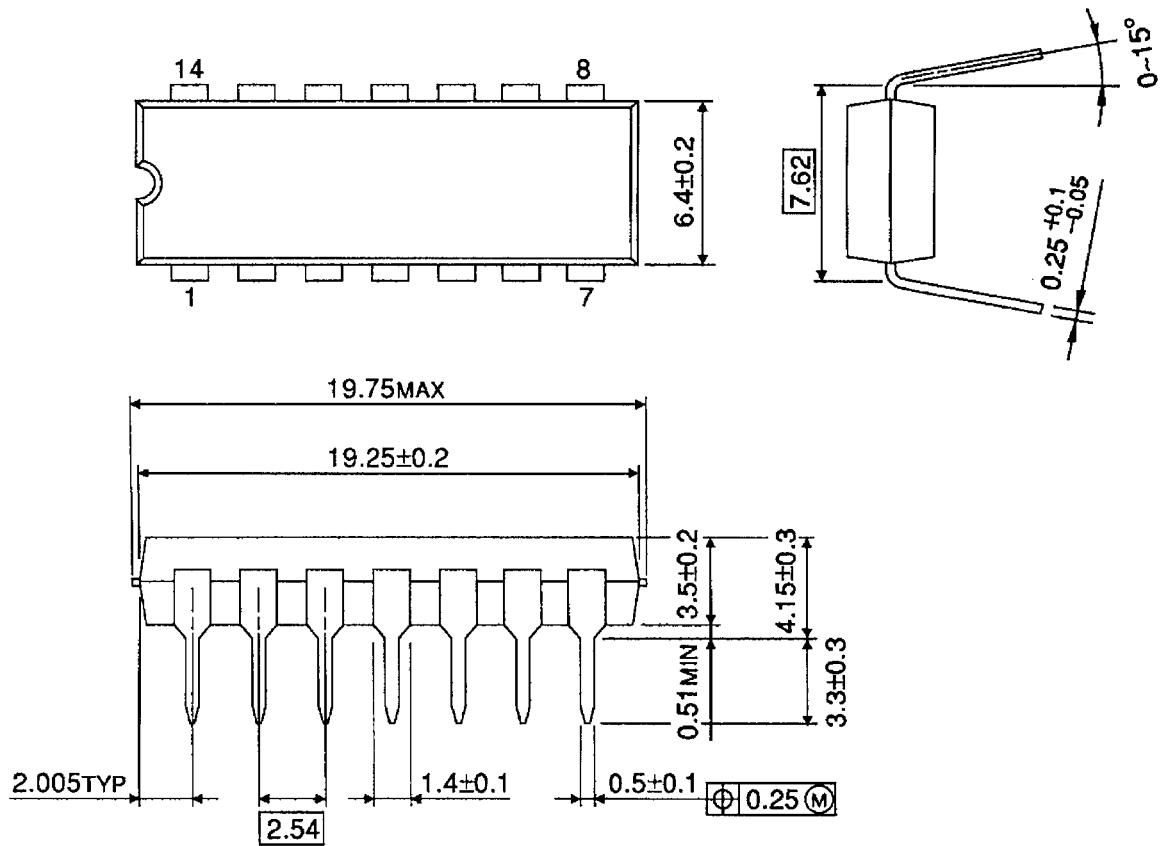

Weight: 1.11 g (Typ.)

PACKAGE DIMENSIONS

SOP14-P-225-1.27

Unit: mm

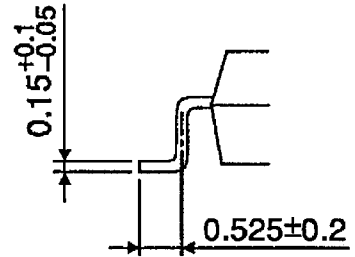
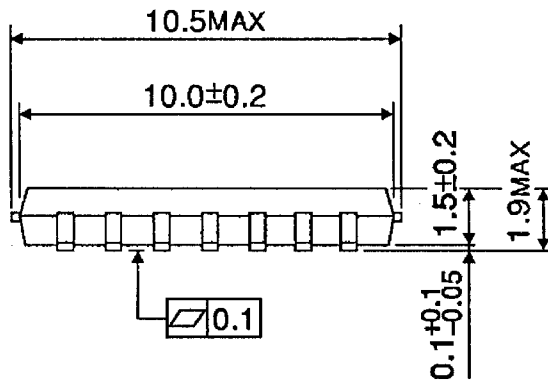
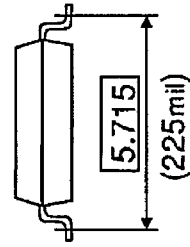
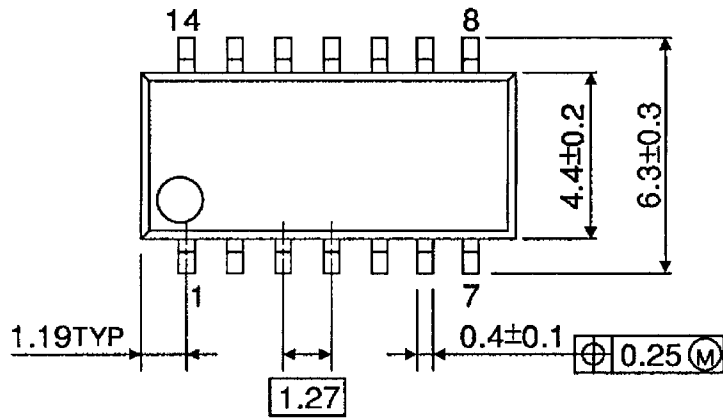

Weight: 0.16 g (Typ.)

RESTRICTIONS ON PRODUCT USE

000707EBA

- TOSHIBA is continually working to improve the quality and reliability of its products. Nevertheless, semiconductor devices in general can malfunction or fail due to their inherent electrical sensitivity and vulnerability to physical stress. It is the responsibility of the buyer, when utilizing TOSHIBA products, to comply with the standards of safety in making a safe design for the entire system, and to avoid situations in which a malfunction or failure of such TOSHIBA products could cause loss of human life, bodily injury or damage to property.
In developing your designs, please ensure that TOSHIBA products are used within specified operating ranges as set forth in the most recent TOSHIBA products specifications. Also, please keep in mind the precautions and conditions set forth in the "Handling Guide for Semiconductor Devices," or "TOSHIBA Semiconductor Reliability Handbook" etc..
- The TOSHIBA products listed in this document are intended for usage in general electronics applications (computer, personal equipment, office equipment, measuring equipment, industrial robotics, domestic appliances, etc.). These TOSHIBA products are neither intended nor warranted for usage in equipment that requires extraordinarily high quality and/or reliability or a malfunction or failure of which may cause loss of human life or bodily injury ("Unintended Usage"). Unintended Usage include atomic energy control instruments, airplane or spaceship instruments, transportation instruments, traffic signal instruments, combustion control instruments, medical instruments, all types of safety devices, etc.. Unintended Usage of TOSHIBA products listed in this document shall be made at the customer's own risk.
- The products described in this document are subject to the foreign exchange and foreign trade laws.
- The information contained herein is presented only as a guide for the applications of our products. No responsibility is assumed by TOSHIBA CORPORATION for any infringements of intellectual property or other rights of the third parties which may result from its use. No license is granted by implication or otherwise under any intellectual property or other rights of TOSHIBA CORPORATION or others.
- The information contained herein is subject to change without notice.