

TOSHIBA BIPOLAR DIGITAL INTEGRATED CIRCUIT SILICON MONOLITHIC

TD62705P,TD62705F,TD62706P,TD62706F

6CH HIGH-VOLTAGE SOURCE DRIVER

The TD62705P, TD62705F and TD62706P, TD62706F are comprised of six source current transistor array.

These drivers are specifically designed for fluorescent display applications.

For proper operation, the substrate (SUB) must be connected to the most negative voltage.

FEATURES

- High output voltage : $V_{CC} - V_{OUT} = 60 \text{ V (Min)}$
- Output current (single output) : $I_{OUT} = -50 \text{ mA (Max)}$
- Input compatible with various types of logic
 TD62705P, TD62705F $R_{IN} = 47 \text{ k}\Omega$: 6~25 V PMOS, CMOS
 TD62706P, TD62706F $R_{IN} = 10 \text{ k}\Omega$: TTL, 5 V CMOS
- Package type-P: DIP-16 pin
- Package type-F: SOP-16 pin

PIN CONNECTION (TOP VIEW)

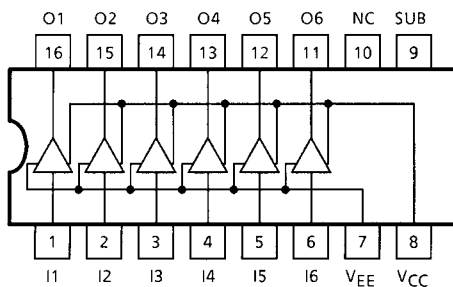

SCHEMATICS (EACH DRIVER)

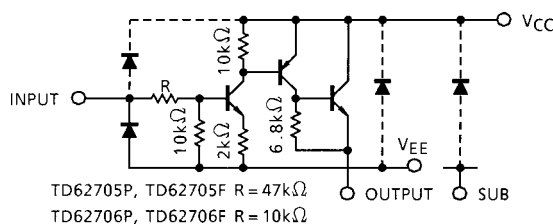

Note: The input and output parasitic diodes cannot be used as clamp diodes.

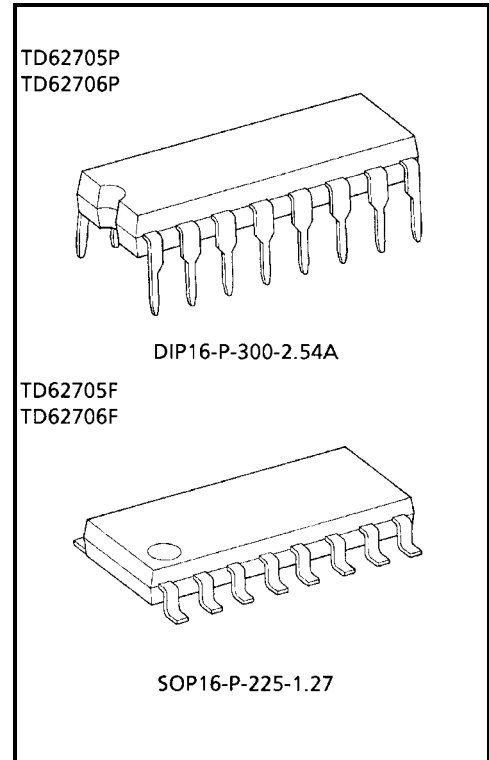

Weight
 DIP16-P-300-2.54A: 1.11 g (Typ.)
 SOP16-P-225-1.27 : 0.16 g (Typ.)

MAXIMUM RATINGS (Ta = 25°C)

CHARACTERISTIC		SYMBOL	RATING	UNIT
Supply Voltage		$V_{CC} - V_{EE}$	30	V
		$V_{CC} - V_{SUB}$	60	
Output Voltage		$V_{CC} - V_{OUT}$	-60	V
Input Voltage		$V_{IN} - V_{EE}$	$V_{CC} - V_{EE}$	V
Output Current		I_{OUT}	-50	mA / ch
Input Current		I_{IN}	±10	mA
Power Dissipation	P	P_D (Note 2)	1.0	W
	F		0.625 (Note 1)	
Operating Temperature		T_{opr}	-40~85	°C
Storage Temperature		T_{stg}	-55~150	°C

Note 1: On Glass Epoxy PCB (30 × 30 × 1.6 mm Cu 50%)

Note 2: Delated above 25°C in the proportion 8.0 mw / °C (P Type), 5.0 mw / °C (F Type).

RECOMMENDED OPERATING CONDITIONS (Ta = -40~85°C)

CHARACTERISTIC		SYMBOL	CONDITION	MIN	TYP.	MAX	UNIT
Supply Voltage	TD62705P TD62705F	V_{CC}	$V_{EE} = 0 V$	6.0	—	25	V
	TD62706P TD62706F			4.5	—	25	
		V_{SUB}	$V_{CC} = 0 V$	V_{OUT}	—	-55	
Output Voltage		V_{OUT}	$V_{CC} = 0 V$	0	—	-55	V
Output Current		I_{OUT}	—	0	—	-40	mA / ch
Input Voltage	TD62705P TD62705F	V_{IN}	$V_{EE} = 0 V, V_{CC} = 25 V$	0	—	25	V
	TD62706P TD62706F			0	—	7	
Power Dissipation	P	P_D	—	—	—	0.36	W
	F		On PCB (Note)	—	—	0.325	

Note: On Glass Epoxy PCB (50 × 50 × 1.6 mm, Cu 50%)

ELECTRICAL CHARACTERISTICS (Ta = 25°C)

CHARACTERISTIC		SYMBOL	TEST CIR-CUIT	TEST CONDITION	MIN	TYP.	MAX	UNIT	
Input Voltage	"H" Level	TD62705P TD62705F	V _{IH}	1	V _{EE} = 0 V	6.0	—	—	V
		TD62706P TD62706F			V _{EE} = 0 V	2.2	—	—	
	"L" Level	TD62705P TD62705F	V _{IL}	1	V _{EE} = 0 V	—	—	2.2	
		TD62706P TD62706F			V _{EE} = 0 V	—	—	0.8	
Input Current	"H" Level	TD62705P TD62705F	I _{IH}	2	V _{EE} = 0 V, V _{IN} = 6.0 V	—	0.11	0.16	mA
		TD62706P TD62706F			V _{EE} = 0 V, V _{IN} = 2.4 V	—	0.12	0.18	
	"L" Level	I _{IL}	2	V _{EE} = V _{IN} = 0 V, V _{CC} = 25 V	—	—	±1	μA	
Output Leakage Current		I _{CEX}	3	V _{EE} = 0 V, V _{CC} = 25 V V _{IN} = V _{IL} MAX. I _{OUT} = -30 V	—	—	-100	μA	
Collector-Emitter Saturation Voltage		V _{CE (sat)}	4	V _{EE} = 0 V, V _{CC} = V _{CC} MIN. V _{IN} = V _{IH} MIN. I _{OUT} = -40 mA	—	—	V _{CC} - 2.5	V	
Supply Current (Output On)	TD62705P TD62705F	I _{CC}	1	V _{EE} = 0 V, V _{CC} = 25 V V _{IN} = V _{IN} MAX. I _{OUT} = 0 mA	—	—	32	mA	
	TD62706P TD62706F				—	—	25		
Turn-On Delay		t _{ON}	5	R _L = 1.4 kΩ, C _L = 15 pF	—	0.2	—	μs	
Turn-Off Delay		t _{OFF}			—	1.5	—	μs	

TEST CIRCUIT

1. V_{IH} , V_{IL} , I_{CC}

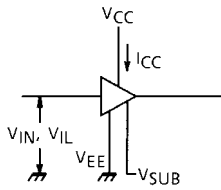

2. I_{IH} , I_{IL}

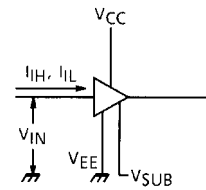

3. I_{CEX}

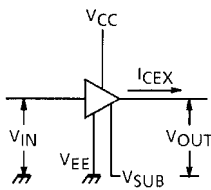

4. $V_{CE(sat)}$

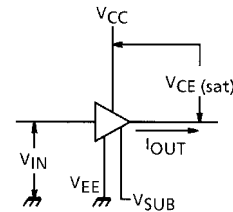

5. t_{ON} , t_{OFF}

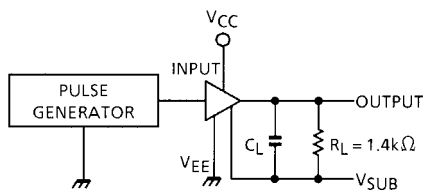

$C_L = 15 \text{ pF}$
(Includes probe and jig capacitance)

INPUT CONDITION

TYPE NAME	V_{IN}	V_{CC}	V_{SUB}
TD62705P, TD62705F	0-9V	25V	-30
TD62706P, TD62706F	0-3V	25V	-30

V_{IN} : Pulse Width 50 μs
Duty Cycle 50%
 $t_r \leq 5 \text{ ns}$
 $t_f \leq 10 \text{ ns}$

PRECAUTIONS for USING

This IC does not integrate protection circuits such as overcurrent and overvoltage protectors. Thus, if excess current or voltage is applied to the IC, the IC may be damaged. Please design the IC so that excess current or voltage will not be applied to the IC. Utmost care is necessary in the design of the output line, V_{CC} and GND (SUB, V_{EE}) line since IC may be destroyed due to short-circuit between outputs, air contamination fault, or fault by improper grounding.

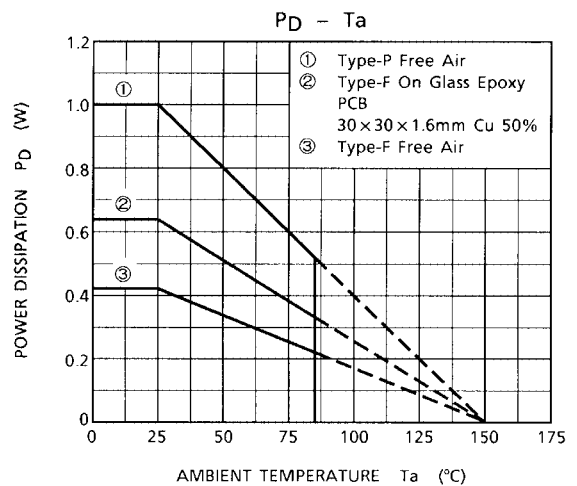
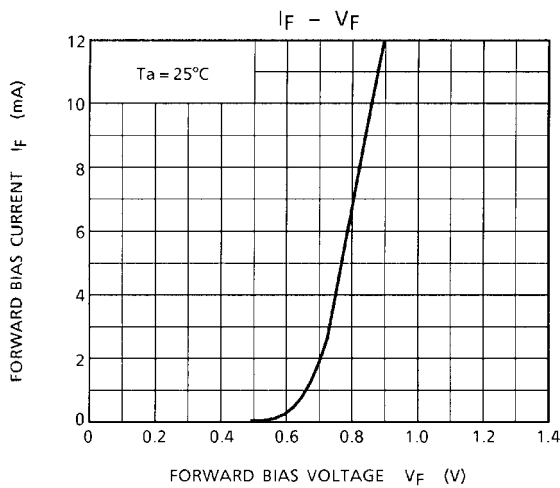
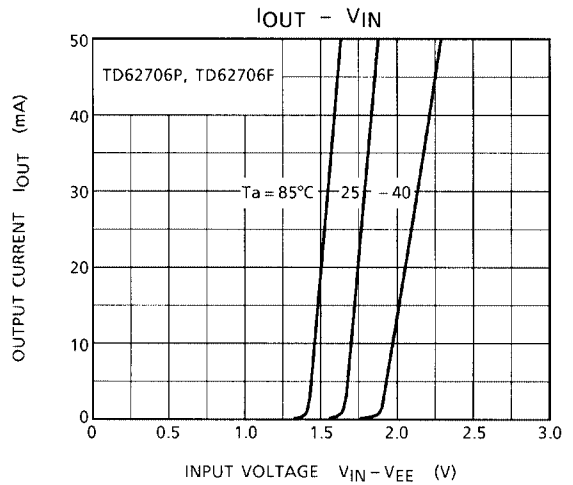
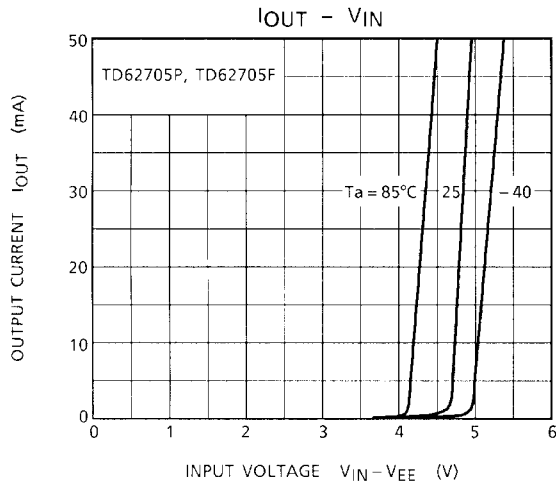
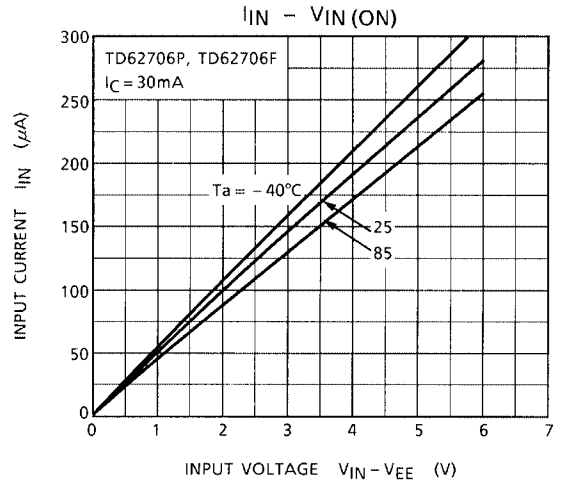
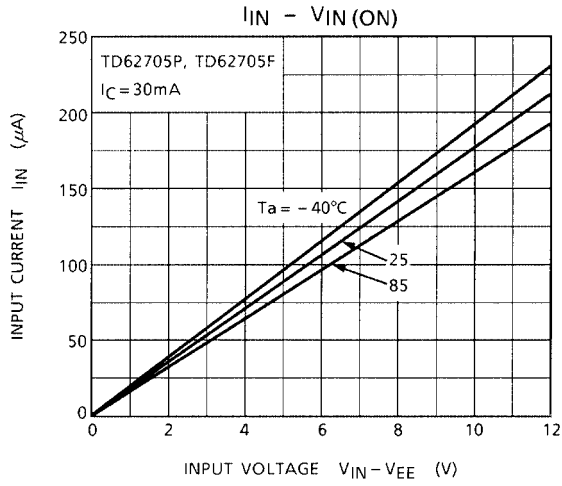

PACKAGE DIMENSIONS

DIP16-P-300-2.54A

Unit: mm

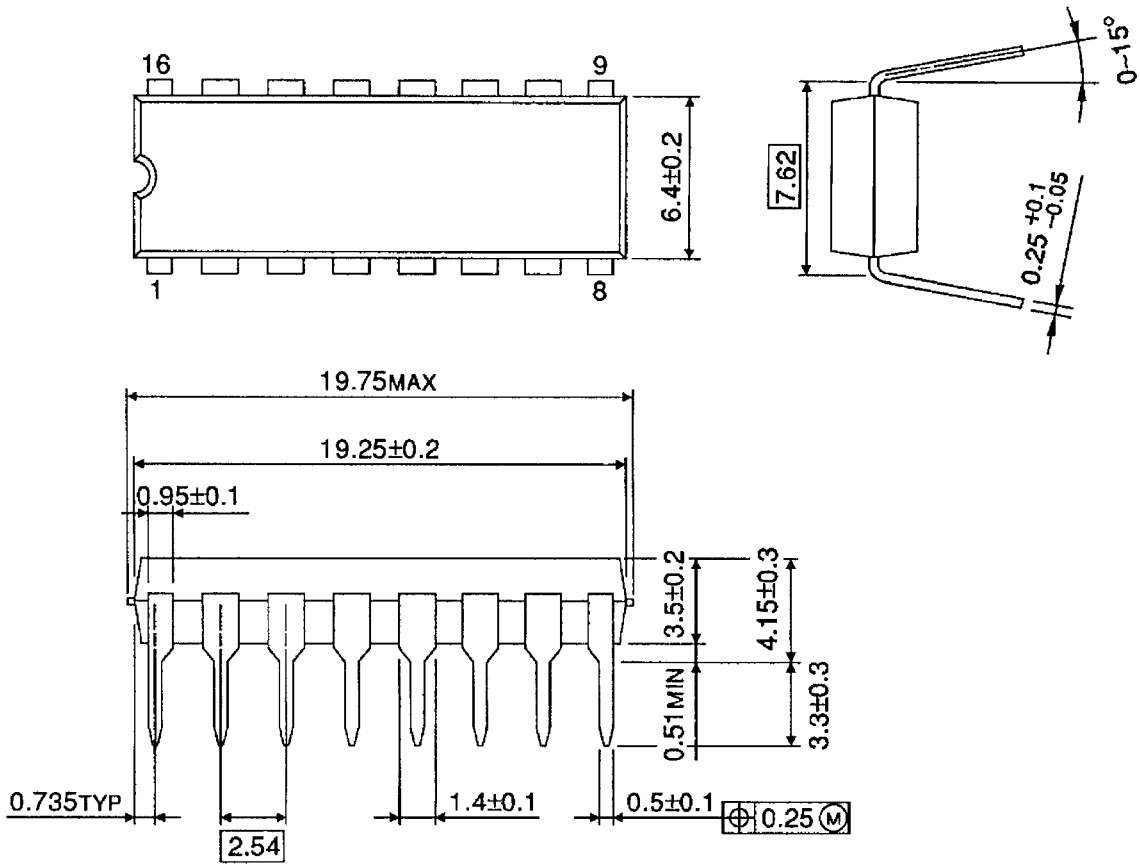

Weight: 1.11 g (Typ.)

PACKAGE DIMENSIONS

SOP16-P-225-1.27

Unit: mm

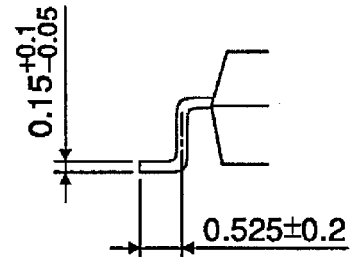
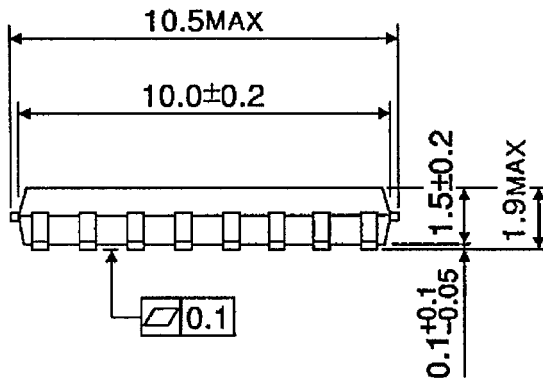
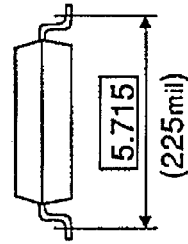
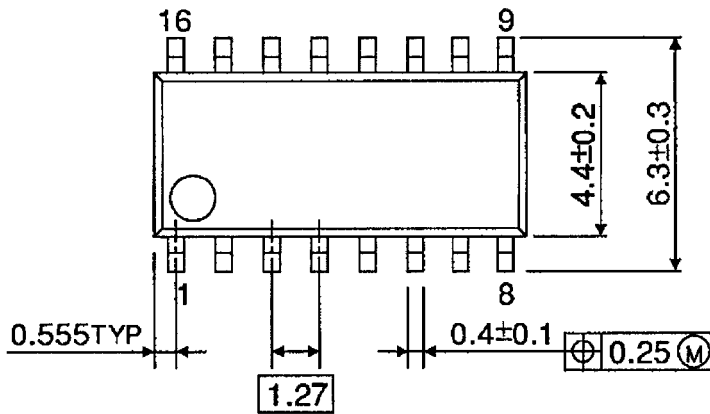

Weight: 0.16 g (Typ.)

RESTRICTIONS ON PRODUCT USE

000707EBA

- TOSHIBA is continually working to improve the quality and reliability of its products. Nevertheless, semiconductor devices in general can malfunction or fail due to their inherent electrical sensitivity and vulnerability to physical stress. It is the responsibility of the buyer, when utilizing TOSHIBA products, to comply with the standards of safety in making a safe design for the entire system, and to avoid situations in which a malfunction or failure of such TOSHIBA products could cause loss of human life, bodily injury or damage to property.
In developing your designs, please ensure that TOSHIBA products are used within specified operating ranges as set forth in the most recent TOSHIBA products specifications. Also, please keep in mind the precautions and conditions set forth in the "Handling Guide for Semiconductor Devices," or "TOSHIBA Semiconductor Reliability Handbook" etc..
- The TOSHIBA products listed in this document are intended for usage in general electronics applications (computer, personal equipment, office equipment, measuring equipment, industrial robotics, domestic appliances, etc.). These TOSHIBA products are neither intended nor warranted for usage in equipment that requires extraordinarily high quality and/or reliability or a malfunction or failure of which may cause loss of human life or bodily injury ("Unintended Usage"). Unintended Usage include atomic energy control instruments, airplane or spaceship instruments, transportation instruments, traffic signal instruments, combustion control instruments, medical instruments, all types of safety devices, etc.. Unintended Usage of TOSHIBA products listed in this document shall be made at the customer's own risk.
- The products described in this document are subject to the foreign exchange and foreign trade laws.
- The information contained herein is presented only as a guide for the applications of our products. No responsibility is assumed by TOSHIBA CORPORATION for any infringements of intellectual property or other rights of the third parties which may result from its use. No license is granted by implication or otherwise under any intellectual property or other rights of TOSHIBA CORPORATION or others.
- The information contained herein is subject to change without notice.