

Type	Ordering code	Package
TDA 4290-2	Q 67000-A 1359	} DIP 14
TDA 4290-2 S	Q67000-A1359-E20	

Tone control IC for the DC voltage control of volume, treble, and bass. The volume characteristic can be changed from linear to physiological.

For mono application we recommend the TDA 4290-2, while the TDA 4290-2 S is especially suitable for stereo application.

### Features

- Few external components
- High signal-to-noise ratio
- Low total harmonic distortion
- Complies with the IEC 268-3 standards

### Maximum ratings

Supply voltage	$V_S$	18	V
Control inputs	$V_5, V_8, V_{14}$	0 to $V_S$	V
Input signal	$V_{8rms}$	3	V
Load current	$I_2$	10	mA
Junction temperature	$T_j$	150	°C
Storage temperature range	$T_{stg}$	-40 to 125	°C
Thermal resistance (system-air)	$R_{thSA}$	90	K/W

### Operating range

Supply voltage	$V_S$	10.5 to 18	V
Volume control	$V_5$	0 to $0.51 \times V_2$	V
Frequency (-1 dB)	$f_i$	20 to 20,000	Hz
Ambient temperature	$T_A$	0 to 70	°C

**Characteristics**

$V_S = 14 \text{ V}$ ;  $T_A = 25^\circ\text{C}$

Measurement circuit 1

	min	typ	max	
Current consumption				$I_S$ mA
Reference voltage				$V_2$ V
Input resistance				$R_{i9}$ k $\Omega$
Output resistance				$R_{q3/6}$ $\Omega$
Changeover current				$I_4$ mA
Input current for set inputs				$-I_{5/8/14}$ $\mu\text{A}$
$V_{5/8/14} = 0.5 \times V_2$				

**Attenuation**

$V_{i,rms} = 300 \text{ mV}$ ,  $f_i = 1.6 \text{ kHz}$ ,  $V_8 = 0.5 \times V_2$ ,  $V_{14} = 0.49 \times V_2$ , S1 on physiological

$V_5 = 0.51 \times V_2$	$V_{q0} = V_q/V_i$	-3	0	3	dB
$V_5 = 0.41 \times V_2$	$V_q/V_{q0}$	-17	-15	-13	dB
$V_5 = 0.33 \times V_2$	$V_q/V_{q0}$	-33	-30	-27	dB
$V_5 = 0.25 \times V_2$	$V_q/V_{q0}$	-48	-44	-40	dB
Max. attenuation	$V_q/V_{q0}$	-75	-80		dB

**Frequency response**

$V_{i,rms} = 300 \text{ mV}$ ,  $V_5 = 0.51 \times V_2$ , S1 any

Linearity $V_8 = 0.5 \times V_2$	$V_q/V_{q8}$	-3	0	3	dB
$V_{14} = 0.49 \times V_2$ , $f = 40$ to $15,000 \text{ Hz}$					
Influence at $f = 1 \text{ kHz}$					
Trebles/basses max.	$V_q/V_{q0}$		2	3	dB
Trebles/basses min.	$V_q/V_{q0}$	-3	-2		dB
Treble emphasis	$V_q/V_{q80}$	+15	+17		dB
$f_i = 15 \text{ kHz}$ , $V_{14} = V_2$ , $V_8 = 0.5 \times V_2$					
Treble deemphasis	$V_q/V_{q80}$		-17	-15	dB
$f_i = 15 \text{ kHz}$ , $V_{14} = 0 \text{ V}$ , $V_8 = 0.5 \times V_2$					
Bass emphasis	$V_q/V_{q80}$	+15	+17		dB
$f_i = 40 \text{ Hz}$ , $V_8 = V_2$ , $V_{14} = 0.49 \times V_2$					
Bass deemphasis	$V_q/V_{q80}$		-17	-15	dB
$f_i = 40 \text{ Hz}$ , $V_8 = 0 \text{ V}$ , $V_{14} = 0.49 \times V_2$					
Total harmonic distortion	THD		0.1	0.5	%
$V_{i,rms} = 300 \text{ mV}$ , $f_i = 40 \text{ Hz}$ to $15 \text{ kHz}$ , control unit in 0 dB position					
Disturbance voltage	$V_{d,rms}$		30	50	$\mu\text{V}$
$f_i = 20$ to $20,000 \text{ Hz}$ , tone control in 0 dB position, volume -20 dB					

**Physiology tone control in 0 dB position**

$V_{rms} = 300$  mV, S1 at physiology

		$f = 40$ Hz			$f = 15$ kHz			
		min	typ	max	min	typ	max	
$V_q/V_{q0} = -15$ dB	$V_q/V_{q0}$	-11.0	- 9.0	- 7.0	-16.5	-13.5	-10.5	dB
$V_q/V_{q0} = -30$ dB	$V_q/V_{q0}$	-20.5	-17.5	-14.5	-28.0	-25.0	-22.0	dB
$V_q/V_{q0} = -45$ dB	$V_q/V_{q0}$	-30.0	-27.0	-24.0	-41.0	-37.0	-33.0	dB

**Synchronous operation** (measurement circuit 2)

$V_{rms} = 300$  mV,  $f_i = 1.6$  kHz,  $V_3 = 0.5 \times V_2$ ,  $V_{14} = 0.49 \times V_2$ , S1 at physiology

		min	typ	max	
$V_{q1}/V_i = 0$ dB	$V_{q1}/V_{q2}$	-1	0	1	dB
$V_{q1}/V_i = -15$ dB	$V_{q1}/V_{q2}$	-1.5	0	1.5	dB
$V_{q1}/V_i = -30$ dB	$V_{q1}/V_{q2}$	-2	0	2	dB
$V_{q1}/V_i = -45$ dB	$V_{q1}/V_{q2}$	-2.5	0	2.5	dB
$V_{q1}/V_i = -60$ dB	$V_{q1}/V_{q2}$	-3	0	3	dB



**Measurement circuit 2 (stereo operation)**

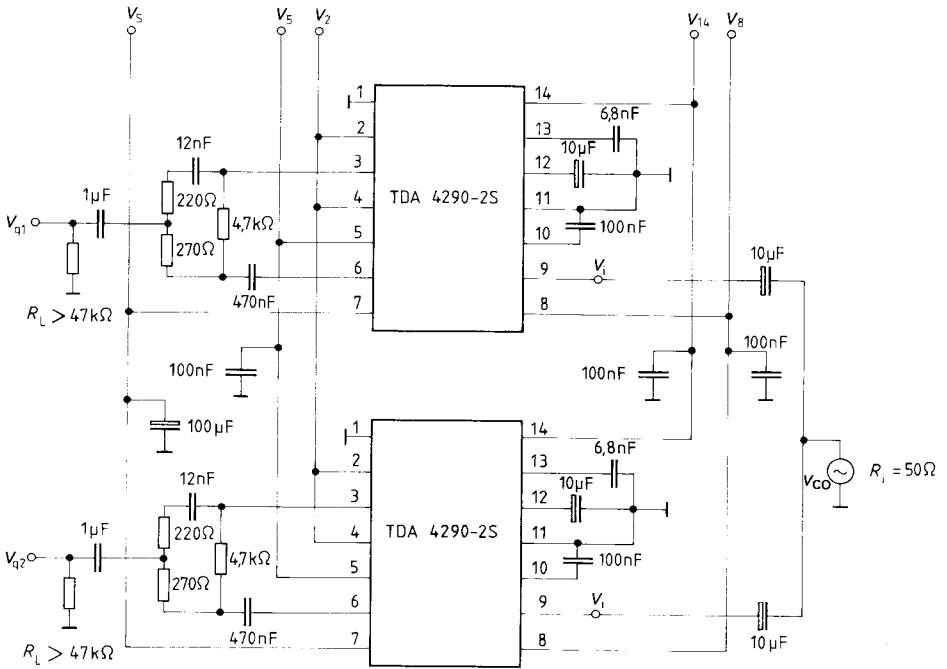

**Physiological volume characteristic**  
(treble and bass control in linear position)  
 $V_{rms} = 300 \text{ mV}$ ,  $f_i = 1.6 \text{ kHz}$

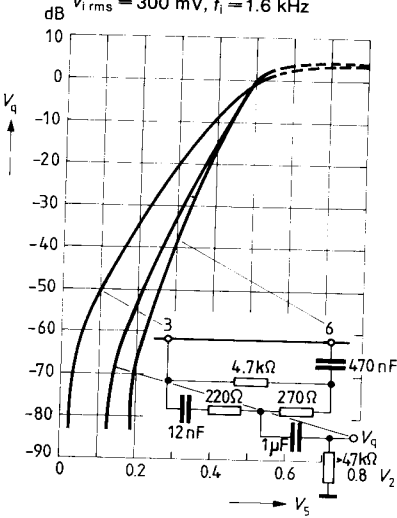

**Treble control**

S1 open;  $V_{rms} = 300 \text{ mV}$ ; volume = 0 dB  
 $f_i = 20 \text{ kHz}$

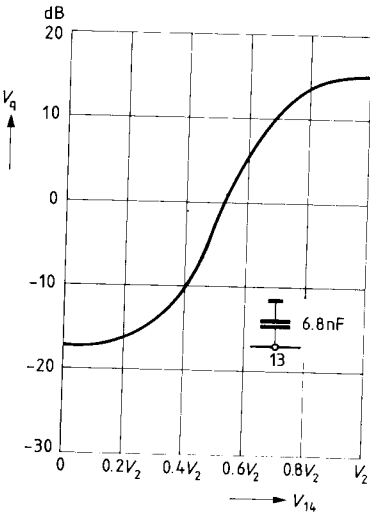

**Bass control**

S1 open;  $V_{rms} = 300 \text{ mV}$ ; volume = 0 dB  
 $f_i = 20 \text{ Hz}$

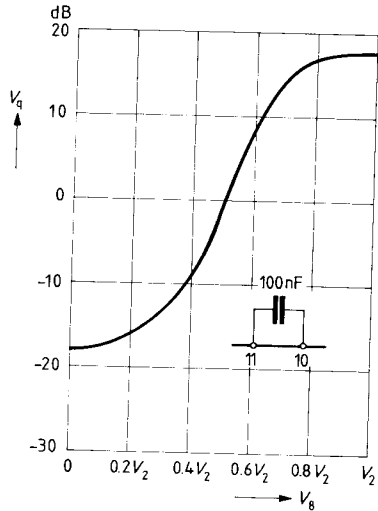

**Bass and treble control**

$V_{i,rms} = 300\text{ mV} \triangleq 0\text{ dB}$ ; S1 open

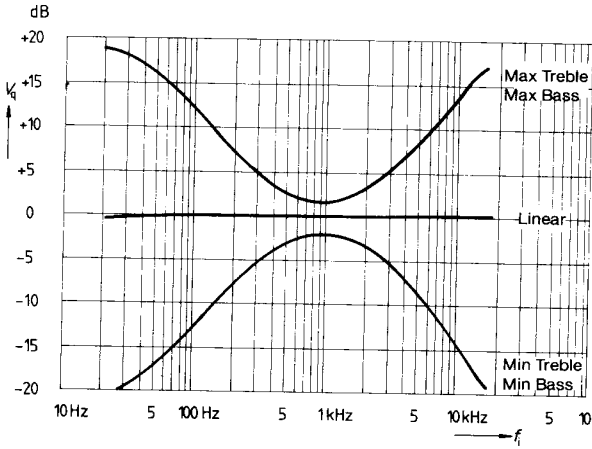

**Bass and treble control**

$V_{i,rms} = 300\text{ mV} \triangleq 0\text{ dB}$ ; S1 open

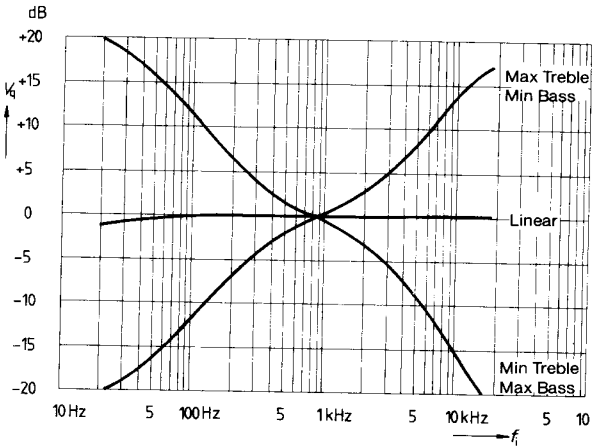

**Physiological volume versus input frequency**

S1 closed;  $V_{rms} = 300 \text{ mV} \pm 0 \text{ dB}$

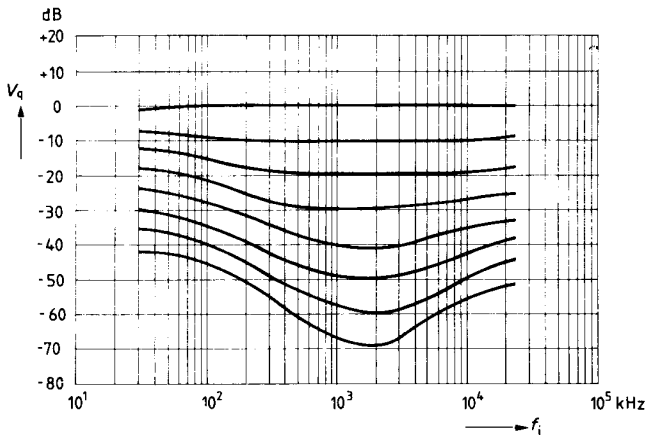

**Disturbance voltage spacing**

Bandwidth 30 Hz to 20 kHz;  $V_{rms} = 300 \text{ V} \pm 0 \text{ dB}$ ;  $f_i = 1 \text{ kHz}$

S1 open; treble and bass control in linear position

