



CAR RADIO DIAGNOSTIC PROCESSOR

PRELIMINARY DATA

- WIDE OPERATING VOLTAGE RANGE
- ST-BY FUNCTION (C-MOS)
- LOW QUIESCENT ST-BY CURRENT CONSUMPTION
- I2C BUS INTERFACE WITH 2 EXTERNALLY SELECTABLE ADDRESSES
- UP TO 5 BTL EQUIVALENT INPUTS FOR FAULT DETECTION IN THE AUDIO CHANNELS
 - short to GND
 - short to V_s
 - short across the load (at turn-on)
 - open load (at turn-on)
- 2 AUX INPUTS FOR FAULT DETECTION IN THE ANTENNA AND BOOSTERS SUPPLY LINE
 - short to GND
 - open load
- WARNING PIN FUNCTION (interrupt facility) ACTIVATED IN THE FOLLOWING CONDITION:
 - audio channel shorted to V_s
 - audio channel shorted to GND
 - aux input shorted to GND
- NOISE FREE DIAGNOSTICS OPERATION

PROTECTORS

- LOAD DUMP VOLTAGE

PIN CONNECTION (Top view)

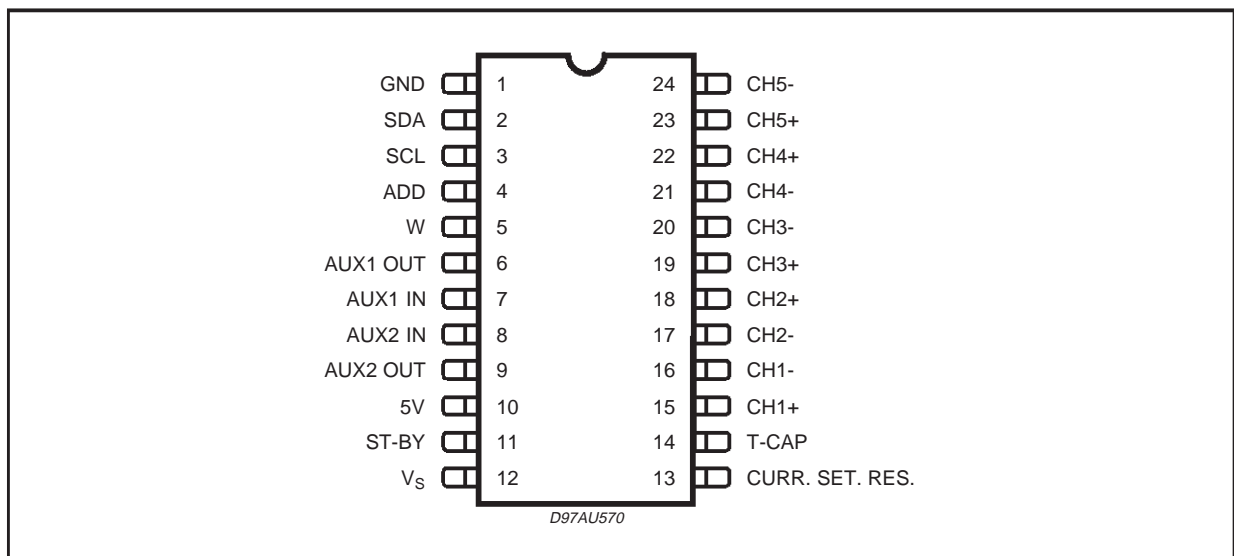

MULTIPOWER BCD TECHNOLOGY

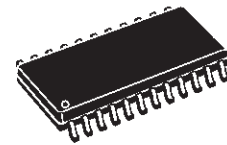

SO24

- OPEN GND
- REVERSED BATTERY
- ESD

DESCRIPTION

The car radio diagnostic processor is an interface chip in BCD Technology intended for car radio applications. It is able to detect potential faults coming from any misconnection in the car radio or in the harness when installing the set.

The device is able to reveal any fault in the loud-speaker lines and in the antenna and booster supply lines, providing a proper output signal (I²C bus compatible) in order to disable the ICs under fault and/or to alert μ controller by means of warning messages.

BLOCK DIAGRAM

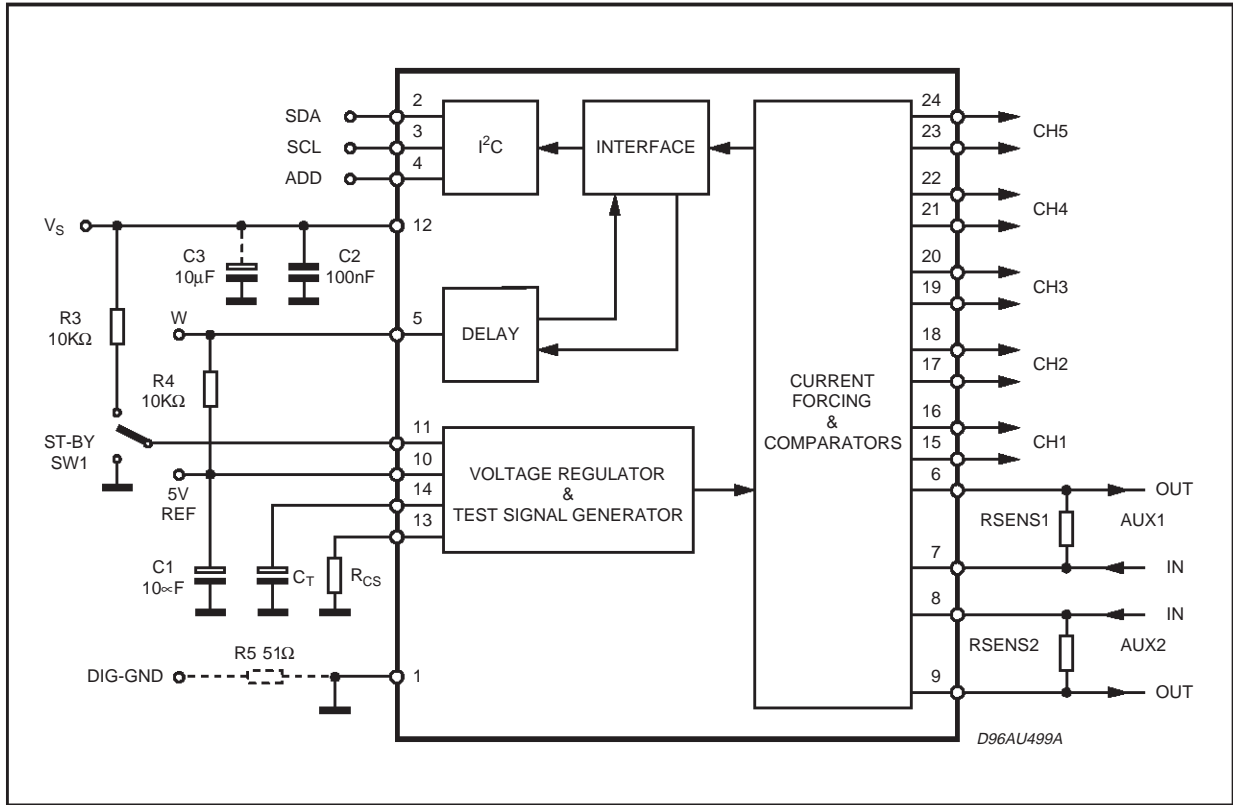

ABSOLUTE MAXIMUM RATINGS

Symbol	Parameter	Value	Unit
V_{op}	Operating Supply Voltage	18	V
V_s	DC Supply Voltage	28	V
V_{peak}	Peak Supply Voltage $t = 50ms$	40	V
P_{tot}	Total Power Dissipation $T_{case} = 25^{\circ}C$	1.5	W
$T_{stg}; T_j$	Storage and Junction Temperature	-40 to 150	$^{\circ}C$
V_{SB}	Stand-by Pin Voltage	6	V
V_{SDA}	SDA Pin Voltage	6	V
V_{SCL}	SCL Pin Voltage	6	V
V_{ADD}	ADD Pin Voltage	6	V

THERMAL DATA

Symbol	Parameter	Value	Unit
$R_{Th-j-amb}$	Thermal resistance junction to ambient	Max. 85	$^{\circ}C/W$

ELECTRICAL CHARACTERISTICS ($V_s = 14.4V; T_{amb} = 25^{\circ}; R_L = 4\Omega$, unless otherwise specified.)

Symbol	Parameter	Test Condition	Min.	Typ.	Max.	Unit
V_{SBIN}	Stand-By IN Threshold				1.5	V
V_{SBOUT}	Stand-By OUT Threshold		3.5			V
I_{SB}	Stand-By Current Consumption	Stand-By Voltage Pin = 1.5V			100	μA
I_q	Total Quiescent Current	Total quiescent Current with TDA7476 not addressed		5		mA

ELECTRICAL CHARACTERISTICS (continued)

Symbol	Parameter	Test Condition	Min.	Typ.	Max.	Unit
AUDIO INPUTS CH1, CH2, CH3, CH4, CH5 - TURN ON DIAGNOSTIC						
Pgnd	Short to GND det. (below this limit, the Audio Output is considered in Short Circuit to GND)	Power amplifier in st-by condition			0.8	V
Pvs	Short to Vs det. (above this limit, the Audio Output is considered in Short Circuit to Vs)		Vs-0.7			V
Pnop	Normal operation thresholds. (Within these limits, the Audio Output is considered without faults)		1.2		Vs-1.3	V
Lsc	Shorted Load det. (voltage across the Audio Outputs). Below this limit the load is considered shorted.				5	mV
Lop	Open Load det. (voltage across the Audio Outputs). Above this limit the load is considered open.		550			mV
Lnop	Normal load det. (Voltage across the Audio Output). Within these limits the load resistance is considered normal.		22		220	mV
AUX INPUTS AUX1, AUX2 - TURN ON DIAGNOSTIC						
Agnd	Short to GND det. (voltage across the sensing resistor). Above this limit the AUX pin is considered in Short Circuit to GND.	High side driver ON	0.75			V
Aol	Open load det. (voltage across the sensing resistor). Below this limit the Aux pin is considered in Open Load condition.				0.085	V
Anop	Normal Operation det. (Voltage across the sensing resistor). Within these limits the load resistance connected to the Aux pin is considered correct.		0.125		0.5	V
AUDIO INPUTS - PERMANENT DIAGNOSTIC						
Pgnd	Short to GND det. (below this limit, the Audio Output is considered in Short Circuit to Vs) This condition must be true for a time higher than Tdel	Power amplifier ON			0.8	V
Pvs	Short to Vs det. (above this limit the Audio Output is considered in Short Circuit to Vs) This condition must be true for a time higher than Tdel		Vs-0.7			V
Pnop	Normal operation thresholds. (Within these limits, the Audio Output is considered without faults)		1.2		Vs-1.3	V

ELECTRICAL CHARACTERISTICS (continued)

Symbol	Parameter	Test Condition	Min.	Typ.	Max.	Unit
AUX INPUTS - PERMANENT DIAGNOSTIC						
Agnd	Short to GND det. (above this limit, the Audio Output is considered in Short Circuit to Vs) This condition must be true for a time higher than Tdel	High side driver ON	0.75			V
Aol	Open load det. (voltage across the sensing resistor. Below this limit the Aux pin is considered in Open Load condition) This condition must be true for a time higher than Tdel				0.085	V
Anop	Normal Operation det. (Voltage across the sensing resistor. Within these limits the load resistance connected to the Aux pin is considered correct)		0.125		0.5	V
PERMANENT DIAGNOSTIC - ACQUISITION TIME DELAY						
Tdel	Acquisition time delay - The fault is considered true if the fault condition are present for more than Tdel without interruption			2		s
PERMANENT DIAGNOSTIC - WARNING PIN						
Vsat	Saturation voltage on pin 5	Sink Current at Pin 5 = 1mA			1	V
ADDRESS SELECT						
VADD	Voltage on pin 4	Address 0100010X			1.5	V
		Address 0100011X	3		5	V
I²C BUS INTERFACE						
fSCL	Clock Frequency				400	KHz
VIL	Input Low Voltage				1.5	V
VIH	InputHigh Voltage		3			V
VSAT	Sat Voltage at pin 2	Sink Current at Pin 2 = 5mA			1.5	V

WORKING PRINCIPLES

Turn-on diagnostic - CH1, CH2, CH3, CH4, CH5 - Shorted load/open load detection

- To detect a short across the load or an open load, a subsonic current pulse is generated. The information related to the status of the outputs are measured and memorized at the top of the current pulse (tm in fig.1). The current is sourced by the positive pins (CH1+,...CH5+) and it is sunk by the corresponding negative pins (CH1-,...CH5-).

Figure 1.

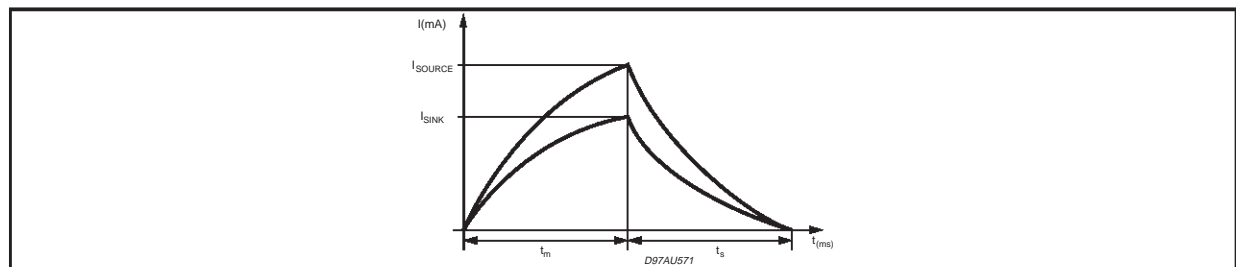

- **Isink** and **Isource** are depending on the external resistor **Rcs**. The minimum allowed value for **Rcs** is 1.65KOhm. The relationship among **Isink**, **Isource** and **Rcs** is the following:

$$Isink = (3.3/Rcs) \times 11$$

$$Isource = 1.5 \times Isink$$

- On **bridge** (or bridge equivalent) devices if there is no short circuit to GND or to V_s , I_{source} goes into saturation mode (for $V_{out} > 3V$), and in the load flows I_{sink} . As the turn-on diagnostic thresholds are fixed, it is possible to calculate the ranges of loudspeaker resistance in which short circuit, normal operation and open load are detected.

For example, here below are two cases, with $R_{cs} = 3.3k\Omega$ and $R_{cs} = 1.8k\Omega$. ($R_L = V_{thr}^*/I_{sink}$).

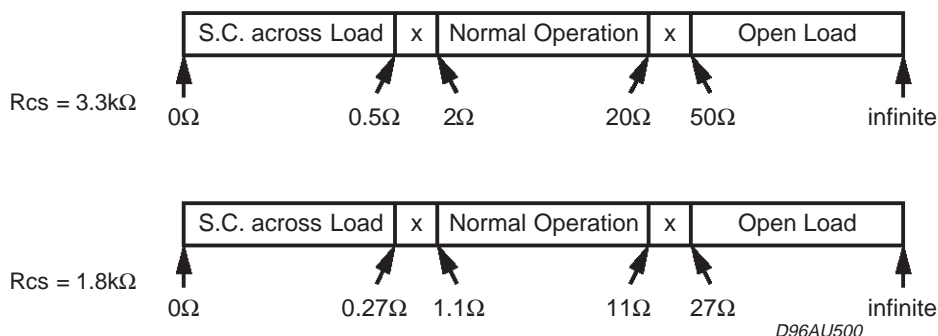

- The exact values of the above mentioned resistive ranges may vary a little, depending on the power amplifier used. These values for the various possible ST power amplifiers will be communicated later.
- When single-ended devices are used and the application circuit is as shown in fig. 5,6, it is necessary to use:
 - a greater timing capacitor so that the time t_m is high and the outputs of the amplifiers are able to rise over 1V;
 - a resistor R_{cs} 1.5 times higher than that used for the bridge amplifiers.
- In this case, the loudspeaker resistance ranges in which short circuit, normal operation and open load are detected will be as follows with $R_{cs} = 4.7k\Omega$ and $R_{cs} = 2.7k\Omega$ ($R_L = V_{thr}/I_{source}$)

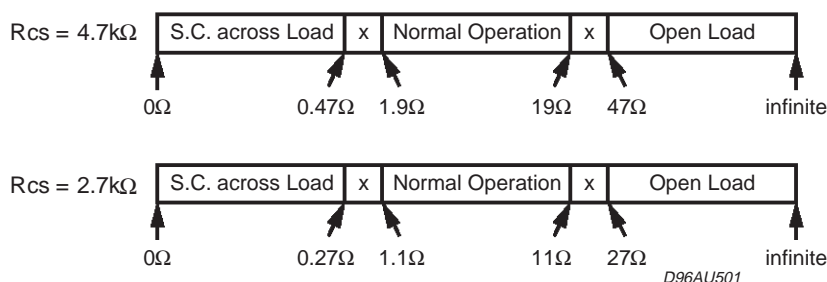

- The exact values of the above mentioned resistive ranges may vary a little, depending on the power amplifier used. These values will be communicated later.

Turn-on diagnostic - CH1, CH2, CH3, CH4, CH5 - Short to GND and V_s .

To detect if there is short circuit to GND or V_s , the subsonic current pulse is exploited. The information related to the status of the outputs are measured and memorized at the top of the current pulse (t_m in fig.1). If no faults are present, the pins connected to the audio outputs (CH1,..CH5) will reach about 3V.

If one or more outputs are shorted to GND, these voltages become lower than 3V.

If one or more outputs are shorted to V_s , the output voltage increases over 3V.

The fault status can be know by sensing the output voltages. The reason way voltage threshold has been preferred instead of a current threshold to declare short circuit resistor ranges is two fold:

- The amplifier can drain current in the resistive path of the short circuit, hence this current and consequently the short circuit resistor cannot be determined with a sufficient level of accuracy.
- The voltage difference between the car radio ground (reference) and the position of the chassis of the car where the loudspeaker line is connected (due to an accidental short circuit) can be up to some hundreds of mV. This does not permit a correct measure of the short circuit resistor.

(*) V_{thr} is the threshold described in the table on page 3/14 - 4/14 (for example $P_{gnd-min}$, P_{vs-max} , $P_{nop-min}$, $P_{nop-max}$ etc..)

Turn-on diagnostic - AUX1, AUX2

- To detect if there is a short circuit to GND or an open load involving to the AUX output of the car radio, the voltage across a sensing resistor Rsens is detected. These output voltages (for example for the active antenna and for the booster) are usually generated by high side drivers, but also voltage regulators with Vout > 5V are admissible. The detection ranges can be set by adjusting the sensing resistors Rsens1 or Rsens2. For example, if Rsens = 50hm, the following detection table will be operative (I = Vthr/Rsens):

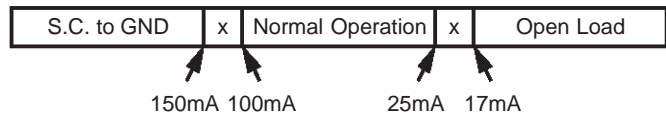

Permanent diagnostic - CH1, CH2, CH3, CH4, CH5 - Short to GND and Vs

- During the CAR-RADIO normal operation, to detect a short circuit to GND (or to Vs), the output voltages are sensed. If one or more outputs stay at any voltage below 0.8V or over Vs-0.8V for more than 2 sec. (typ), the warning pin is pulled down. The μP can address the TDA7476 to know the status. The subsonic current pulse is activated also in this case. The fault is correctly detected if it remains until the memorization (tm in fig.1). In this phase, faults regarding shorts across the load and open loads cannot be detected. For single-ended devices as in fig. 5, 6 a short circuit to ground is detected both when a short to ground is really present and when the load is missing.

Permanent diagnostic - AUX1, AUX2 - Short circuit to GND and open load

- The detection mode of the auxiliary inputs is equal to what is in place during turn-on, but the fault must be lasting without interruption for more than 2 seconds. The warning pin is pulled down only in case of short to GND. This is to avoid that this pin remains permanently to 0 level if one or both AUX outputs of the car radio are unused.

Timing

- From the byte "ADD1" to the byte "ADD2" the μP must wait a period Twait1 (see Software Specification) that is depending on the timing capacitor CT according to the following table (Twait1 > tm, max):

CT (μF)	tm max (ms)
3.3	45
4.7	65
10	130
22	290
47	620
100	1300

Note: any (positive) spread of the capacitor value must be added. The relation to be used to determine Twait1 from the value of CT according to the following:

$$Twait1 > tm, max = (130 \times CT / 10\mu F)ms$$

- After the byte "ADD2" the power amplifier can be switched-on. In some cases, the μP has to wait until the current pulse is finished (Twait2). This time (ts in fig.1) is given by:

$$Twait2 > ts, max = (140 \times CT / 10\mu F)ms$$

For bridge or bridge equivalent devices (figg.7,8), Cs = 10μF will be enough.

For the TDA7375, connected as in fig.5, Cs = 47μF if Cout = 1000μF, and Cs = 100μF if Cout = 2200μF.

If the circuit is as shown by fig. 6, the suggested values of Cs are as follows: Cs = 22μF if Cout = 1000μF, Cs = 47μF if Cout = 2200μF.

TURN-ON DIAGNOSTIC - THRESHOLDS**CH1, CH2, CH3, CH4, CH5**

- Output voltage during test. (The power amplifier must be in ST-BY mode).

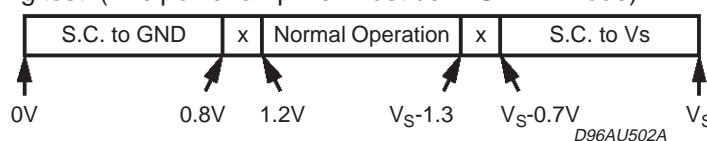

- Voltage across the load during test. (The power amplifier must be in ST-BY mode).

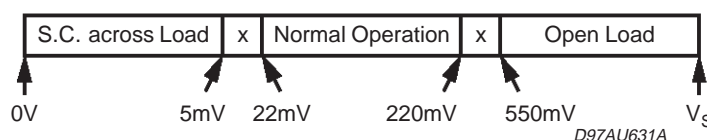

- Note: some faults can mask others if they are present at the same moment on the same channel:
 - If there is a short to GND and an open load on the same channel, the TDA7476 gives information only about one of them, depending on the wire on which the short circuit is present.
 - The short circuit to GND masks any short circuit across the load.
 - The short circuit to Vs masks any short or open load.

AUX1 - AUX2

- Voltage across the sensing resistors.

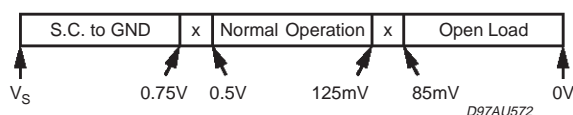

- The minimum voltage of the AUX IN pin to sense the open load condition is 2V.
- The minimum voltage of the AUX IN pin to detect the short circuit to GND, by sensing the drop on the resistors is 4.5V. If this voltage falls below 2V, the AUX in is considered short circuited to GND. From 2V to 4.5V the sensing circuit can detect a short circuit in both ways (by sensing across the resistor or through the voltage between the AUX IN pin and GND).

PERMANENT DIAGNOSTIC - THRESHOLDS**CH1, CH2, CH3, CH4, CH5**

- The circuit will recognize as a fault condition any situation where the following short circuit voltages last more than 2 sec (typ).
- Output voltage

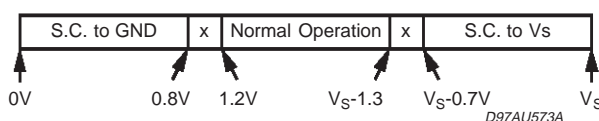
**AUX1 - AUX2**

- The voltage across the resistors Rsens1 or Rsens2 is sensed. The circuit will recognize as a fault condition any situation where the following voltages last more than 2sec (typ) in the region "S.C.to GND" or "open load".

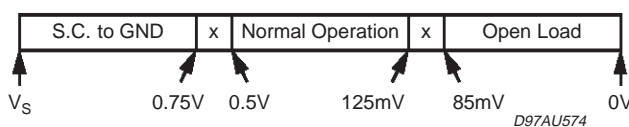

- The minimum voltage of the AUX IN pins to sense the open load condition is 2V.
- The minimum voltage of the AUX IN pin to detect the short circuit to GND by sensing drop on the resistor is 4.5V. If this voltage is below 2V, the AUX line is considered short circuited to GND. From 2V to 4.5V the sensing circuit can detect a short circuit in both ways (by sensing across the resistor or through the voltage between the AUX IN pin and GND).

I²C BUS INTERFACE

Data transmission from microprocessor to the TDA7476 and viceversa takes place through the 2 wires I²C BUS interface, consisting of the two lines SDA and SCL (pull-up resistors to positive supply voltage must be connected).

Data Validity

As shown by fig. 2, the data on the SDA line must be stable during the high period of the clock. The HIGH and LOW state of the data line can only change when the clock signal on the SCL line is LOW.

Start and Stop Conditions

As shown by fig. 3 a start condition is a HIGH to LOW transition of the SDA line while SCL is HIGH. The stop condition is a LOW to HIGH transition of the SDA line while SCL is HIGH.

Byte Format

Every byte transferred to the SDA line must contain 8 bits. Each byte must be followed by an acknowledge bit. The MSB is transferred first.

Acknowledge

The transmitter* puts a resistive HIGH level on the SDA line during the acknowledge clock pulse (see fig.4). The receiver** the acknowledges has to pull-down (LOW) the SDA line during the acknowledge clock pulse, so that the SDAline is stable LOW during this clock pulse.

* Transmitter

- = master (μP) when it writes an address to the TDA7476
- = slave (TDA7476) when the μP reads a data byte from TDA7476

** Receiver

- = slave (TDA7476) when the μP writes an address to the TDA7476
- = master (μP) when it reads a data byte from TDA7476

Figure 2: Data Validity on the I²CBUS

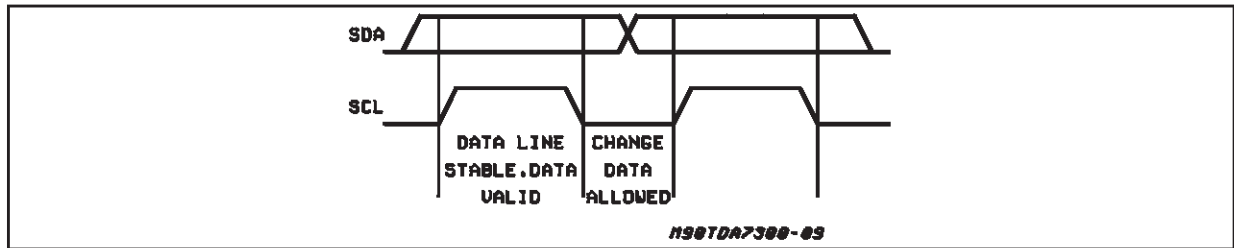

Figure 3: Timing Diagram on the I²CBUS

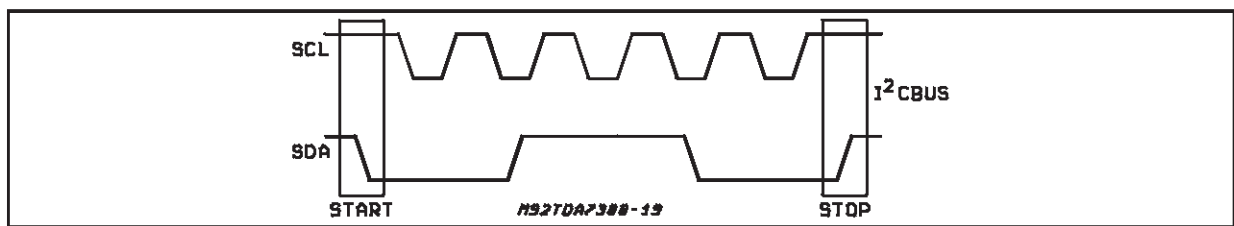
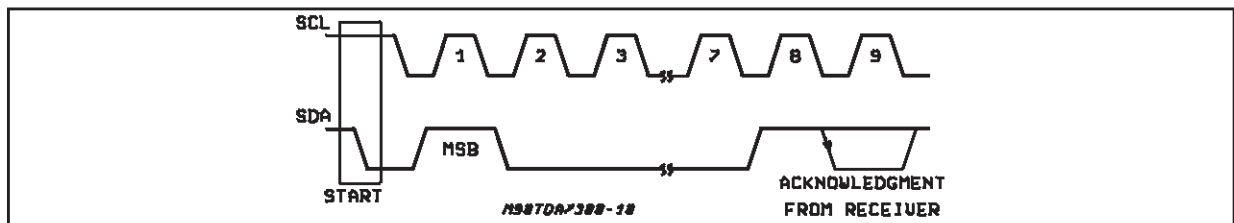

Figure 4: Acknowledge on the I²CBUS



SOFTWARE SPECIFICATIONS

The TDA7476 is activated by turning-on the ST-BY pin (CMOS compatible). In this condition it waits for the I²C Bus addressing byte **ADD1** (WRITE to TDA7476)

ADD1				
S	010001A	0	ACK	P

This sequence (where the bit 0 of ADD1 is at 0 level) enables the acquisition routine and starts the single pulse (containing infrasonic harmonics) for the test. During this period the data regarding all the outputs are memorized.

After a period Twait1 that depends on the value of the timing capacitor (see **Timing**) the μ P redirects the TDA7476 by the byte **ADD2**.

ADD2										
S	010001A	1	ACK	BYTE 1	ACK	BYTE 2	ACK	BYTE 3	ACK	STOP

The byte ADD2 contains the bit 0 at 1 level. This enables the reading mode, TDA7476's. The 3 bytes with the diagnostic information **BYTE1, BYTE2, BYTE3** (READ FROM TDA7476) are now transmitted to the μ P.

The address of TDA7476 is selected using pin ADD (pin 4) .

If ADD is connected to ground, then A = 0 and the TDA7476 address is 0100010X.

If ADD is connected to 5V, than A = 1 and the TDA7476 address is 0100011X

- The TDA7476 provides two types of diagnostic information:

A) TURN-ON DIAGNOSTIC - The first time that the TDA7476 is addressed by I²C Bus, the more complete set of diagnostic information is activated:

- **CH1, CH2, CH3, CH4, CH5**

Short Circuit to GND

Short Circuit to Vs

Open Load (*)

Short Circuit across the load (*)

(*) Detected if the power amplifiers are in ST-BY condition.

- **AUX1, AUX2**

Short Circuit to GND (*)

Open Load (*)

(*) Detected if the high side drivers attached to the Aux outputs are ON.

Here following the turn-on diagnostic output bytes

TDA7476

READ BYTE 1

MSB				LSB				STATUS
D7	D6	D5	D4	D3	D2	D1	D0	
X	X	X	X	1	1	X	0	CH1 short circuit to Vs
X	X	X	X	1	1	0	X	CH1 short circuit to GND
X	X	X	X	1	0	1	1	CH1 open load
X	X	X	X	0	1	1	1	CH1 short circuit across the load
1	1	X	0	X	X	X	X	CH2 short circuit to Vs
1	1	0	X	X	X	X	X	CH2 short circuit to GND
1	0	1	1	X	X	X	X	CH2 open load
0	1	1	1	X	X	X	X	CH2 short circuit across the load

READ BYTE 2

X	X	X	X	1	1	X	0	CH3 short circuit to Vs
X	X	X	X	1	1	0	X	CH3 short circuit to GND
X	X	X	X	1	0	1	1	CH3 open load
X	X	X	X	0	1	1	1	CH3 short circuit across the load
1	1	X	0	X	X	X	X	CH4 short circuit to Vs
1	1	0	X	X	X	X	X	CH4 short circuit to GND
1	0	1	1	X	X	X	X	CH4 open load
0	1	1	1	X	X	X	X	CH4 short circuit across the load

READ BYTE 3

X	X	X	X	X	X	1	0	AUX1 short circuit to GND
X	X	X	X	X	X	0	1	AUX1 open load
X	X	X	X	1	0	X	X	AUX2 short circuit to GND
X	X	X	X	0	1	X	X	AUX2 open load
1	1	X	0	X	X	X	X	CH5 short circuit to Vs
1	1	0	X	X	X	X	X	CH5 short circuit to GND
1	0	1	1	X	X	X	X	CH5 open load
0	1	1	1	X	X	X	X	CH5 short circuit across the load

When the μ P reads correctly all the 3 bytes containing the mentioned information and gives the last acknowledgment, the TDA7476 switches to the "permanent diagnostic operation"

B) PERMANENT DIAGNOSTIC

It can sense the following diagnostic information:

CH1, CH2, CH3, CH4, CH5

- Short Circuit to GND

- Short Circuit to Vs

Aux1, Aux2

- Short Circuit to GND (*)

- Open Load (*)

(*) Detected if the high side drivers attached to the Aux outputs are ON.

In this case the above conditions are not detected while the single infrasonic current pulse is present but before. The fault condition must be present for more than 2sec. (typ) and must be also true during the pulse, where the data are memorized and then transmitted.

The bytes from/to μ P and TDA7476 are the same as those in case of turn-on diagnostic (see above).

Here following is the permanent diagnostic output Data Bytes. The bits D7 and D6 of the first byte both stand at 0 level. This condition, although not possible during the turn-on diagnostic, can be useful to confirm that the bytes are referred to the permanent diagnostic.

READ BYTE 1

MSB				LSB				STATUS
D7	D6	D5	D4	D3	D2	D1	D0	
0	0	X	X	1	1	X	0	CH1 short circuit to Vs
0	0	X	X	1	1	0	X	CH1 short circuit to GND
0	0	X	X	1	1	1	1	
0	0	X	X	1	1	1	1	
0	0	X	0	1	1	X	X	CH2 short circuit to Vs
0	0	0	X	1	1	X	X	CH2 short circuit to GND
0	0	1	1	1	1	X	X	
0	0	1	1	1	1	X	X	

READ BYTE 2

1	1	X	X	1	1	X	0	CH3 short circuit to Vs
1	1	X	X	1	1	0	X	CH3 short circuit to GND
1	1	X	X	1	1	1	1	
1	1	X	X	1	1	1	1	
1	1	X	0	1	1	X	X	CH4 short circuit to Vs
1	1	0	X	1	1	X	X	CH4 short circuit to GND
1	1	1	1	1	1	X	X	
1	1	1	1	1	1	X	X	

READ BYTE 3

1	1	X	X	X	X	1	0	AUX1 short circuit to GND
1	1	X	X	X	X	0	1	AUX1 open load
1	1	X	X	1	0	X	X	AUX2 short circuit to GND
1	1	X	X	0	1	X	X	AUX2 open load
1	1	X	0	X	X	X	X	CH5 short circuit to Vs
1	1	0	X	X	X	X	X	CH5 short circuit to GND
1	1	1	1	X	X	X	X	
1	1	1	1	X	X	X	X	

Repetitive turn-on diagnostic

During the turn-on diagnostic, the TDA7476 can reveal false "short circuit across load" and/or false "open load" due to noise sources such as door slams.

This problem can be solved doing more than one turn-on diagnostic routine. If the μ P asks for N times the state of the audio system, it has to consider a fault as really present only if it is detected in all the N turn-on diagnostic.

As above explained, the first time the TDA7476 receives the byte ADD1, it does the turn-on diagnostic; then each time it is addressed with ADD1, it does the permanent diagnostic. This is not true if, when the μ P sends for the first time the byte ADD2, it does not send to the TDA7476 the acknowledge after it has received the byte BYTE3. In this case, the TDA7476 does not switch from turn-on to permanent diagnostic mode so if it receives again the byte ADD1 it works as it was the first time that it does the turn-on diagnostic. In order to do repetitive turn-on diagnostic, the μ P has to be programmed as following:

- Step 1: the μ P sends ADD1

START	ADD1	<u>ACK</u>	STOP
-------	------	------------	------

- Step 2: the μ P waits Twait1 seconds
- Step 3: the μ P sends ADD2, receives BYTE1, BYTE2, BYTE3, **does not send the acknowledge after BYTE3**

START	ADD2	<u>ACK</u>	<u>BYTE1</u>	ACK	<u>BYTE2</u>	ACK	<u>BYTE3</u>	STOP
-------	------	------------	--------------	-----	--------------	-----	--------------	------

- Step 4: repeat Step1, Step2, Step3 while the second, third, fourth, ...turn-on diagnostic has to be done.

During **the last turn-on diagnostic** the μ P sends ADD2, receives BYTE1, BYTE2, BYTE3, and **sends the acknowledge after BYTE3**

START	ADD2	<u>ACK</u>	<u>BYTE1</u>	ACK	<u>BYTE2</u>	ACK	<u>BYTE3</u>	ACK	STOP
-------	------	------------	--------------	-----	--------------	-----	--------------	-----	------

TDA7476

In this way only after that the TDA7476 has done for N times the turn-on diagnostic, it switches from turn-on to permanent diagnostic mode.

From now the TDA7476 always does the permanent diagnostic.

To save time when the audio system is switched on, it is possible to do the repetitive turn-on diagnostic when the car-radio is turned off. In this case the steps to follow to do the repetitive turn-on diagnostic are the following:

- 1- to switch off the TDA7476 connecting STBY pin to ground;
- 2- to wait T_{5V} seconds (time necessary for the discharge of the capacitor). If $C_{5V} = 10\mu\text{F}$ then $T_{5V} = 20\text{ms typ}$;
- 3- to switch on the TDA7476
- 4- to do the repetitive turn-on diagnostic as above described;
- 5- to turn off the TDA7476.

WARNING PIN

- This is an open drain output pin that is activated when a fault condition is present for more than 2 sec (TYP). The fault conditions related to the warning pin are as follows:
 - AUX1, AUX2
Short to GND
 - CH1, CH2, CH3, CH4, CH5:
Short Circuit to GND
Short Circuit to V_s
- The purpose of this pin is to alert the μP and start with the permanent diagnostic routine only if faults are present, thus avoiding CPU's waste of time.

APPLICATION NOTES

- On single-ended devices as in figure 6, 7 if the loads are present then both in turn-on and in permanent diagnostic the fault present on one channel is pointed out for all the loads connected together.
For example:
 - see fig.6 if CH1+ is shorted to ground, the TDA7476 reveals a short to ground both for CH2 and for CH1.
 - see fig.7 if CH1+ is shorted to ground, the TDA7476 detects a short circuit to ground for CH1, CH2, CH3, CH4.
- To use the TDA7476 with a car-radio system which has less than five audio channel and less than two auxiliary loads, it is necessary to take some cares:
 - If the loads are 4Ω speakers ($R_{cs} = 3.3\text{ K}\Omega$), $R \cong 10\Omega$ has to be connected between CH+ and CH- of each channel (see figg. 5,6,7,8 concerning CH5). $R \cong 5\Omega$ has to be used if loads are 2Ω speakers ($R_{cs} = 1.8\text{ K}\Omega$).
 - If AUX1/AUX2 are unused, Rsens1/Rsens2 will not be needed. The AUX-IN pin(s) can be tied to the 5 internal regulator (pin 10) while setting the AUX-OUT pin(s) about 250mV lower than AUX-IN's (admissible range = 125mV to 500mV). This can easily be obtained by means of a voltage divider. If both the AUX channels are unused, pins 7-8 (AUX-INS) and pins 6-9 (AUX-OUTs) can be respectively connected together, so that a single voltage divider could be used.

The above actions will prevent any "warning" activation which might cause unwanted microprocessor's interrupt.

APPLICATION EXAMPLES WITH ST AUDIO POWER ICs

Figure 5: TDA7375 in S.E. mode with 4 output capacitors

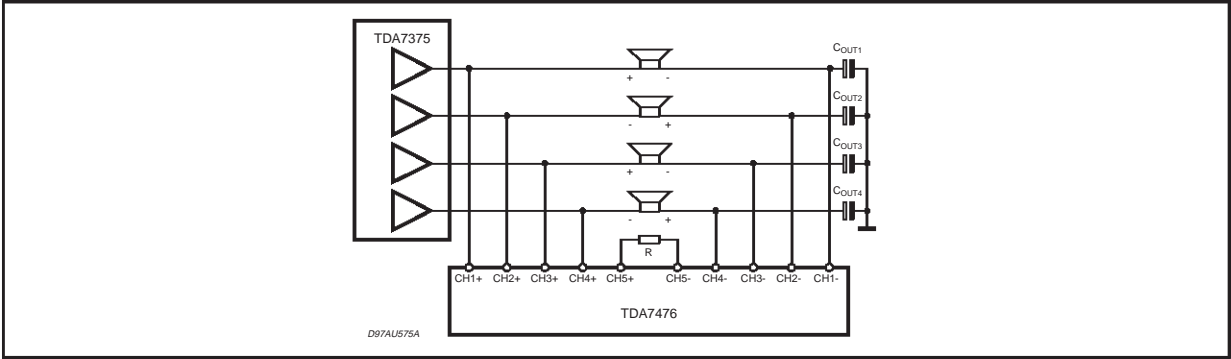

Figure 6: TDA7375 in S.E. mode with 2 output capacitors

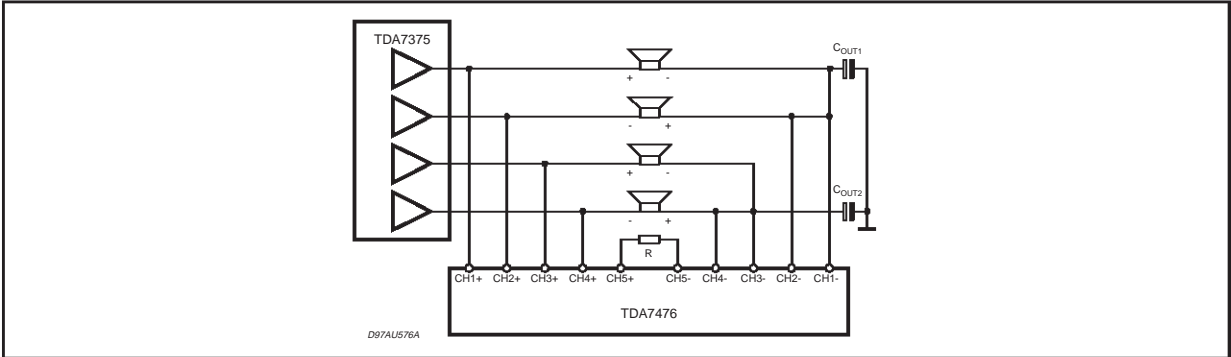

Figure 7: TDA7451

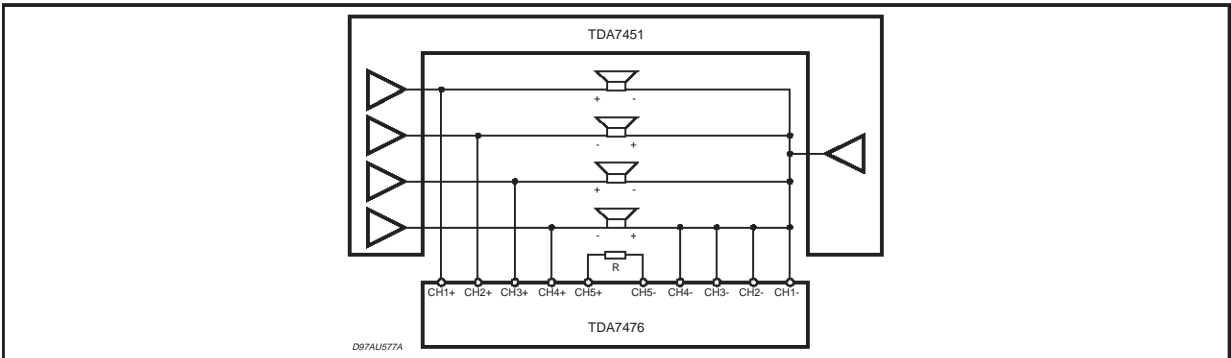
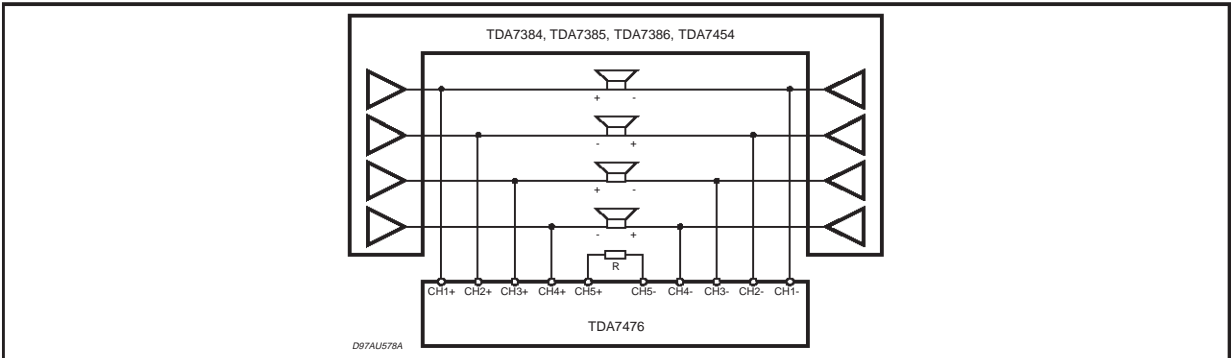

Figure 8: Quad Bridge Amplifiers



TDA7476

DIM.	mm			inch		
	MIN.	TYP.	MAX.	MIN.	TYP.	MAX.
A	2.35		2.65	0.093		0.104
A1	0.10		0.30	0.004		0.012
A2			2.55			0.100
B	0.33		0.51	0.013		0.0200
C	0.23		0.32	0.009		0.013
D	15.20		15.60	0.598		0.614
E	7.40		7.60	0.291		0.299
e		1.27			0,050	
H	10.0		10.65	0.394		0.419
h	0.25		0.75	0.010		0.030
k	0° (min.), 8° (max.)					
L	0.40		1.27	0.016		0.050

OUTLINE AND MECHANICAL DATA

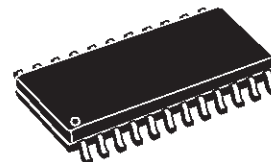

SO24

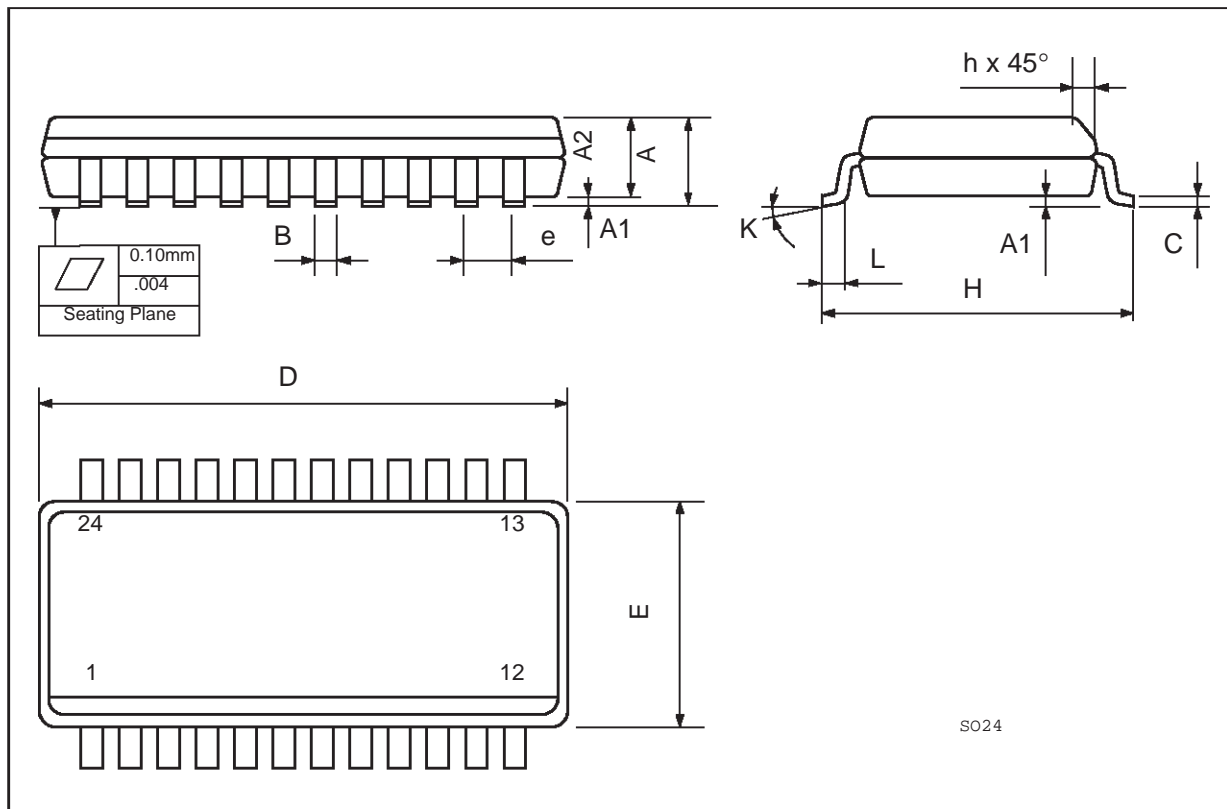

Information furnished is believed to be accurate and reliable. However, STMicroelectronics assumes no responsibility for the consequences of use of such information nor for any infringement of patents or other rights of third parties which may result from its use. No license is granted by implication or otherwise under any patent or patent rights of STMicroelectronics. Specification mentioned in this publication are subject to change without notice. This publication supersedes and replaces all information previously supplied. STMicroelectronics products are not authorized for use as critical components in life support devices or systems without express written approval of STMicroelectronics.

The ST logo is a registered trademark of STMicroelectronics

© 1999 STMicroelectronics – Printed in Italy – All Rights Reserved

STMicroelectronics GROUP OF COMPANIES

Australia - Brazil - China - Finland - France - Germany - Hong Kong - India - Italy - Japan - Malaysia - Malta - Morocco -
Singapore - Spain - Sweden - Switzerland - United Kingdom - U.S.A.

<http://www.st.com>