

TG2210FT

RF SPDT Switch

Switch the receive filter for mobile communication.
 Switch the diversity antenna.
 Switch the local signal.

Features

- Low insertion Loss: LOSS = 0.4dB (typ.)
- High isolation: ISL = 30dB (typ.)
- Low voltage operation: $V_C = 0\text{ V}/2.5\text{ V}$
- Small package: TU6 package (2.0 × 1.25 × 0.6 mm)

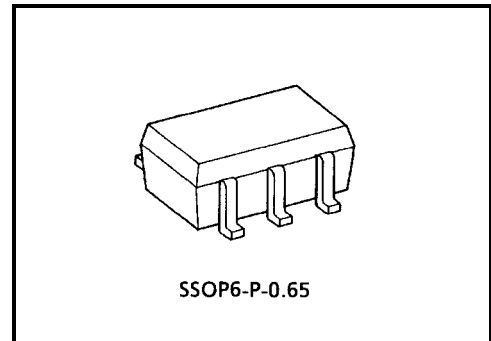

Weight: 0.008 g (typ.)

Pin Connection, Marking (top view)

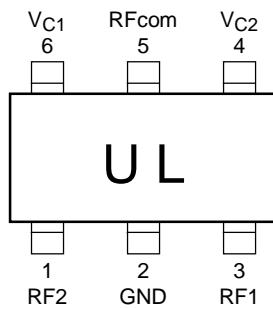

Maximum Ratings (Ta = 25°C)

Characteristics	Symbol	Rating	Unit
Control voltage	V_{C1}	5	V
	V_{C2}	5	V
Input power	P_i	1	W
Operating temperature range	T_{opr}	-40~85	°C
Storage temperature range	T_{stg}	-55~125	°C

Caution

This device is sensitive to electrostatic discharge. When using this device, please ensure that all tools and equipment are earthed.

Electrical Characteristics (f = 1 GHz, Ta = 25°C, Zg = Zl = 50 Ω)

Characteristics	Symbol	Test Circuit	Test Condition	Min	Typ.	Max	Unit
Insertion Loss	LOSS (1)	1	$V_{C1} = 2.5\text{ V}, V_{C2} = 0\text{ V}, P_i = 0\text{ dBmW}$	—	0.4	0.7	dB
	LOSS (2)	1	$V_{C1} = 0\text{ V}, V_{C2} = 2.5\text{ V}, P_i = 0\text{ dBmW}$	—	0.4	0.7	dB
Isolation	ISL (1)	1	$V_{C1} = 2.5\text{ V}, V_{C2} = 0\text{ V}, P_i = 0\text{ dBmW}$	27	30	—	dB
	ISL (2)	1	$V_{C1} = 0\text{ V}, V_{C2} = 2.5\text{ V}, P_i = 0\text{ dBmW}$	27	30	—	dB
Input power at 1dB gain compression	$P_{1\text{dB}}$	1	$V_{C1} = 2.5\text{ V}, V_{C2} = 0\text{ V}$ or $V_{C1} = 0\text{ V}, V_{C2} = 2.5\text{ V}$	18	—	—	dBmW
Control current	I_{C1}	—	$V_{C1} = 0\text{ V}, V_{C2} = 3\text{ V}$ or $V_{C1} = 3\text{ V}, V_{C2} = 0\text{ V}$	—	—	0.01	mA
	I_{C2}	—		—	—	0.01	mA
Switching time	t_{sw}	—	$V_{C1} = 0\text{ V}, V_{C2} = 2.5\text{ V}$ or $V_{C1} = 2.5\text{ V}, V_{C2} = 0\text{ V}$	—	200	—	ns

Block Diagram

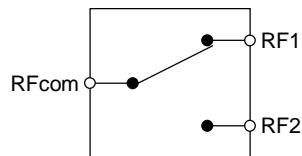

Switch Condition

Control Voltage	Switch Condition
$V_{C1} = 2.5\text{ V}$ $V_{C2} = 0\text{ V}$	RFcom — RF1 OFF RFcom — RF2 ON
$V_{C1} = 0\text{ V}$ $V_{C2} = 2.5\text{ V}$	RFcom — RF1 ON RFcom — RF2 OFF

Test Circuit 1 (RF Test Circuit)

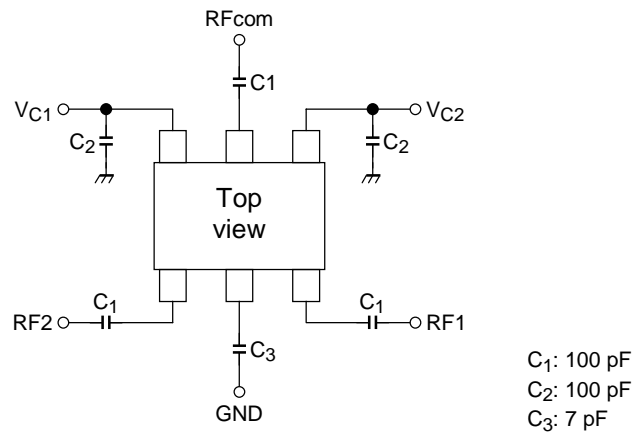

Please fix the value of each capacity for using frequency and circuit.

Recommend Capacity

	1 GHz	1.6 GHz	2.4 GHz
C ₁	100 pF	100 pF	100 pF
C ₂	100 pF	100 pF	100 pF
C ₃	7 pF	3 pF	1.5 pF

Notice

The circuits and measurements contained in this document are given only in the context of as examples of applications for these products.

Moreover, these example application circuits are not intended for mass production, since the high-frequency characteristics (the AC characteristics) of these devices will be affected by the external components which the customer uses, by the design of the circuit and by various other conditions.

It is the responsibility of the customer to design external circuits which correctly implement the intended application, and to check the characteristics of the design.

TOSHIBA assume no responsibility for the integrity of customer circuit designs or applications.

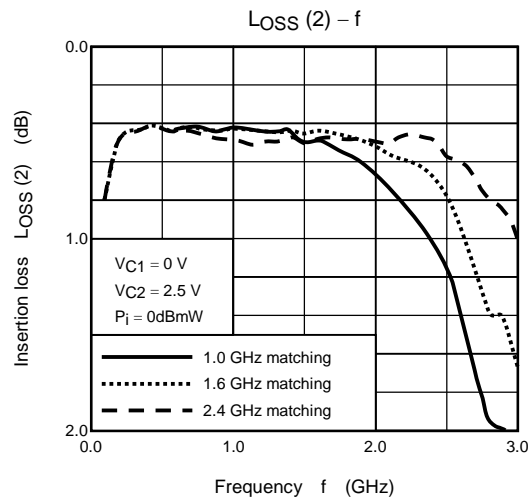
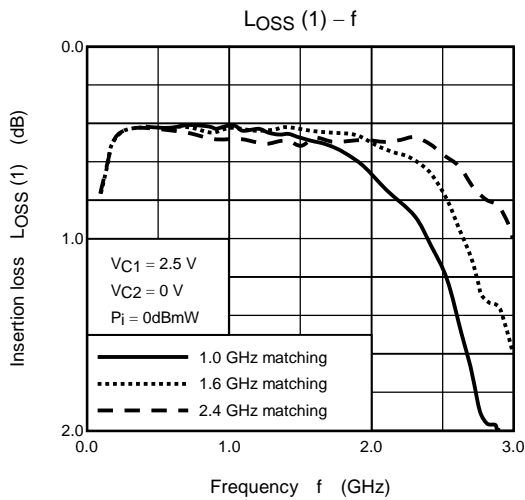
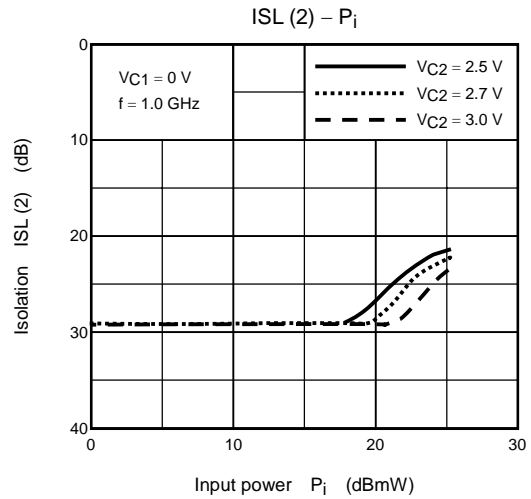
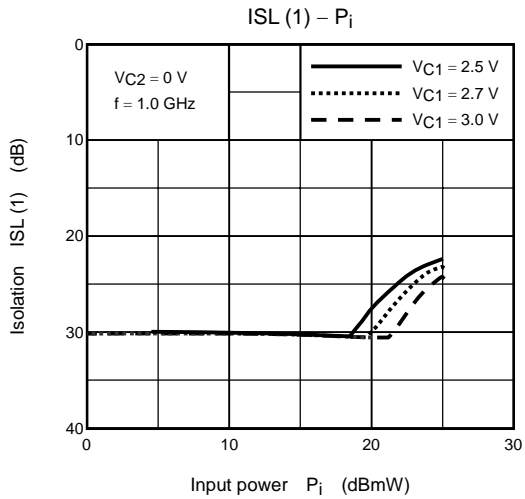
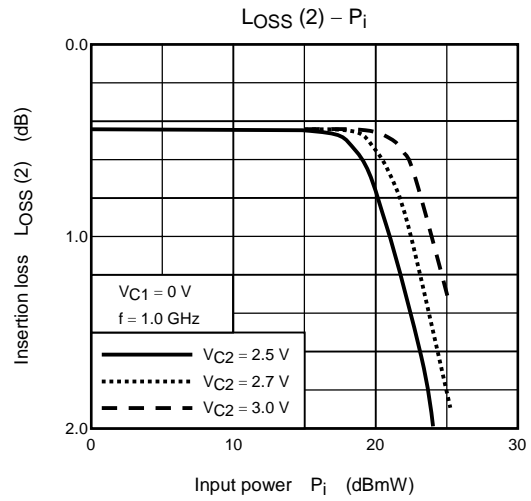
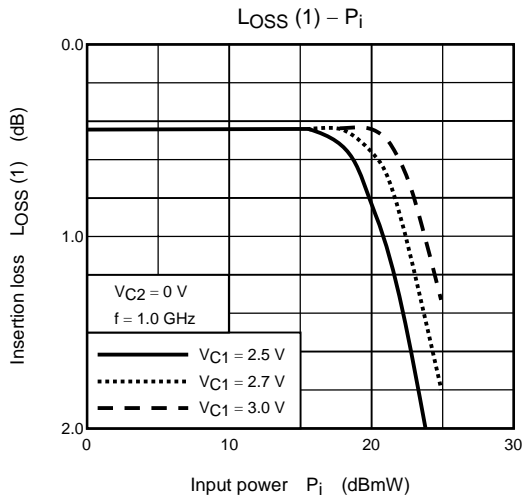

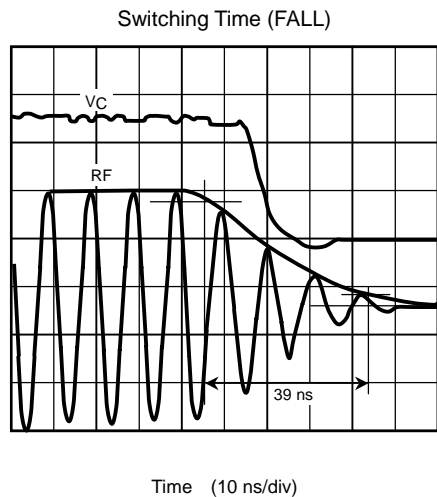
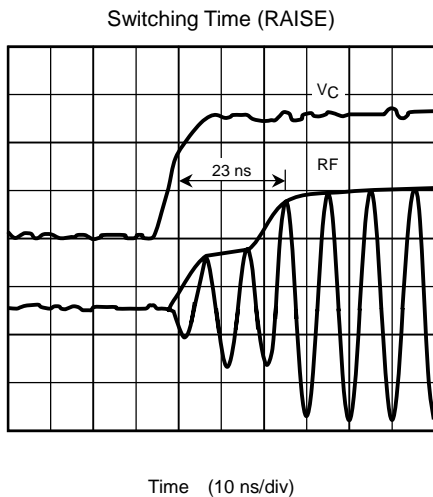
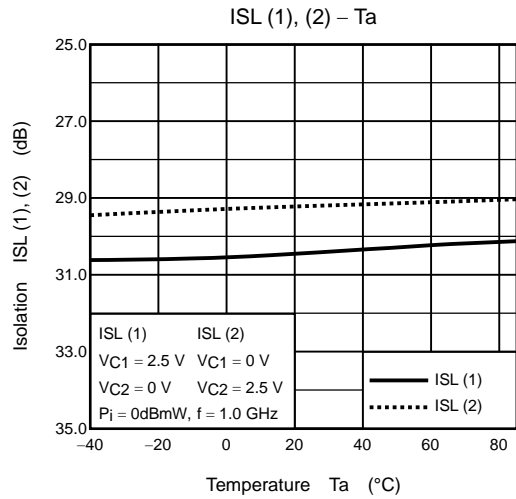
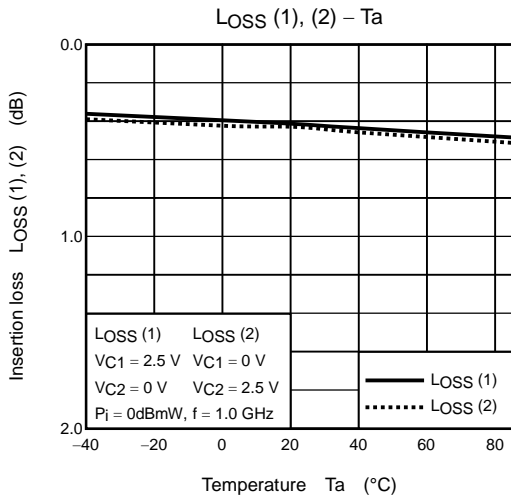
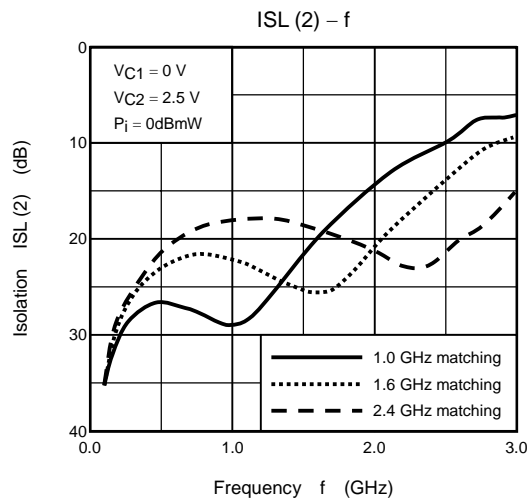
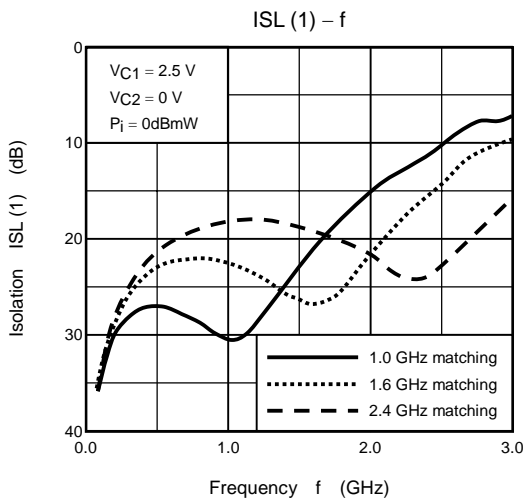

Package Dimensions

SSOP6-P-0.65

Unit: mm

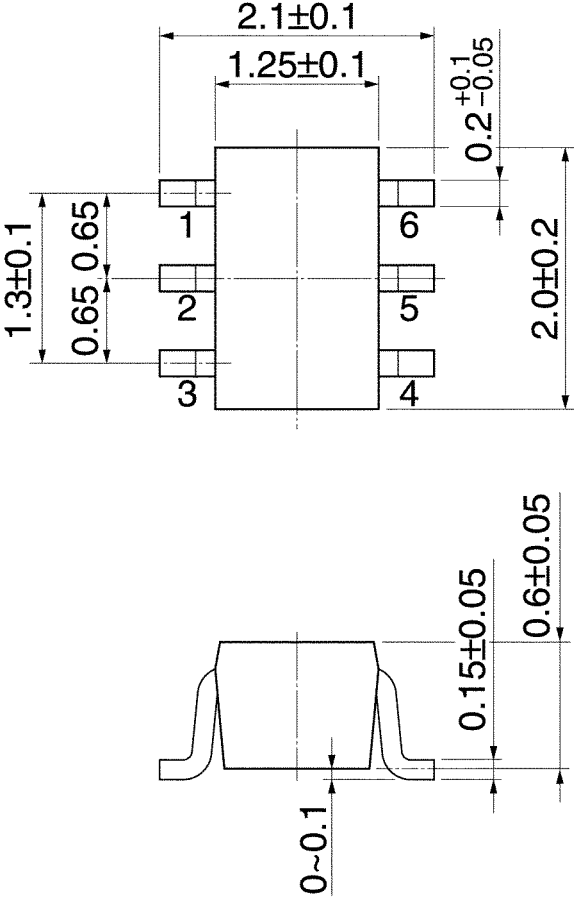

Weight: 0.008 g (typ.)

RESTRICTIONS ON PRODUCT USE

020704EAC

- TOSHIBA is continually working to improve the quality and reliability of its products. Nevertheless, semiconductor devices in general can malfunction or fail due to their inherent electrical sensitivity and vulnerability to physical stress. It is the responsibility of the buyer, when utilizing TOSHIBA products, to comply with the standards of safety in making a safe design for the entire system, and to avoid situations in which a malfunction or failure of such TOSHIBA products could cause loss of human life, bodily injury or damage to property.
In developing your designs, please ensure that TOSHIBA products are used within specified operating ranges as set forth in the most recent TOSHIBA products specifications. Also, please keep in mind the precautions and conditions set forth in the "Handling Guide for Semiconductor Devices," or "TOSHIBA Semiconductor Reliability Handbook" etc..
- The TOSHIBA products listed in this document are intended for usage in general electronics applications (computer, personal equipment, office equipment, measuring equipment, industrial robotics, domestic appliances, etc.). These TOSHIBA products are neither intended nor warranted for usage in equipment that requires extraordinarily high quality and/or reliability or a malfunction or failure of which may cause loss of human life or bodily injury ("Unintended Usage"). Unintended Usage include atomic energy control instruments, airplane or spaceship instruments, transportation instruments, traffic signal instruments, combustion control instruments, medical instruments, all types of safety devices, etc.. Unintended Usage of TOSHIBA products listed in this document shall be made at the customer's own risk.
- Gallium Arsenide (GaAs) is a substance used in the products described in this document. GaAs dust or vapor is harmful to the human body. Do not break , cut, crush or dissolve chemically.
- The information contained herein is presented only as a guide for the applications of our products. No responsibility is assumed by TOSHIBA CORPORATION for any infringements of intellectual property or other rights of the third parties which may result from its use. No license is granted by implication or otherwise under any intellectual property or other rights of TOSHIBA CORPORATION or others.
- The information contained herein is subject to change without notice.