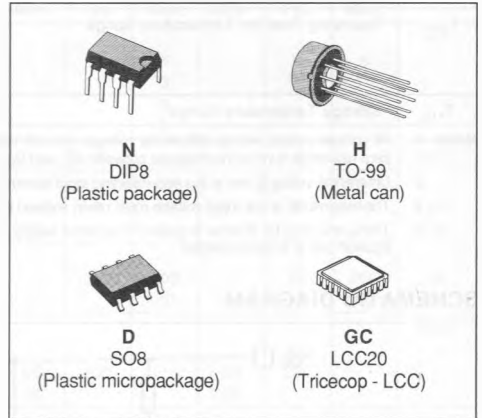

J-FET INPUT DUAL OP-AMPS

- LOW POWER CONSUMPTION
- WIDE COMMON-MODE AND DIFFERENTIAL VOLTAGE RANGE
- LOW INPUT BIAS AND OFFSET CURRENT
- OUTPUT SHORT-CIRCUIT PROTECTION
- HIGH INPUT IMPEDANCE J-FET INPUT STAGE
- INTERNAL FREQUENCY COMPENSATION
- LATCH UP FREE OPERATION
- HIGH SLEW RATE : 13 V/ μ s (typ)

DESCRIPTION

The TL082, TL082A and TL082B are high speed J-FET input dual operational amplifiers incorporating well matched, high voltage J-FET and bipolar transistors in a monolithic integrated circuit.

The devices feature high slew rates, low input bias and offset current, and low offset voltage temperature coefficient.

ORDER CODES

Part Number	Temperature Range	Package			
		N	H	D	GC
TL082M	- 55 °C to + 125 °C		•		•
TL082I	- 40 °C to + 105 °C	•			
TL082C	0 °C to + 70 °C	•		•	
TL082AC	0 °C to + 70 °C	•		•	
TL082BC	0 °C to + 70 °C	•		•	

Note : Hi-Rel Versions Available
Examples : TL082CD, TL082MGC, TL082IN

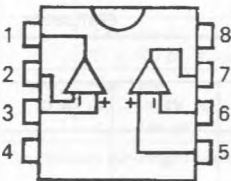
PIN CONNECTIONS (Top views)
**DIP8
SO8**

- 1 - Output (1)
- 2 - Inverting input (1)
- 3 - Non-inverting input (1)
- 4 - V_{CC}

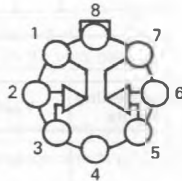
TO-99

- 5 - Non-inverting input (2)
- 6 - Inverting input (2)
- 7 - Output (2)
- 8 - V_{CC}

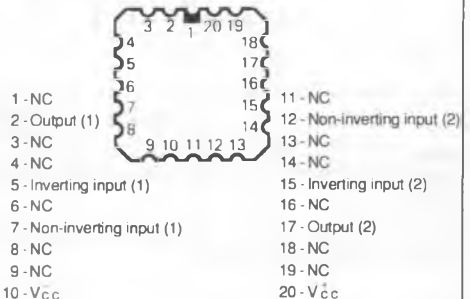
LCC20

MAXIMUM RATINGS

Symbol	Parameter	Value	Unit
V_{CC}	Supply Voltage (note 1)	± 18	V
V_I	Input Voltage (note 3)	± 15	V
V_{ID}	Differential Input Voltage (note 2)	± 30	V
P_{tot}	Power Dissipation	680	mW
	Output Short-circuit Duration (note 4)	Indefinite	
T_{oper}	Operating Free Air Temperature Range	TL082C, AC, BC TL082I, BI TL082M 0 to + 70 - 40 to + 105 - 55 to + 125	$^{\circ}C$
T_{stg}	Storage Temperature Range	- 65 to + 150	$^{\circ}C$

- Notes :**
1. All voltage values, except differential voltage, are with respect to the zero reference level (ground) of the supply voltages where the zero reference level is the midpoint between V_{CC} and V_{CC} .
 2. Differential voltages are at the non-inverting input terminal with respect to the inverting input terminal.
 3. The magnitude of the input voltage must never exceed the magnitude of the supply voltage or 15 volts, whichever is less.
 4. The output may be shorted to ground or to either supply. Temperature and /or supply voltages must be limited to ensure that the dissipation rating is not exceeded.

SCHEMATIC DIAGRAM

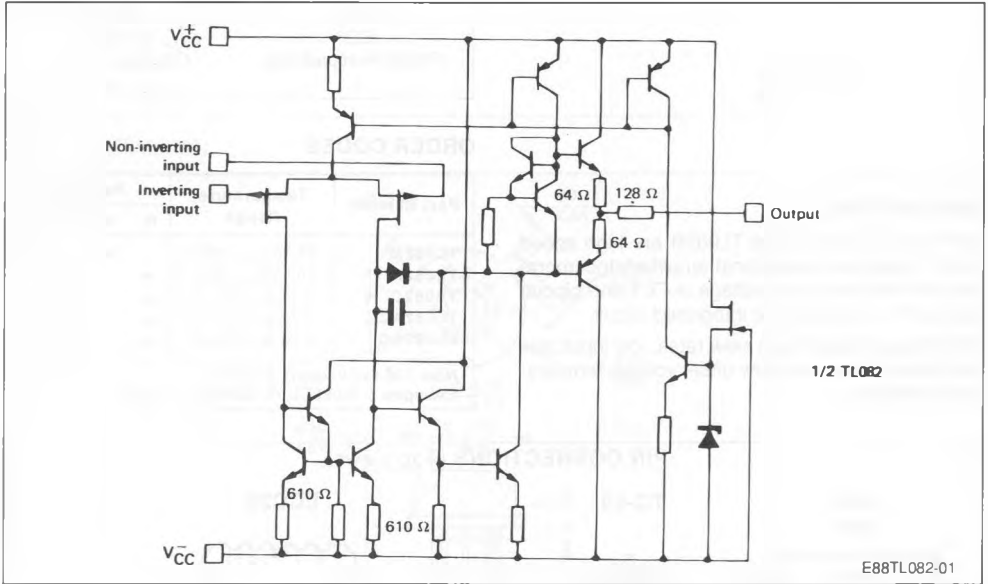

Case	Outputs	Inverting Inputs	Non-inverting Inputs	V_{CC}	V_{CC}	N.C.
DIP8 SO8 TO-99	1, 7	3, 5	2, 6	4	8	
LCC20	2, 17	7, 12	5, 15	10	20	*

* LCC20 : Other pins are not connected.

ELECTRICAL CHARACTERISTICS

 $V_{CC} = \pm 15$ V (unless otherwise specified)TL082M : $-55\text{ }^{\circ}\text{C} \leq T_{amb} \leq +125\text{ }^{\circ}\text{C}$ TL082I, BI : $-40\text{ }^{\circ}\text{C} \leq T_{amb} \leq +105\text{ }^{\circ}\text{C}$ TL082C, AC, BC : $0\text{ }^{\circ}\text{C} \leq T_{amb} \leq +70\text{ }^{\circ}\text{C}$

Symbol	Parameter	TL082M, I, BI TL082BC, AC			TL082C			Unit
		Min.	Typ.	Max.	Min.	Typ.	Max.	
V_{IO}	Input Offset Voltage $T_{amb} = 25\text{ }^{\circ}\text{C}$ ($R_S \leq 10\text{ k}\Omega$) TL082BI, BC $T_{min} \leq T_{amb} \leq T_{max}$ TL082BI, BC		3 1	5 3 9 5		3	8 13	mV
DV_{IO}	Input Offset Voltage Drift		10			10		$\mu\text{V}/^{\circ}\text{C}$
I_{IO}	Input Offset Current * $T_{amb} = 25\text{ }^{\circ}\text{C}$ $T_{min} \leq T_{amb} \leq T_{max}$		5	50 4		5	50 4	pA nA
I_{IB}	Input Bias Current * $T_{amb} = 25\text{ }^{\circ}\text{C}$ $T_{min} \leq T_{amb} \leq +70\text{ }^{\circ}\text{C}$		20	200 20		20	200 20	pA nA
A_{VD}	Large Signal Voltage Gain ($R_L \geq 2\text{ k}\Omega$, $V_O = \pm 10\text{ V}$) $T_{amb} = 25\text{ }^{\circ}\text{C}$ $T_{min} \leq T_{amb} \leq T_{max}$	50 25	200		50 25	200		V/mV
SVR	Supply Voltage Rejection Ratio ($R_S \leq 10\text{ k}\Omega$) $T_{amb} = 25\text{ }^{\circ}\text{C}$ $T_{min} \leq T_{amb} \leq T_{max}$	80 80	86		80 80	86		dB
I_{CC}	Supply Current, per Amp, no Load $T_{amb} = 25\text{ }^{\circ}\text{C}$ $T_{min} \leq T_{amb} \leq T_{max}$		1.4	2.5 2.5		1.4	2.5 2.5	mA
V_I	Input Voltage Range	- 11		+ 11	- 11		+ 11	V
CMR	Common Mode Rejection Ratio ($R_S \leq 10\text{ k}\Omega$) $T_{amb} = 25\text{ }^{\circ}\text{C}$ $T_{min} \leq T_{amb} \leq T_{max}$	80 80	86		70 70	86		dB
I_{OS}	Output Short-circuit Current $T_{amb} = 25\text{ }^{\circ}\text{C}$ $T_{min} \leq T_{amb} \leq T_{max}$	10 10	40	60 60	10 10	40	60 60	mA
$\pm V_{OPP}$	Output Voltage Swing $T_{amb} = 25\text{ }^{\circ}\text{C}$ $T_{min} \leq T_{amb} \leq T_{max}$		11 12 11 12	12 13.5		11 12 11 12	12 13.5	V
S_{VO}	Slew-rate ($V_I = 10\text{ V}$, $R_L = 2\text{ k}\Omega$) $C_L \leq 100\text{ pF}$, $T_{amb} = 25\text{ }^{\circ}\text{C}$, unity gain)	12	16		8	16		$\text{V}/\mu\text{s}$
t_r	Rise Time ($V_I = 20\text{ mV}$, $R_L = 2\text{ k}\Omega$) $C_L = 100\text{ pF}$, $T_{amb} = 25\text{ }^{\circ}\text{C}$, unity gain)		0.1			0.1		μs

* The input bias currents are junction leakage currents which approximately double for every $10\text{ }^{\circ}\text{C}$ increase in the junction temperature.

ELECTRICAL CHARACTERISTICS (continued)

Symbol	Parameter	TL082M, I, BI TL082BC, AC			TL082C			Unit
		Min.	Typ.	Max.	Min.	Typ.	Max.	
K_{OV}	Overshoot ($V_I = 20$ mV, $R_L = 2$ k Ω $C_L \leq 100$ pF, $T_{amb} = 25$ °C, unity gain)		10			10		%
GBP	Gain Bandwidth Product ($f = 100$ kHz, $T_{amb} = 25$ °C $V_{IN} = 10$ mV, $R_L = 2$ k Ω , $C_L = 100$ pF) TL082BI, BC	2.5 3.3	4.0 4.0	5.0 5.0	2.5	4.0	5.0	MHz
R_i	Input Resistance ($T_{amb} = 25$ °C)		10^{12}			10^{12}		Ω
THD	Total Harmonic Distortion ($f = 1$ kHz, $A_V = 20$ dB, $R_L = 2$ k Ω $C_L \leq 100$ pF, $T_{amb} = 25$ °C, $V_O = 2$ V _{PP})		0.01			0.01		%
V_n	Equivalent Input Noise Voltage ($f = 1$ kHz, $R_g = 100$ Ω)		15			15		nV/ \sqrt{Hz}
ϕ_m	Phase Margin		45			45		Degrees
V_{O1} / V_{O2}	Channel Separation $A_{vd} = 100$, $T_{amb} = 25$ °C		120			120		dB

TYPICAL CHARACTERISTICS

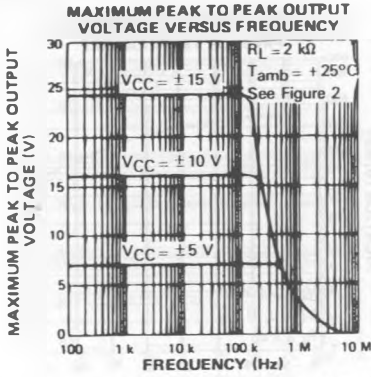

E88TL072-02

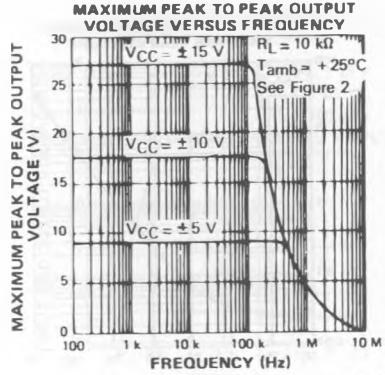

E88TL072-03

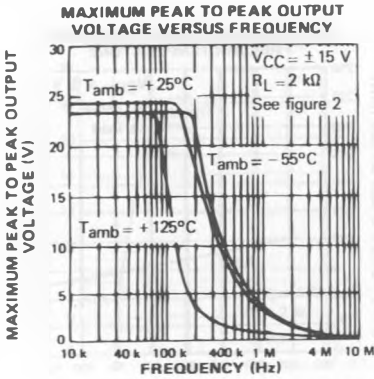

E88TL072-04

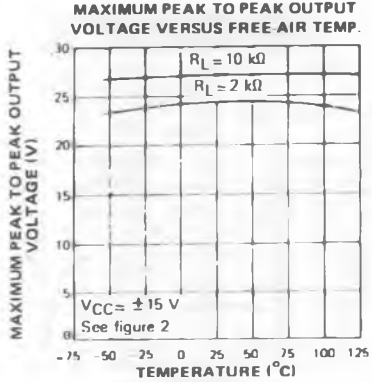

E88TL072-05

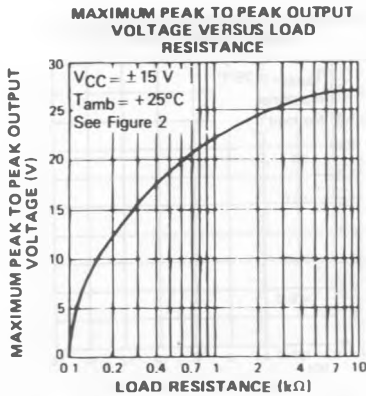

E88TL072-06

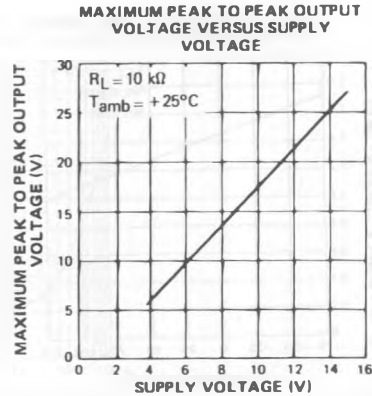

E88TL072-07

TYPICAL CHARACTERISTICS (continued)

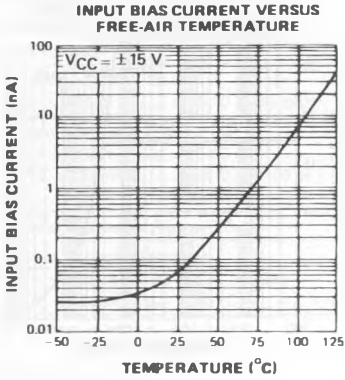

E88TL072-08

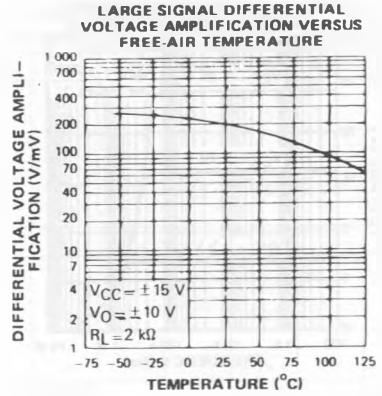

E88TL072-09

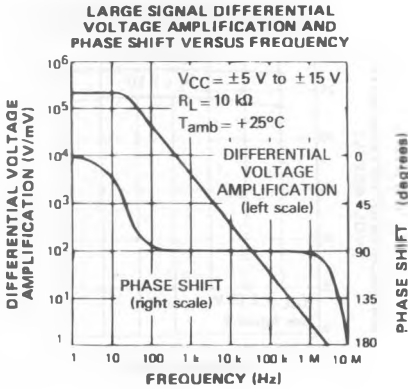

E88TL072-10

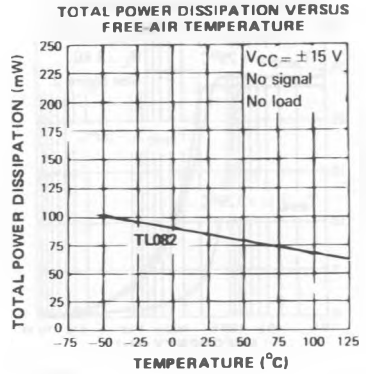

E88TL072-11

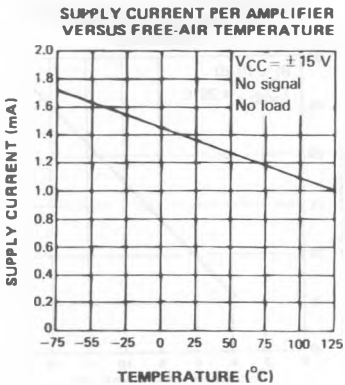

E88TL072-12

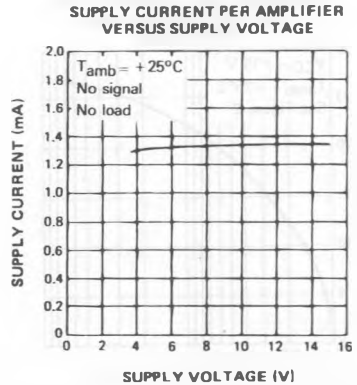

E88TL082-02

TYPICAL CHARACTERISTICS (continued)

COMMON MODE REJECTION RATIO
VERSUS FREE AIR TEMPERATURE

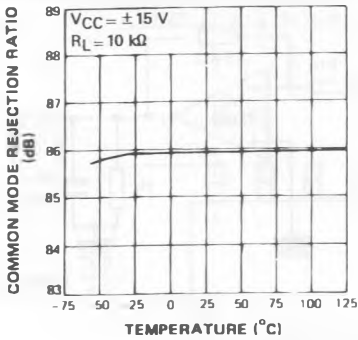

E88TL072-13

VOLTAGE FOLLOWER LARGE
SIGNAL PULSE RESPONSE

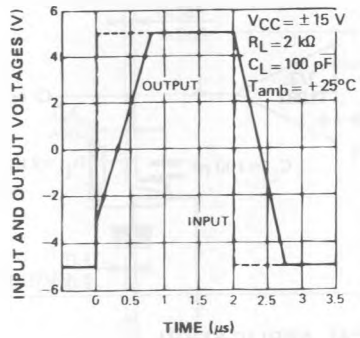

E88TL072-14

OUTPUT VOLTAGE VERSUS TIME

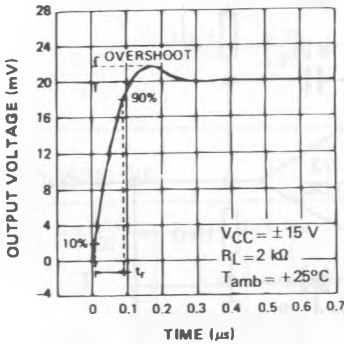

E88TL072-15

EQUIVALENT INPUT NOISE VOL-
TAGE VERSUS FREQUENCY

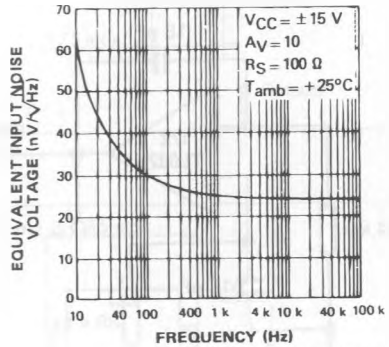

E88TL072-16

TOTAL HARMONIC DISTORTION
VERSUS FREQUENCY

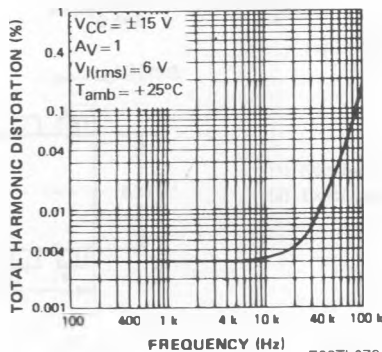

E88TL072-17

PARAMETER MEASUREMENT INFORMATION

Figure 1 : Voltage follower.

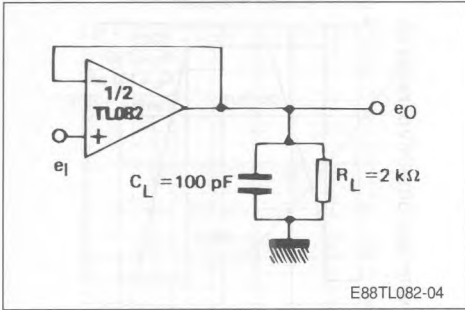
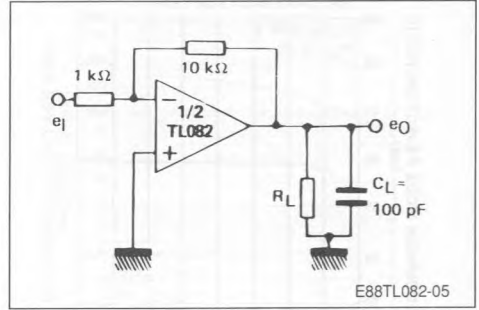
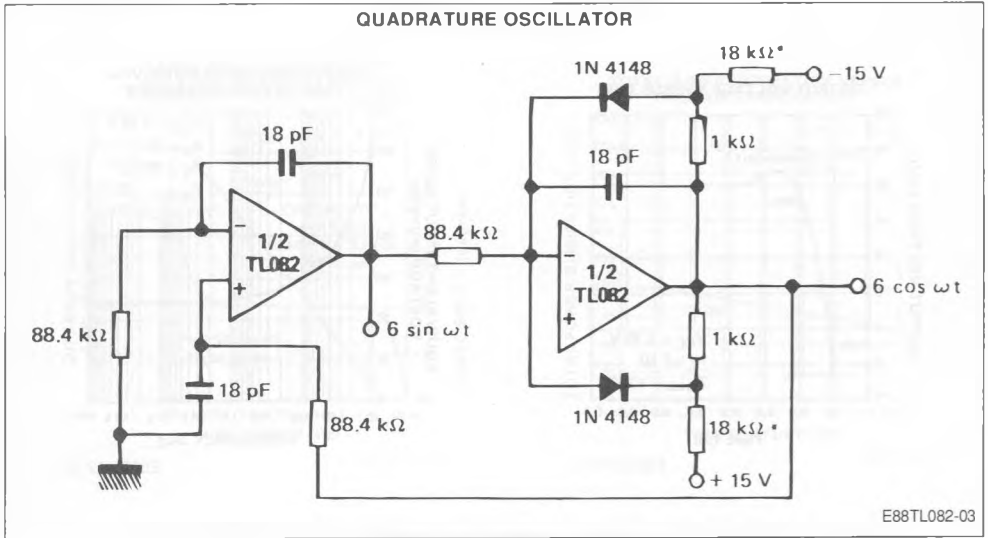

Figure 2 : Gain-of-10 inverting amplifier.



TYPICAL APPLICATION



PACKAGE MECHANICAL DATA

8 PINS - PLASTIC MICROPACKAGE (SO)

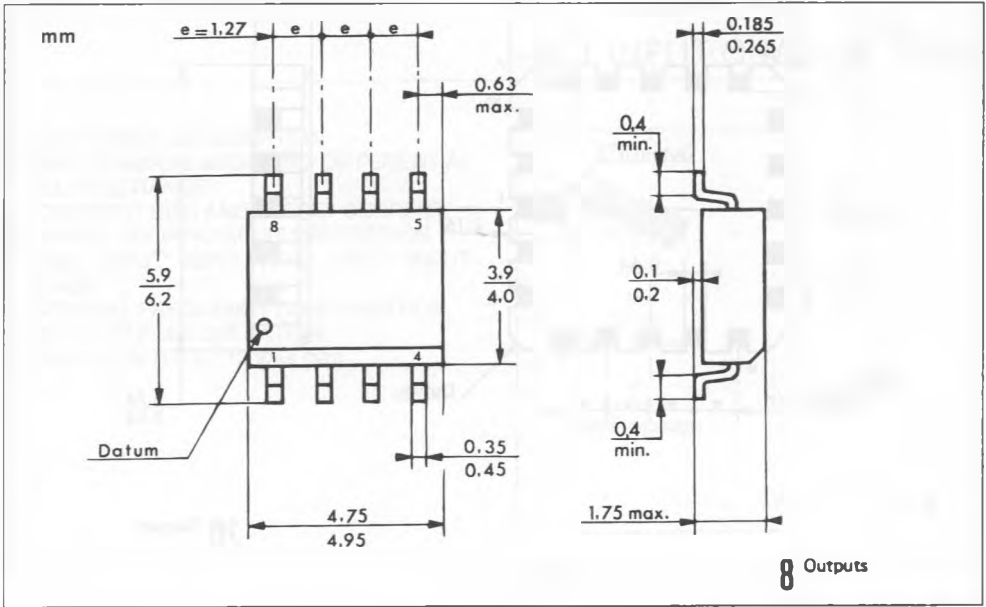

8 PINS - PLASTIC DIP

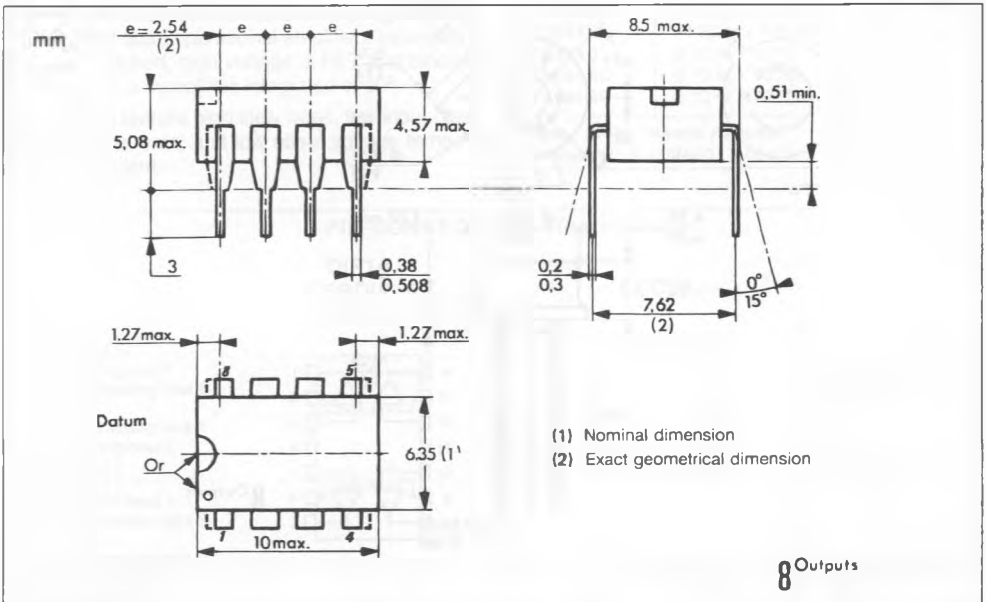

20 PINS - TRICECOP (LCC)

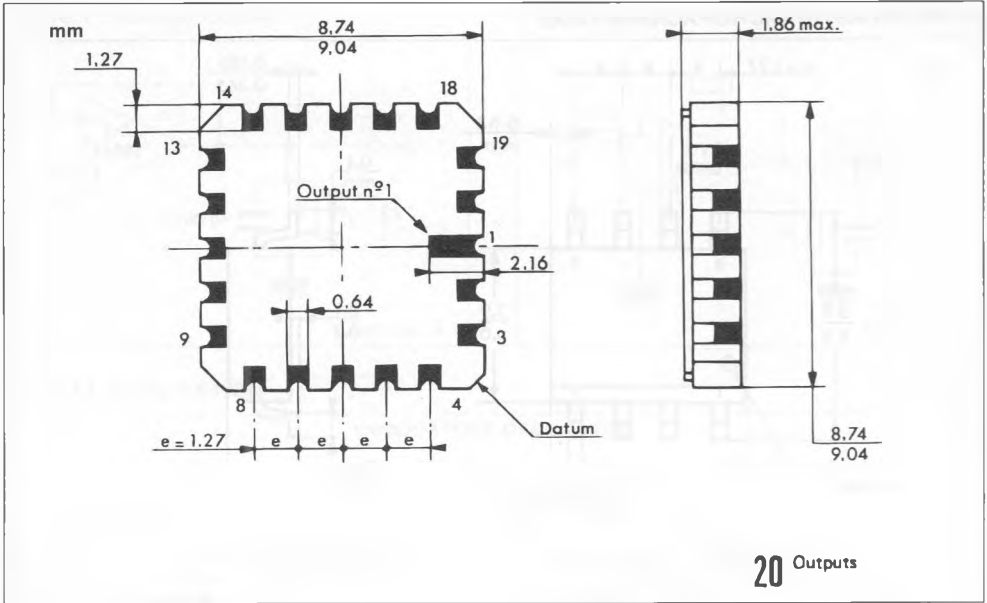

TO-99 - METAL CAN

