

# TL1454, TL1454Y DUAL-CHANNEL PULSE-WIDTH-MODULATION (PWM) CONTROL CIRCUIT

SLVS086B – APRIL 1995 – REVISED NOVEMBER 1997

- Two Complete PWM Control Circuits
- Outputs Drive MOSFETs Directly
- Oscillator Frequency . . . 50 kHz to 2 MHz
- 3.6-V to 20-V Supply-Voltage Range
- Low Supply Current . . . 3.5 mA Typ
- Adjustable Dead-Time Control, 0% to 100%
- 1.25-V Reference

D, N OR PW PACKAGE  
(TOP VIEW)

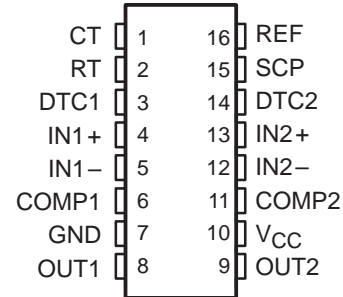

## description

The TL1454 is a dual-channel pulse-width-modulation (PWM) control circuit, primarily intended for low-power, dc/dc converters. Applications include LCD displays, backlight inverters, notebook computers, and other products requiring small, high-frequency, dc/dc converters. Each PWM channel has its own error amplifier, PWM comparator, dead-time control comparator, and MOSFET driver. The voltage reference, oscillator, undervoltage lockout, and short-circuit protection are common to both channels.

Channel 1 is configured to drive n-channel MOSFETs in step-up or flyback converters, and channel 2 is configured to drive p-channel MOSFETs in step-down or inverting converters. The operating frequency is set with an external resistor and an external capacitor, and dead time is continuously adjustable from 0 to 100% duty cycle with a resistive divider network. Soft start can be implemented by adding a capacitor to the dead-time control (DTC) network. The error-amplifier common-mode input range includes ground, which allows the TL1454 to be used in ground-sensing battery chargers as well as voltage converters.

### AVAILABLE OPTIONS

T <sub>A</sub>	PACKAGED DEVICES†			CHIP FORM (Y)
	SMALL OUTLINE (D)	PLASTIC DIP (N)	TSSOP (PW)	
–20°C to 85°C	TL1454CD	TL1454CN	TL1454CPWLE	TL1454Y
–40°C to 85°C	TL1454ID	TL1454IN	—	—

† The D package is available taped and reeled. Add the suffix R to the device name (e.g., TL1454CDR). The PW package is available only left-end taped and reeled (indicated by the LE suffix on the device type; e.g., TL1454CPWLE).

# TL1454, TL1454Y

## DUAL-CHANNEL PULSE-WIDTH-MODULATION (PWM) CONTROL CIRCUIT

SLVS086B – APRIL 1995 – REVISED NOVEMBER 1997

### functional block diagram

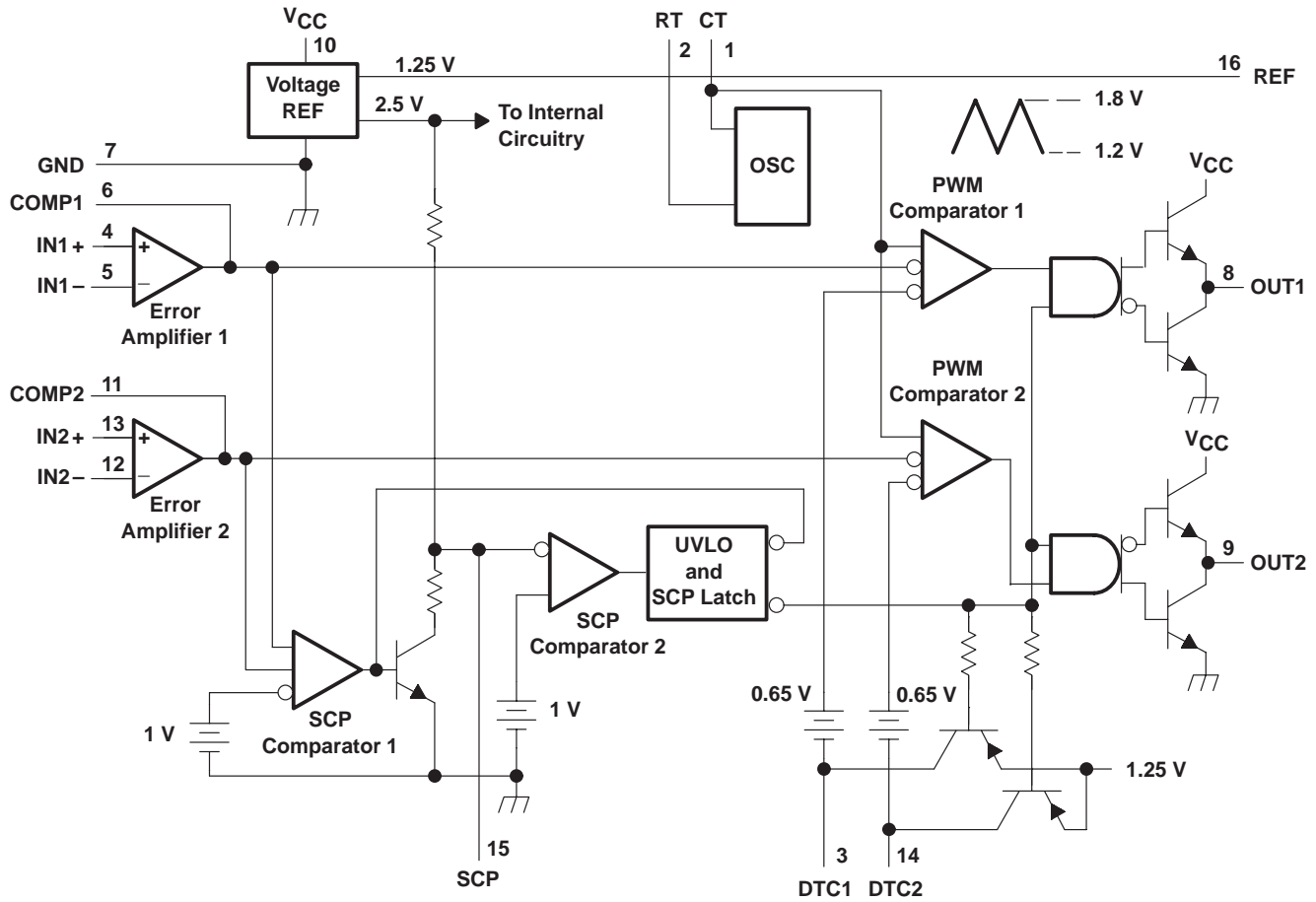

# TL1454, TL1454Y DUAL-CHANNEL PULSE-WIDTH-MODULATION (PWM) CONTROL CIRCUIT

SLVS086B – APRIL 1995 – REVISED NOVEMBER 1997

## TL1454Y chip information

This chip, when properly assembled, displays characteristics similar to the TL1454C. Thermal compression or ultrasonic bonding may be used on the doped aluminum bonding pads. The chips may be mounted with conductive epoxy or a gold-silicon preform.

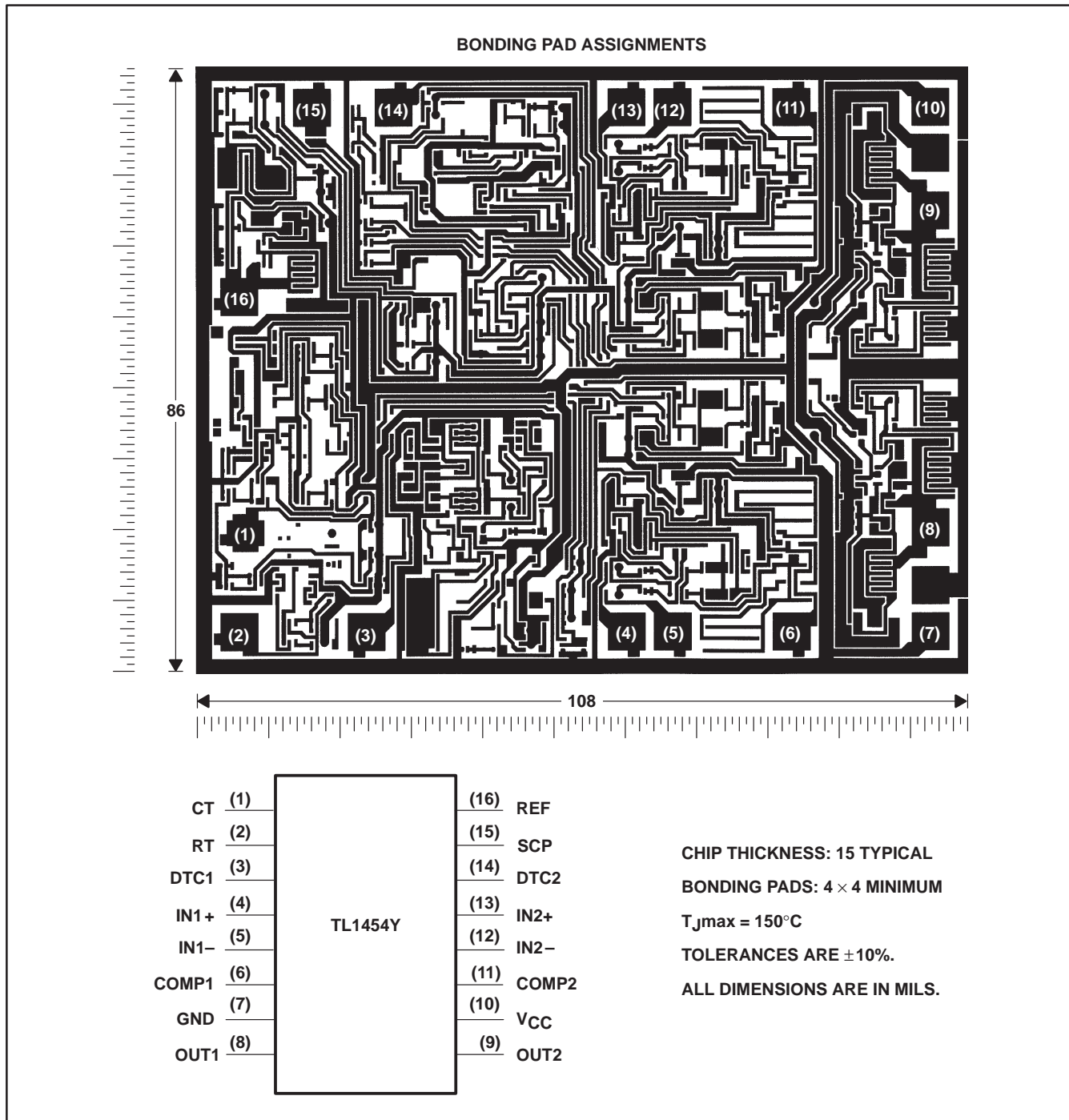

# TL1454, TL1454Y

## DUAL-CHANNEL PULSE-WIDTH-MODULATION (PWM) CONTROL CIRCUIT

SLVS086B – APRIL 1995 – REVISED NOVEMBER 1997

### theory of operation

#### reference voltage

A linear regulator operating from  $V_{CC}$  generates a 2.5-V supply for the internal circuits and the 1.25-V reference, which can source a maximum of 1 mA for external loads. A small ceramic capacitor (0.047  $\mu$ F to 0.1  $\mu$ F) between REF and ground is recommended to minimize noise pickup.

#### error amplifier

The error amplifier generates the error signal used by the PWM to adjust the power-switch duty cycle for the desired converter output voltage. The signal is generated by comparing a sample of the output voltage to the voltage reference and amplifying the difference. An external resistive divider connected between the converter output and ground, as shown in Figure 1, is generally required to obtain the output voltage sample.

The amplifier output is brought out on COMP to allow the frequency response of the amplifier to be shaped with an external RC network to stabilize the feedback loop of the converter. DC loading on the COMP output is limited to 45  $\mu$ A (the maximum amplifier source current capability).

Figure 1 illustrates the sense-divider network and error-amplifier connections for converters with positive output voltages. The divider network is connected to the noninverting amplifier input because the PWM has a phase inversion; the duty cycle decreases as the error-amplifier output increases.

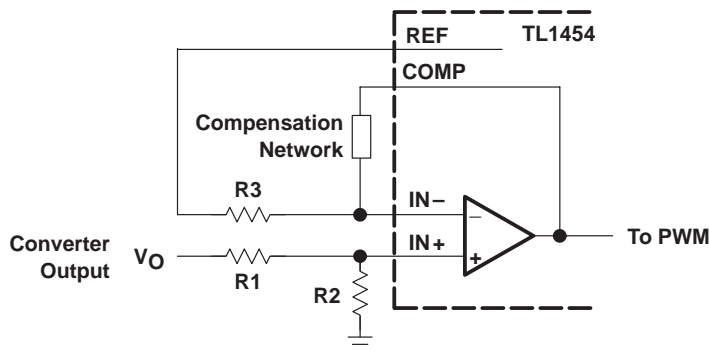

**Figure 1. Sense Divider/Error Amplifier Configuration for Converters with Positive Outputs**

The output voltage is given by:

$$V_O = V_{ref} \left( 1 + \frac{R_1}{R_2} \right)$$

where  $V_{ref} = 1.25$  V.

The dc source resistance of the error-amplifier inputs should be 10 k $\Omega$  or less and approximately matched to minimize output voltage errors caused by the input-bias current. A simple procedure for determining appropriate values for the resistors is to choose a convenient value for R3 (10 k $\Omega$  or less) and calculate R1 and R2 using:

$$R_1 = \frac{R_3 V_O}{V_O - V_{ref}}$$

$$R_2 = \frac{R_3 V_O}{V_{ref}}$$

**error amplifier**

R1 and R2 should be tight-tolerance ( $\pm 1\%$  or better) devices with low and/or matched temperature coefficients to minimize output voltage errors. A device with a  $\pm 5\%$  tolerance is suitable for R3.

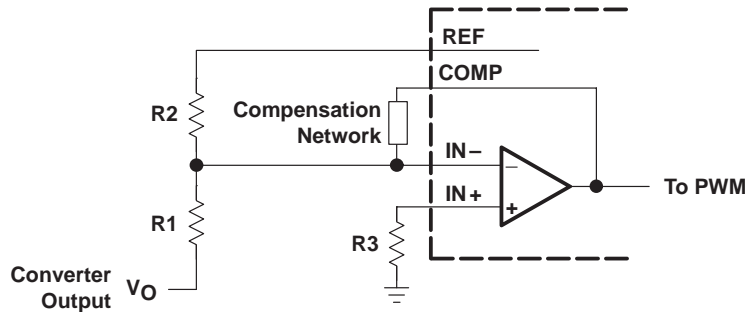

**Figure 2. Sense Divider/Error Amplifier Configuration for Converters with Negative Outputs**

Figure 2 shows the divider network and error-amplifier configuration for negative output voltages. In general, the comments for positive output voltages also apply for negative outputs. The output voltage is given by:

$$V_O = - \frac{R_1 V_{ref}}{R_2}$$

The design procedure for choosing the resistor value is to select a convenient value for R2 (instead of R3 in the procedure for positive outputs) and calculate R1 and R3 using:

$$R_1 = - \frac{R_2 V_O}{V_{ref}}$$

$$R_3 = \frac{R_1 R_2}{R_1 + R_2}$$

Values in the 10-k $\Omega$  to 20-k $\Omega$  range work well for R2. R3 can be omitted and the noninverting amplifier connected to ground in applications where the output voltage tolerance is not critical.

**oscillator**

The oscillator frequency can be set between 50 kHz and 2 MHz with a resistor connected between RT and GND and a capacitor between CT and GND (see Figure 3). Figure 6 is used to determine RT and CT for the desired operating frequency. Both components should be tight-tolerance, temperature-stable devices to minimize frequency deviation. A 1% metal-film resistor is recommended for RT, and a 10%, or better, NPO ceramic capacitor is recommended for CT.

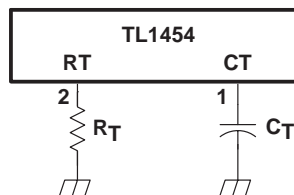

**Figure 3. Oscillator Timing**

# TL1454, TL1454Y

## DUAL-CHANNEL PULSE-WIDTH-MODULATION (PWM) CONTROL CIRCUIT

SLVS086B – APRIL 1995 – REVISED NOVEMBER 1997

### dead-time control (DTC) and soft start

The two PWM channels have independent dead-time control inputs so that the maximum power-switch duty cycles can be limited to less than 100%. The dead-time is set with a voltage applied to DTC; the voltage is typically obtained from a resistive divider connected between the reference and ground as shown in Figure 4. Soft start is implemented by adding a capacitor between REF and DTC.

The voltage,  $V_{DT}$ , required to limit the duty cycle to a maximum value is given by:

$$V_{DT} = V_{O(max)} - D(V_{O(max)} - V_{O(min)}) - 0.65$$

where  $V_{O(max)}$  and  $V_{O(min)}$  are obtained from Figure 9, and  $D$  is the maximum duty cycle.

Predicting the regulator startup or rise time is complicated because it depends on many variables, including: input voltage, output voltage, filter values, converter topology, and operating frequency. In general, the output will be in regulation within two time constants of the soft-start circuit. A five-to-ten millisecond time constant usually works well for low-power converters.

The DTC input can be grounded in applications where achieving a 100% duty cycle is desirable, such as a buck converter with a very low input-to-output differential voltage. However, grounding DTC prevents the implementation of soft start, and the output voltage overshoot at power-on is likely to be very large. A better arrangement is to omit  $R_{DT1}$  (see Figure 4) and choose  $R_{DT2} = 47 \text{ k}\Omega$ . This configuration ensures that the duty cycle can reach 100% and still allows the designer to implement soft start using  $C_{SS}$ .

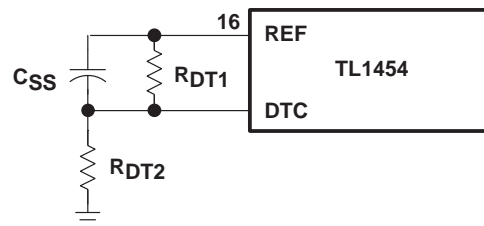

Figure 4. Dead-Time Control and Soft Start

### PWM comparator

Each of the PWM comparators has dual inverting inputs. One inverting input is connected to the output of the error amplifier; the other inverting input is connected to the DTC terminal. Under normal operating conditions, when either the error-amplifier output or the dead-time control voltage is higher than that for the PWM triangle wave, the output stage is set inactive (OUT1 low and OUT2 high), turning the external power stage off.

### undervoltage-lockout (UVLO) protection

The undervoltage-lockout circuit turns the output circuit off and resets the SCP latch whenever the supply voltage drops too low (to approximately 2.9 V) for proper operation. A hysteresis voltage of 200 mV eliminates false triggering on noise and chattering.

### short-circuit protection (SCP)

The TL1454 SCP function prevents damage to the power switches when the converter output is shorted to ground. In normal operation, SCP comparator 1 clamps SCP to approximately 185 mV. When one of the converter outputs is shorted, the error amplifier output (COMP) will be driven below 1 V to maximize duty cycle and force the converter output back up. When the error amplifier output drops below 1 V, SCP comparator 1 releases SCP, and capacitor,  $C_{SCP}$ , which is connected between SCP and GND, begins charging. If the error-amplifier output rises above 1 V before  $C_{SCP}$  is charged to 1 V, SCP comparator 1 discharges  $C_{SCP}$  and normal operation resumes. If  $C_{SCP}$  reaches 1 V, SCP comparator 2 turns on and sets the SCP latch, which turns off the output drives and resets the soft-start circuit. The latch remains set until the supply voltage is lowered to 2 V or less, or  $C_{SCP}$  is discharged externally.



**short-circuit protection (SCP) (continued)**

The SCP time-out period must be greater than the converter start-up time or the converter will not start. Because high-value capacitor tolerances tend to be ±20% or more and IC resistor tolerances are loose as well, it is best to choose an SCP time-out period 10-to-15 times greater than the converter startup time. The value of C<sub>SCP</sub> may be determined using Figure 6, or it can be calculated using:

$$C_{SCP} = \frac{T_{SCP}}{80.3}$$

where C<sub>SCP</sub> is in µF and T<sub>SCP</sub> is the time-out period in ms.

**output stage**

The output stage of the TL1454 is a totem-pole output with a maximum source/sink current rating of 40 mA and a voltage rating of 20 V. The output is controlled by a complementary output AND gate and is turned on (sourcing current for OUT1, sinking current for OUT2) when all the following conditions are met: 1) the oscillator triangle wave voltage is higher than both the DTC voltage and the error-amplifier output voltage, 2) the undervoltage-lockout circuit is inactive, and 3) the short-circuit protection circuit is inactive.

**absolute maximum ratings over operating free-air temperature range (unless otherwise noted)†**

Supply voltage, V <sub>CC</sub> (see Note 1)	23 V
Error amplifier input voltage: IN1+, IN1–, IN2+, IN2–	23 V
Output voltage: OUT1, OUT2	20 V
Continuous output current: OUT1, OUT2	±200 mA
Peak output current: OUT1, OUT2	1 A
Continuous total dissipation	See Dissipation Rating Table
Operating free-air temperature range, T <sub>A</sub> : C suffix	–20°C to 85°C
I suffix	–40°C to 85°C
Storage temperature range, T <sub>stg</sub>	–65°C to 150°C
Lead temperature 1,6 mm (1/16 inch) from case for 10 seconds	260°C

† Stresses beyond those listed under “absolute maximum ratings” may cause permanent damage to the device. These are stress ratings only, and functional operation of the device at these or any other conditions beyond those indicated under “recommended operating conditions” is not implied. Exposure to absolute-maximum-rated conditions for extended periods may affect device reliability.

NOTE 1: All voltage values are with respect to network GND.

**DISSIPATION RATING TABLE**

PACKAGE	T <sub>A</sub> ≤ 25°C	DERATING FACTOR	T <sub>A</sub> = 70°C	T <sub>A</sub> = 85°C
	POWER RATING	ABOVE T <sub>A</sub> = 25°C	POWER RATING	POWER RATING
D	950 mW	7.6 mW/°C	608 mW	494 mW
N	1250 mW	10.0 mW/°C	800 mW	650 mW
PW	500 mW	4.0 mW/°C	320 mW	260 mW



# TL1454, TL1454Y

## DUAL-CHANNEL PULSE-WIDTH-MODULATION (PWM)

### CONTROL CIRCUIT

SLVS086B – APRIL 1995 – REVISED NOVEMBER 1997

#### recommended operating conditions

		MIN	MAX	UNIT
Supply voltage, $V_{CC}$		3.6	20	V
Error amplifier common-mode input voltage		-0.2	1.45	V
Output voltage, $V_O$			20	V
Output current, $I_O$			±40	mA
COMP source current			-45	μA
COMP sink current			100	μA
Reference output current			1	mA
COMP dc load resistance		100		kΩ
Timing capacitor, $C_T$		10	4000	pF
Timing resistor, $R_T$		5.1	100	kΩ
Oscillator frequency		50	2000	kHz
Operating free-air temperature, $T_A$	TL1454C	-20	85	°C
	TL1454I	-40	85	

electrical characteristics over recommended operating free-air temperature range,  $V_{CC} = 6\text{ V}$ ,  $f_{osc} = 500\text{ kHz}$  (unless otherwise noted)

#### reference

PARAMETER	TEST CONDITIONS	TL1454			UNIT
		MIN	TYP	MAX	
$V_{ref}$ Output voltage, REF	$I_O = 1\text{ mA}$ , $T_A = 25^\circ\text{C}$	1.23	1.25	1.28	V
	$I_O = 1\text{ mA}$	1.2		1.31	
Input regulation	$V_{OC} = 3.6\text{ V to } 20\text{ V}$ , $I_O = 1\text{ mA}$		2	6	mV
Output regulation	$I_O = 0.1\text{ mA to } 1\text{ mA}$		1	7.5	mV
Output voltage change with temperature	$T_A = T_{A(\text{min})}$ to $25^\circ\text{C}$ , $I_O = 1\text{ mA}$	-12.5	-1.25	12.5	mV
	$T_A = 25^\circ\text{C to } 85^\circ\text{C}$ , $I_O = 1\text{ mA}$	-12.5	-2.5	12.5	
$I_{OS}$ Short-circuit output current	$V_{ref} = 0\text{ V}$		30		mA

#### undervoltage lockout (UVLO)

PARAMETER	TEST CONDITIONS	TL1454			UNIT
		MIN	TYP	MAX	
$V_{IT+}$ Positive-going threshold voltage	$T_A = 25^\circ\text{C}$		2.9		V
$V_{IT-}$ Negative-going threshold voltage			2.7		V
$V_{hys}$ Hysteresis, $V_{IT+} - V_{IT-}$		100	200		mV

#### short-circuit protection (SCP)

PARAMETER	TEST CONDITIONS	TL1454			UNIT
		MIN	TYP	MAX	
$V_{IT}$ Input threshold voltage	$T_A = 25^\circ\text{C}$	0.95	1	1.05	V
$V_{stby}^\dagger$ Standby voltage	No pullup	140	185	230	mV
$V_{I(\text{latched})}$ Latched-mode input voltage		60	120		mV
$V_{IT(\text{COMP})}$ Comparator threshold voltage	COMP1, COMP2		1		V
Input source current	$T_A = 25^\circ\text{C}$ , $V_{O(\text{SCP})} = 0$	-5	-15	-20	μA

<sup>†</sup> This symbol is not presently listed within EIA/JEDEC standards for semiconductor symbology.





**TL1454, TL1454Y**  
**DUAL-CHANNEL PULSE-WIDTH-MODULATION (PWM)**  
**CONTROL CIRCUIT**

SLVS086B – APRIL 1995 – REVISED NOVEMBER 1997

**electrical characteristics over recommended operating free-air temperature range,  $V_{CC} = 6\text{ V}$ ,  $f_{osc} = 500\text{ kHz}$  (unless otherwise noted) (continued)**

**oscillator**

PARAMETER		TEST CONDITIONS	TL1454			UNIT
			MIN	TYP	MAX	
$f_{osc}$	Frequency	$C_T = 120\text{ pF}$ , $R_T = 10\text{ k}\Omega$		500		kHz
	Standard deviation of frequency			50		kHz
	Frequency change with voltage	$V_{CC} = 3.6\text{ V to }20\text{ V}$ , $T_A = 25^\circ\text{C}$		5		kHz
	Frequency change with temperature	$T_A = T_{A(\text{min})}$ to $25^\circ\text{C}$		-2	$\pm 20$	kHz
		$T_A = 25^\circ\text{C}$ to $85^\circ\text{C}$		-10	$\pm 20$	
	Maximum ramp voltage			1.8		V
	Minimum ramp voltage			1.1		V

**dead-time control (DTC)**

PARAMETER		TEST CONDITIONS	TL1454			UNIT
			MIN	TYP	MAX	
$V_{IT}$	Input threshold voltage	Duty cycle = 0%	1	1.1	1.2	V
		Duty cycle = 100%	0.4	0.5	0.6	
$V_{I(\text{latched})}$	Latched-mode input voltage			1.2		V
$I_{IB}$	Common-mode input bias current	DTC1, $IN1+ \approx 1.2\text{ V}$			4	$\mu\text{A}$
	Latched-mode (source) current	$T_A = 25^\circ\text{C}$		-100		$\mu\text{A}$

**error-amplifier**

PARAMETER		TEST CONDITIONS	TL1454			UNIT
			MIN	TYP	MAX	
$V_{IO}$	Input offset voltage				6	mV
$I_{IO}$	Input offset current	$V_O = 1.25\text{ V}$ , $V_{IC} = 1.25\text{ V}$			100	nA
$I_{IB}$	Input bias current			-160	-500	nA
$V_{ICR}$	Input voltage range	$V_{CC} = 3.6\text{ V to }20\text{ V}$	-0.2 to 1.40			V
$A_V$	Open-loop voltage gain	$R_{FB} = 200\text{ k}\Omega$	70	80		dB
	Unity-gain bandwidth			3		MHz
CMRR	Common-mode rejection ratio		60	80		dB
$V_{OM(\text{max})}$	Positive output voltage swing		2.3	2.43		V
$V_{OM(\text{min})}$	Negative output voltage swing			0.63	0.8	
$I_{O+}$	Output sink current	$V_{ID} = -0.1\text{ V}$ , $V_O = 1.20\text{ V}$	0.1	0.5		mA
$I_{O-}$	Output source current	$V_{ID} = 0.1\text{ V}$ , $V_O = 1.80\text{ V}$	-45	-70		$\mu\text{A}$

**output**

PARAMETER		TEST CONDITIONS	TL1454			UNIT
			MIN	TYP	MAX	
$V_{OH}$	High-level output voltage	$I_O = -8\text{ mA}$	$V_{CC}-2$	4.5		V
		$I_O = -40\text{ mA}$	$V_{CC}-2$	4.4		
$V_{OL}$	Low-level output voltage	$I_O = 8\text{ mA}$		0.1	0.4	V
		$I_O = 40\text{ mA}$		1.8	2.5	
$t_{rv}$	Output voltage rise time	$C_L = 2000\text{ pF}$ , $T_A = 25^\circ\text{C}$		220		ns
$t_{fv}$	Output voltage fall time			220		



# TL1454, TL1454Y

## DUAL-CHANNEL PULSE-WIDTH-MODULATION (PWM)

### CONTROL CIRCUIT

SLVS086B – APRIL 1995 – REVISED NOVEMBER 1997

electrical characteristics over recommended operating free-air temperature range,  $V_{CC} = 6\text{ V}$ ,  $f_{osc} = 500\text{ kHz}$  (unless otherwise noted) (continued)

#### supply current

PARAMETER	TEST CONDITIONS	TL1454			UNIT
		MIN	TYP	MAX	
$I_{CC(stby)}$ Standby supply current	RT open, $C_T = 1.5\text{ V}$ , No load, $V_O(\text{COMP1, COMP2}) = 1.25\text{ V}$ ,		3.1	6	mA
$I_{CC(average)}$ Average supply current	$R_T = 10\text{ k}\Omega$ , $C_T = 120\text{ pF}$ , 50% duty cycle, Outputs open		3.5	7	mA

electrical characteristics,  $V_{CC} = 6\text{ V}$ ,  $f_{osc} = 500\text{ kHz}$ ,  $T_A = 25^\circ\text{C}$  (unless otherwise noted)

#### reference

PARAMETER	TEST CONDITIONS	TL1454Y			UNIT
		MIN	TYP	MAX	
$V_{ref}$ Output voltage, REF	$I_O = 1\text{ mA}$ ,		1.25		V
Input regulation	$V_{OC} = 3.6\text{ V to }20\text{ V}$ , $I_O = 1\text{ mA}$		2		mV
Output regulation	$I_O = 0.1\text{ mA to }1\text{ mA}$		1		mV
Output voltage change with temperature	$I_O = 1\text{ mA}$		-1.25		mV
	$I_O = 1\text{ mA}$		-2.5		
$I_{OS}$ Short-circuit output current	$V_{ref} = 0\text{ V}$		30		mA

#### undervoltage lockout (UVLO)

PARAMETER	TEST CONDITIONS	TL1454Y			UNIT
		MIN	TYP	MAX	
$V_{IT+}$ Positive-going threshold voltage			2.9		V
$V_{IT-}$ Negative-going threshold voltage			2.7		V
$V_{hys}$ Hysteresis, $V_{IT+} - V_{IT-}$			200		mV

#### short-circuit protection (SCP)

PARAMETER	TEST CONDITIONS	TL1454Y			UNIT
		MIN	TYP	MAX	
$V_{IT}$ Input threshold voltage			1		V
$V_{stby}^\dagger$ Standby voltage	No pullup		185		mV
$V_{I(latched)}$ Latched-mode input voltage			60		mV
$V_{IT(COMP)}$ Comparator threshold voltage	COMP1, COMP2		1		V
Input source current	$V_O(SCP) = 0$		-15		$\mu\text{A}$

<sup>†</sup> This symbol is not presently listed within EIA/JEDEC standards for semiconductor symbology.

#### oscillator

PARAMETER	TEST CONDITIONS	TL1454Y			UNIT
		MIN	TYP	MAX	
$f_{osc}$ Frequency	$C_T = 120\text{ pF}$ , $R_T = 10\text{ k}\Omega$		500		kHz
Standard deviation of frequency			50		kHz
Frequency change with voltage	$V_{CC} = 3.6\text{ V to }20\text{ V}$		5		kHz
Frequency change with temperature			-2		kHz
			-10		
Maximum ramp voltage			1.8		V
Minimum ramp voltage			1.1		V



**TL1454, TL1454Y**  
**DUAL-CHANNEL PULSE-WIDTH-MODULATION (PWM)**  
**CONTROL CIRCUIT**

SLVS086B – APRIL 1995 – REVISED NOVEMBER 1997

**electrical characteristics,  $V_{CC} = 6\text{ V}$ ,  $f_{osc} = 500\text{ kHz}$ ,  $T_A = 25^\circ\text{C}$  (unless otherwise noted) (continued)**

**dead-time control (DTC)**

PARAMETER	TEST CONDITIONS	TL1454Y			UNIT
		MIN	TYP	MAX	
$V_{IT}$ Input threshold voltage	Duty cycle = 0%	1.1			V
	Duty cycle = 100%	0.5			
$V_{I(latched)}$ Latched-mode input voltage		1.2			V
Latched-mode (source) current		-100			$\mu\text{A}$

**error-amplifier**

PARAMETER	TEST CONDITIONS	TL1454Y			UNIT
		MIN	TYP	MAX	
$I_{IB}$ Input bias current	$V_O = 1.25\text{ V}$ , $V_{IC} = 1.25\text{ V}$	-160			nA
$A_V$ Open-loop voltage gain	$R_{FB} = 200\text{ k}\Omega$	80			dB
Unity-gain bandwidth		3			MHz
CMRR Common-mode rejection ratio		80			dB
$V_{OM(max)}$ Positive output voltage swing		2.43			V
$V_{OM(min)}$ Negative output voltage swing		0.63			
$I_{O+}$ Output sink current	$V_{ID} = -0.1\text{ V}$ , $V_O = 1.20\text{ V}$	0.5			mA
$I_{O-}$ Output source current	$V_{ID} = 0.1\text{ V}$ , $V_O = 1.80\text{ V}$	-70			$\mu\text{A}$

**output**

PARAMETER	TEST CONDITIONS	TL1454Y			UNIT
		MIN	TYP	MAX	
$V_{OH}$ High-level output voltage	$I_O = -8\text{ mA}$	4.5			V
	$I_O = -40\text{ mA}$	4.4			
$V_{OL}$ Low-level output voltage	$I_O = 8\text{ mA}$	0.1			V
	$I_O = 40\text{ mA}$	1.8			
$t_{rv}$ Output voltage rise time	$C_L = 2000\text{ pF}$	220			ns
$t_{fv}$ Output voltage fall time		220			

**supply current**

PARAMETER	TEST CONDITIONS	TL1454Y			UNIT
		MIN	TYP	MAX	
$I_{CC(stby)}$ Standby supply current	RT open, $C_T = 1.5\text{ V}$ , No load, $V_O$ (COMP1, COMP2) = 1.25 V,	3.1			mA
$I_{CC(average)}$ Average supply current	$R_T = 10\text{ k}\Omega$ , $C_T = 120\text{ pF}$ , 50% duty cycle, Outputs open	3.5			mA



**TL1454, TL1454Y**  
**DUAL-CHANNEL PULSE-WIDTH-MODULATION (PWM)**  
**CONTROL CIRCUIT**

SLVS086B – APRIL 1995 – REVISED NOVEMBER 1997

**PARAMETER MEASUREMENT INFORMATION**

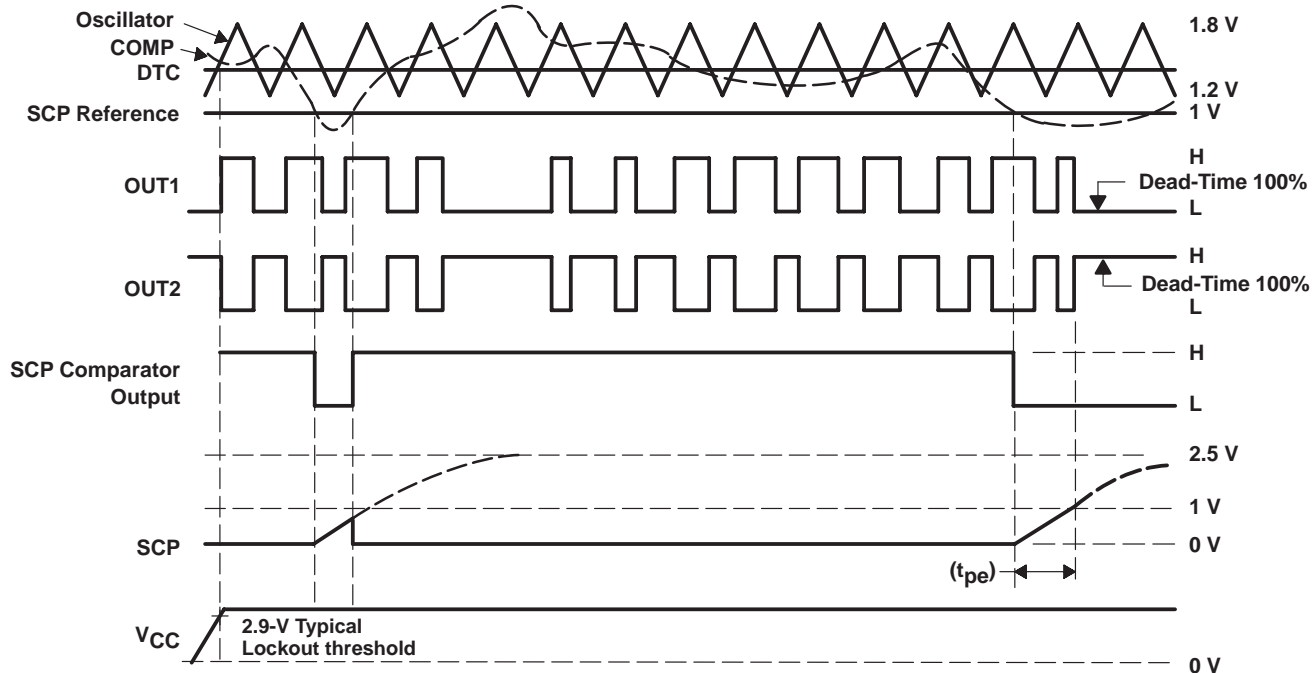

**Figure 5. Timing Diagram**



TYPICAL CHARACTERISTICS

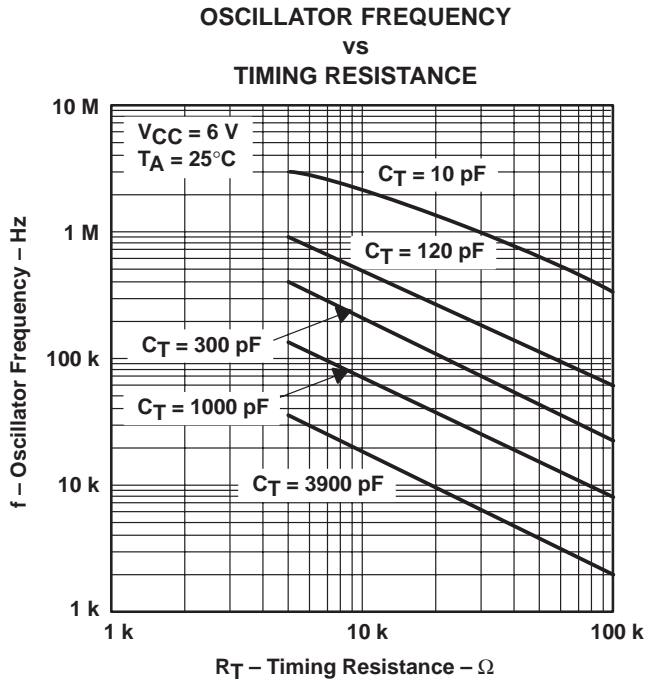

Figure 6

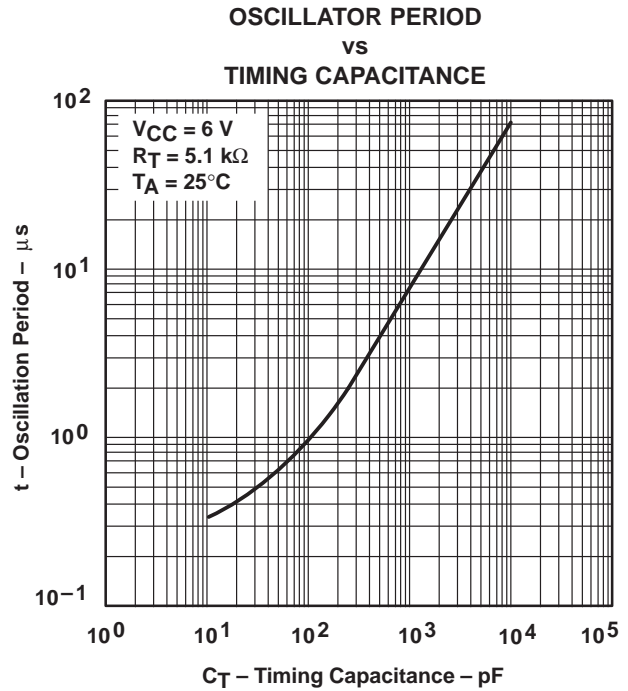

Figure 7

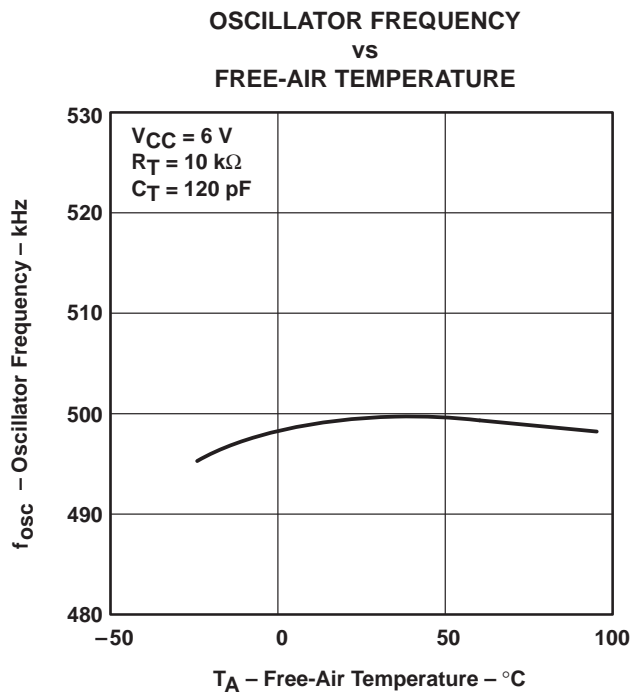

Figure 8

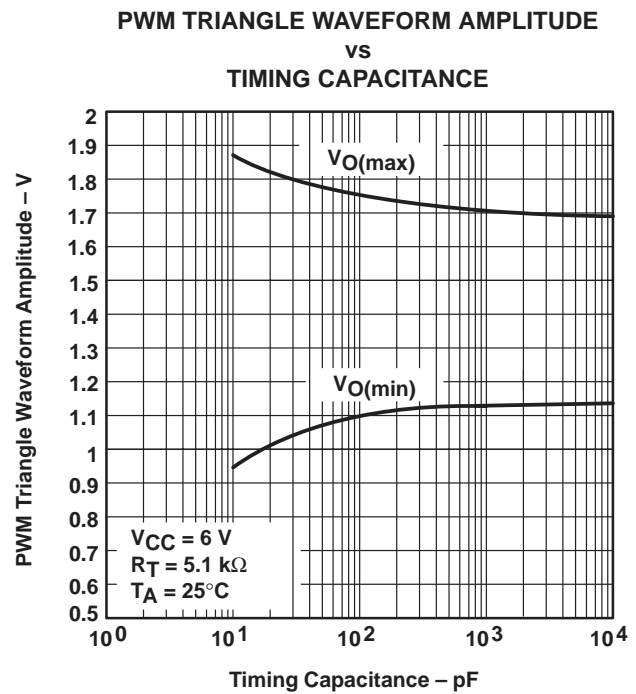
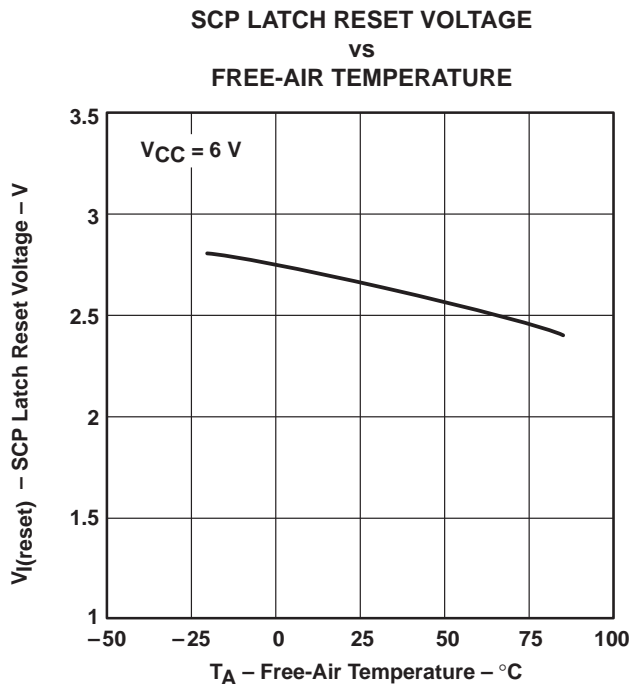
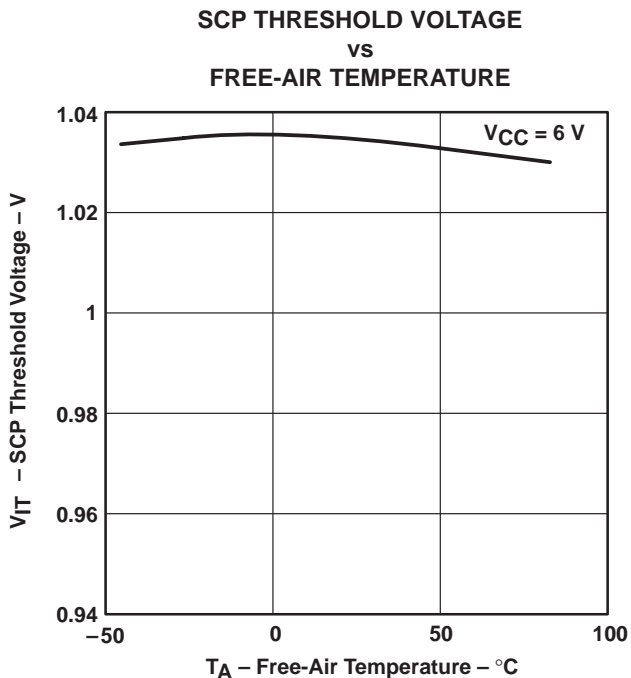
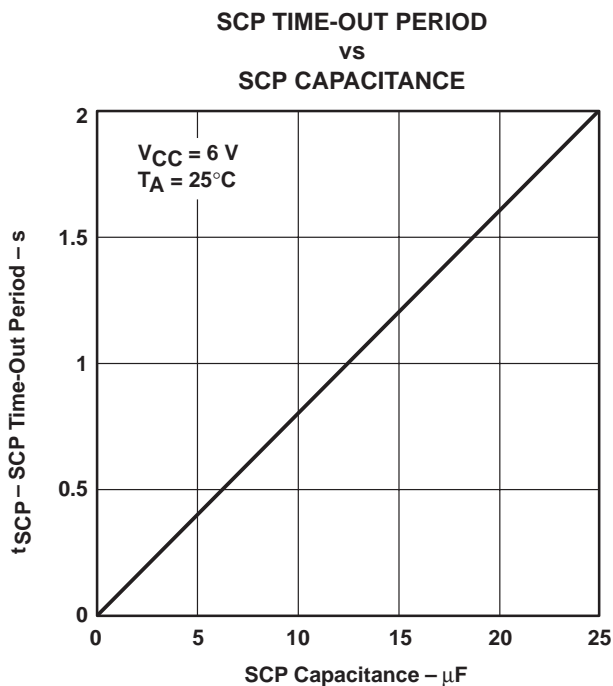
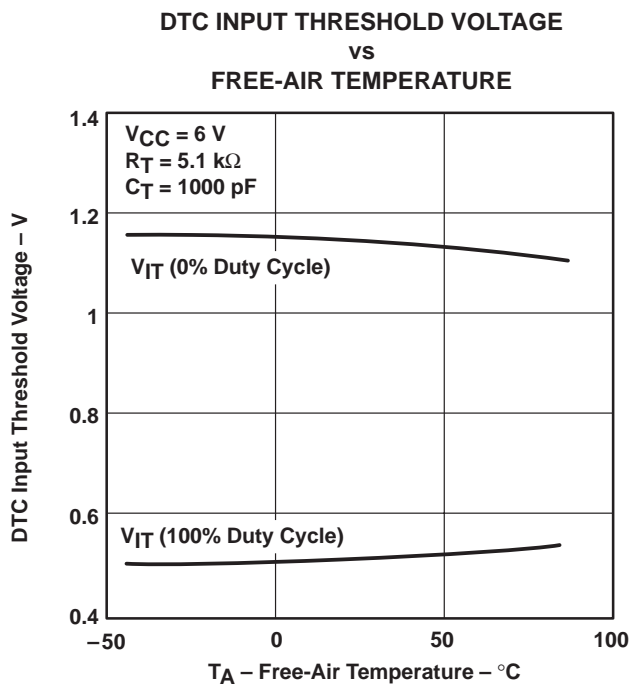

Figure 9

**TL1454, TL1454Y**  
**DUAL-CHANNEL PULSE-WIDTH-MODULATION (PWM)**  
**CONTROL CIRCUIT**

SLVS086B – APRIL 1995 – REVISED NOVEMBER 1997

**TYPICAL CHARACTERISTICS**



TYPICAL CHARACTERISTICS

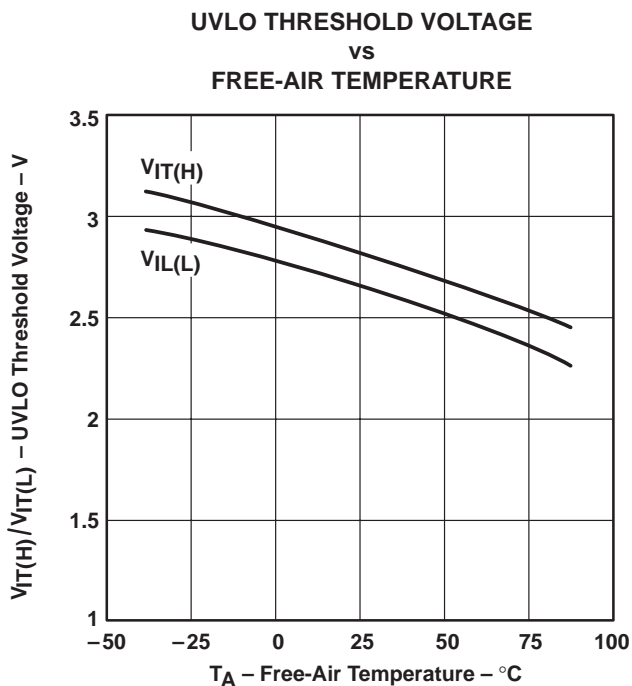

Figure 14

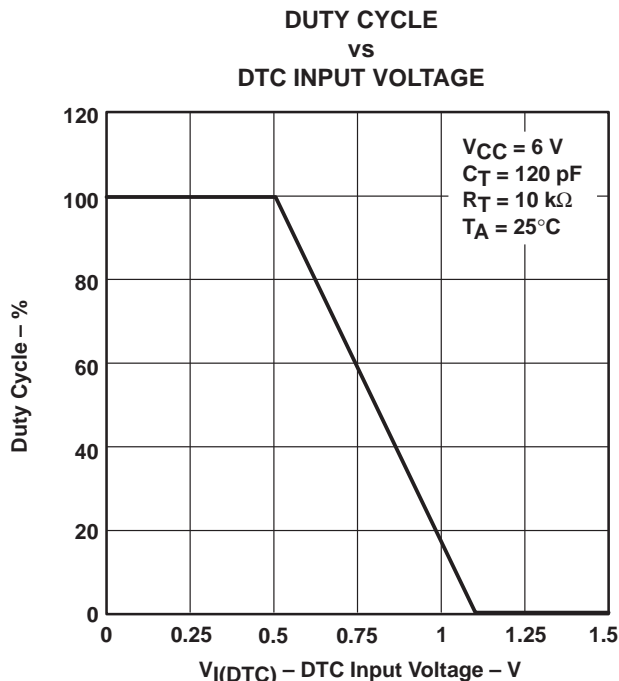

Figure 15

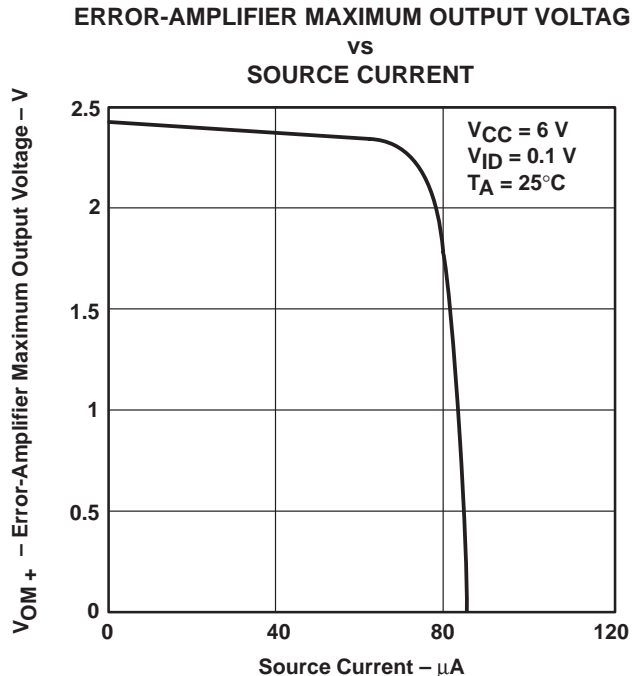

Figure 16

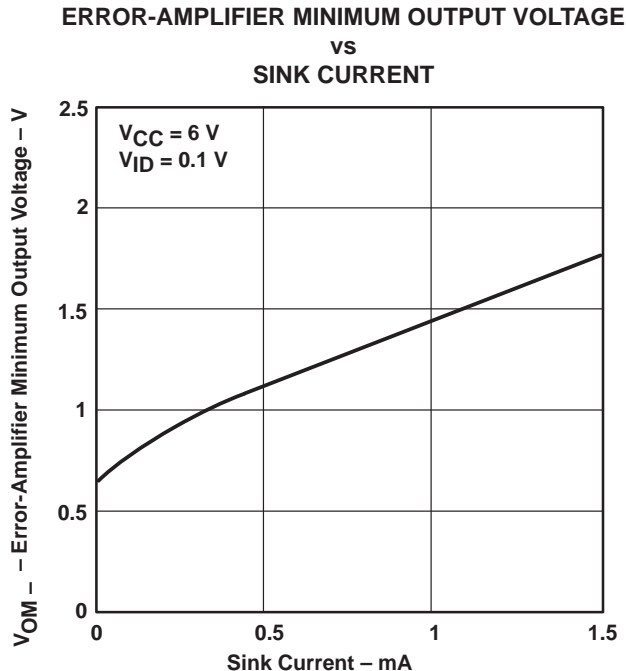

Figure 17

TL1454, TL1454Y  
 DUAL-CHANNEL PULSE-WIDTH-MODULATION (PWM)  
 CONTROL CIRCUIT

SLVS086B – APRIL 1995 – REVISED NOVEMBER 1997

TYPICAL CHARACTERISTICS

ERROR AMPLIFIER MAXIMUM  
 PEAK-TO-PEAK OUTPUT VOLTAGE SWING  
 vs  
 FREQUENCY

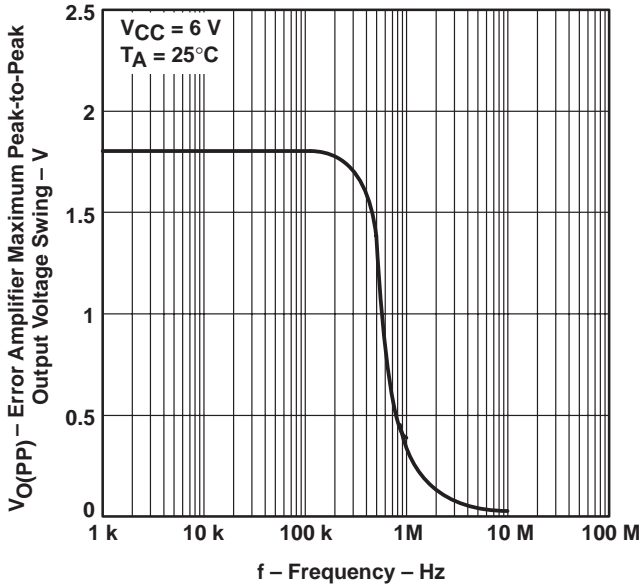

Figure 18

ERROR-AMPLIFIER MINIMUM OUTPUT  
 VOLTAGE SWING  
 vs  
 FREE-AIR TEMPERATURE

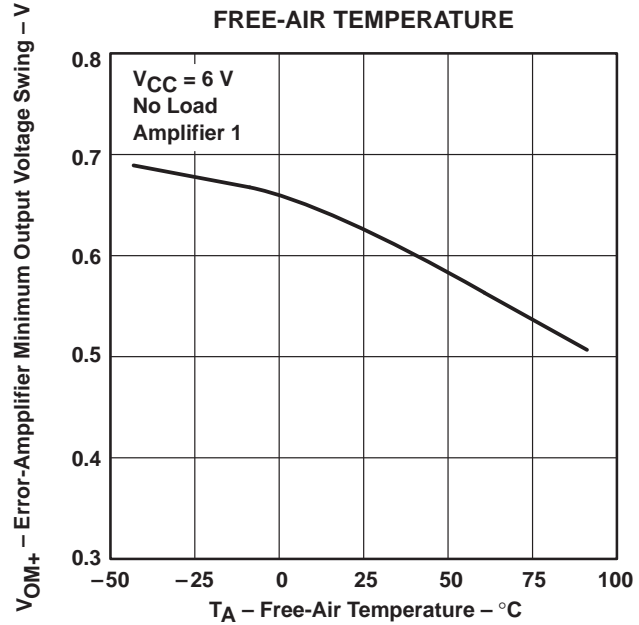

Figure 19

ERROR AMPLIFIER OPEN-LOOP GAIN AND PHASE SHIFT  
 vs  
 FREQUENCY

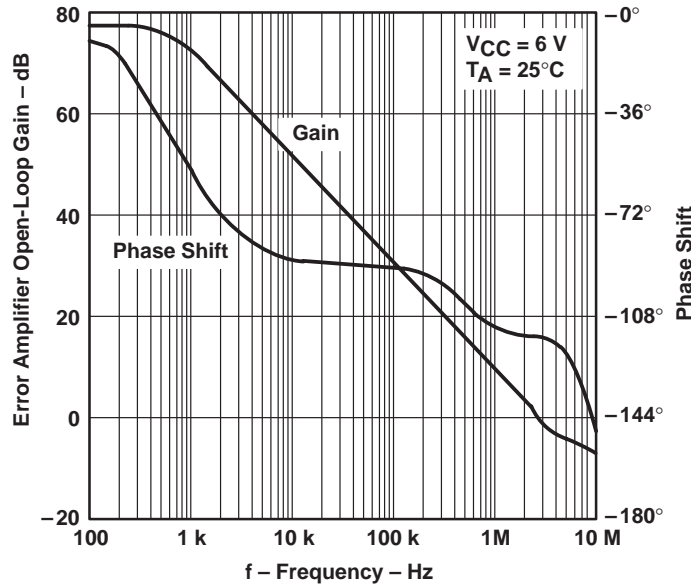

Figure 20





TYPICAL CHARACTERISTICS

ERROR-AMPLIFIER POSITIVE OUTPUT  
 VOLTAGE SWING

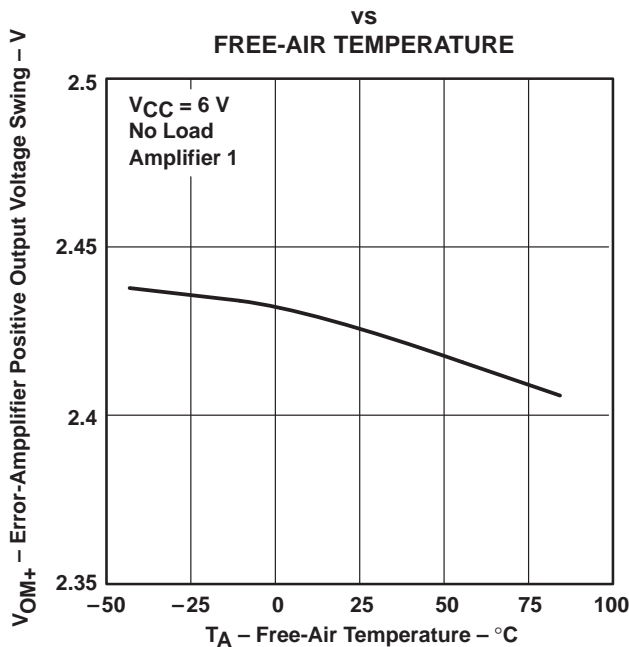

Figure 21

HIGH-LEVEL OUTPUT VOLTAGE  
 vs  
 OUTPUT CURRENT

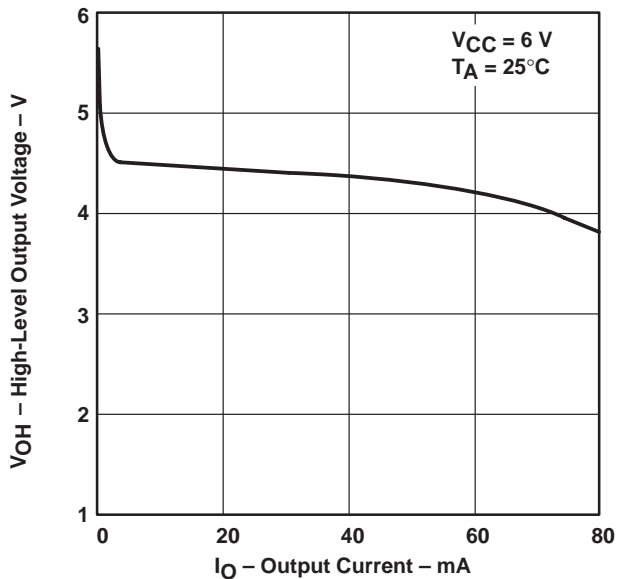

Figure 22

HIGH-LEVEL OUTPUT VOLTAGE  
 vs  
 FREE-AIR TEMPERATURE

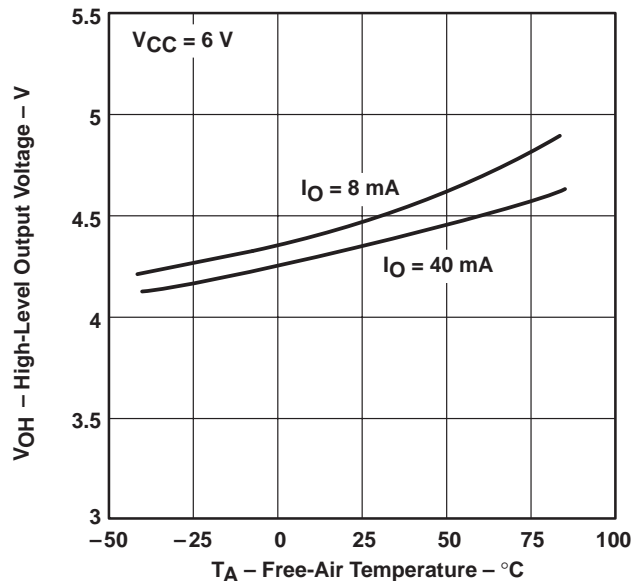

Figure 23

TL1454, TL1454Y  
 DUAL-CHANNEL PULSE-WIDTH-MODULATION (PWM)  
 CONTROL CIRCUIT

SLVS086B – APRIL 1995 – REVISED NOVEMBER 1997

TYPICAL CHARACTERISTICS

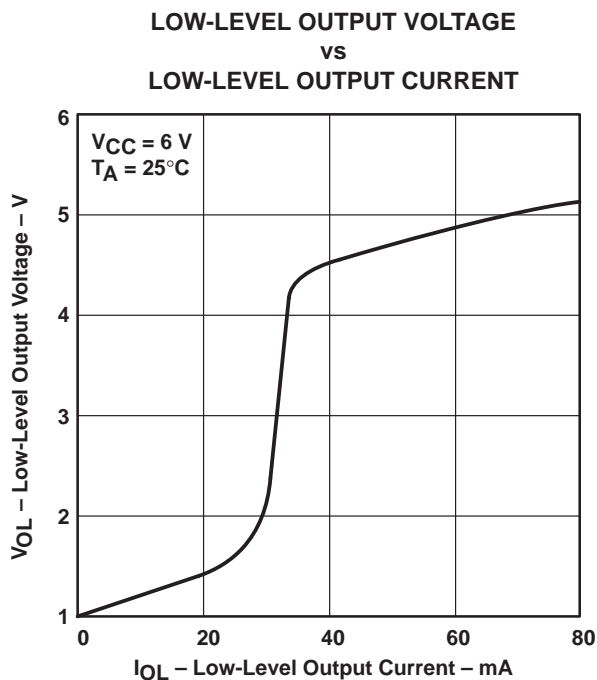

Figure 24

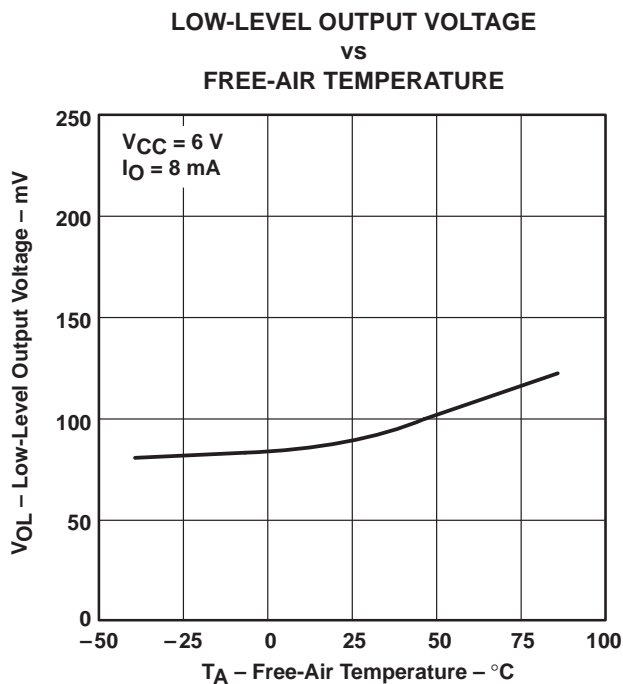

Figure 25

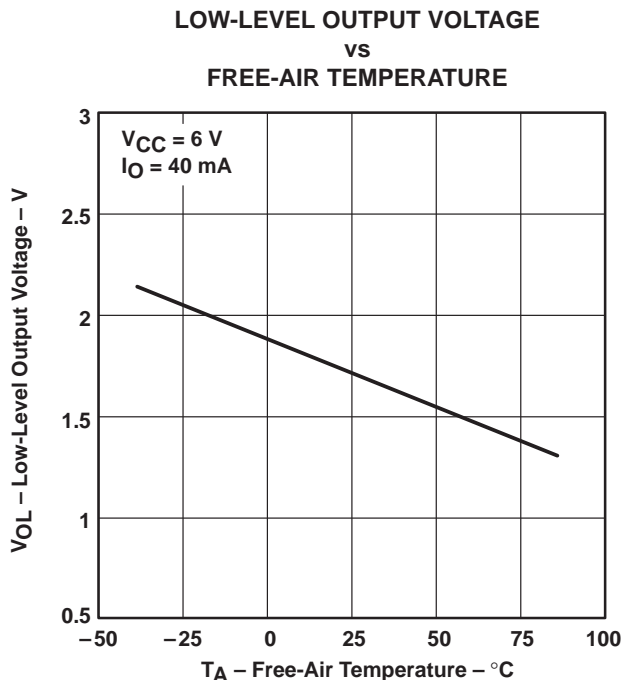

Figure 26

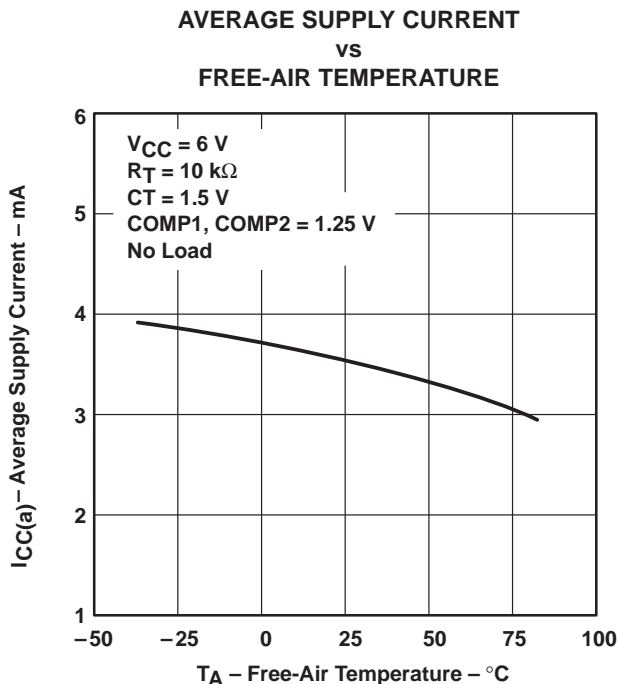

Figure 27



TYPICAL CHARACTERISTICS

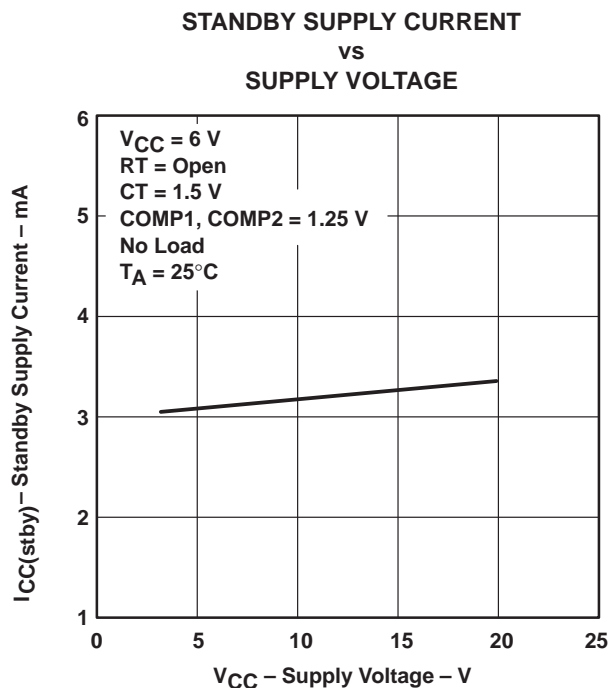

Figure 28

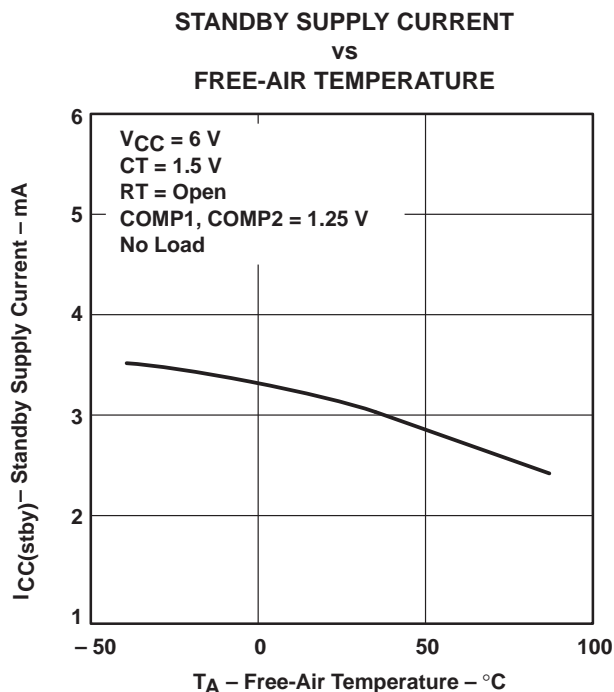

Figure 29

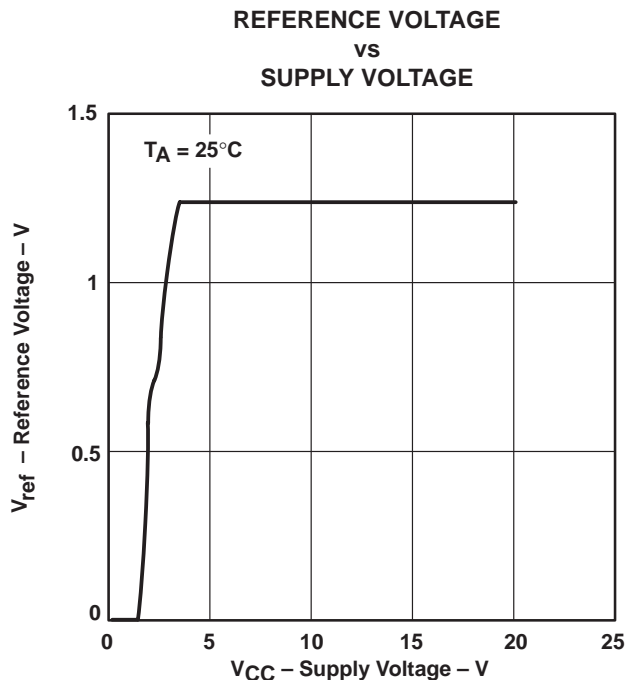

Figure 30

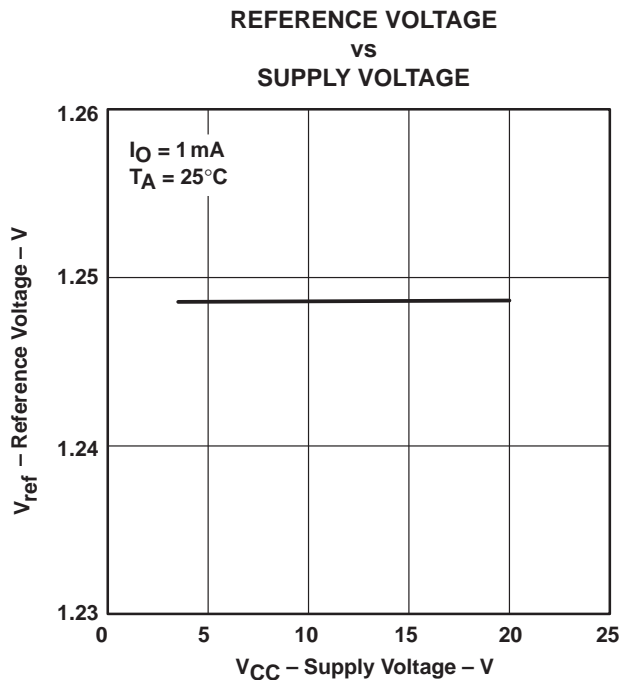

Figure 31

TL1454, TL1454Y  
DUAL-CHANNEL PULSE-WIDTH-MODULATION (PWM)  
CONTROL CIRCUIT

SLVS086B – APRIL 1995 – REVISED NOVEMBER 1997

TYPICAL CHARACTERISTICS

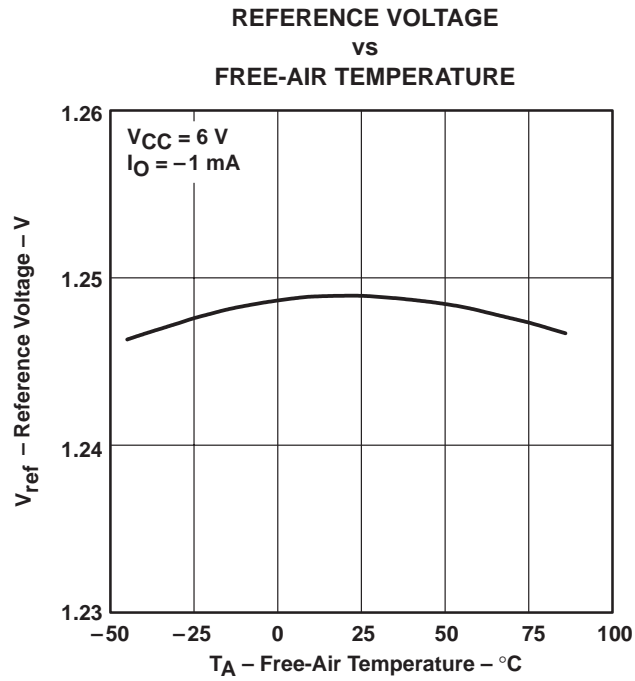

Figure 32

# TL1454, TL1454Y DUAL-CHANNEL PULSE-WIDTH-MODULATION (PWM) CONTROL CIRCUIT

SLVS086B – APRIL 1995 – REVISED NOVEMBER 1997

## MECHANICAL DATA

**D (R-PDSO-G\*\*)**

**PLASTIC SMALL-OUTLINE PACKAGE**

14 PIN SHOWN

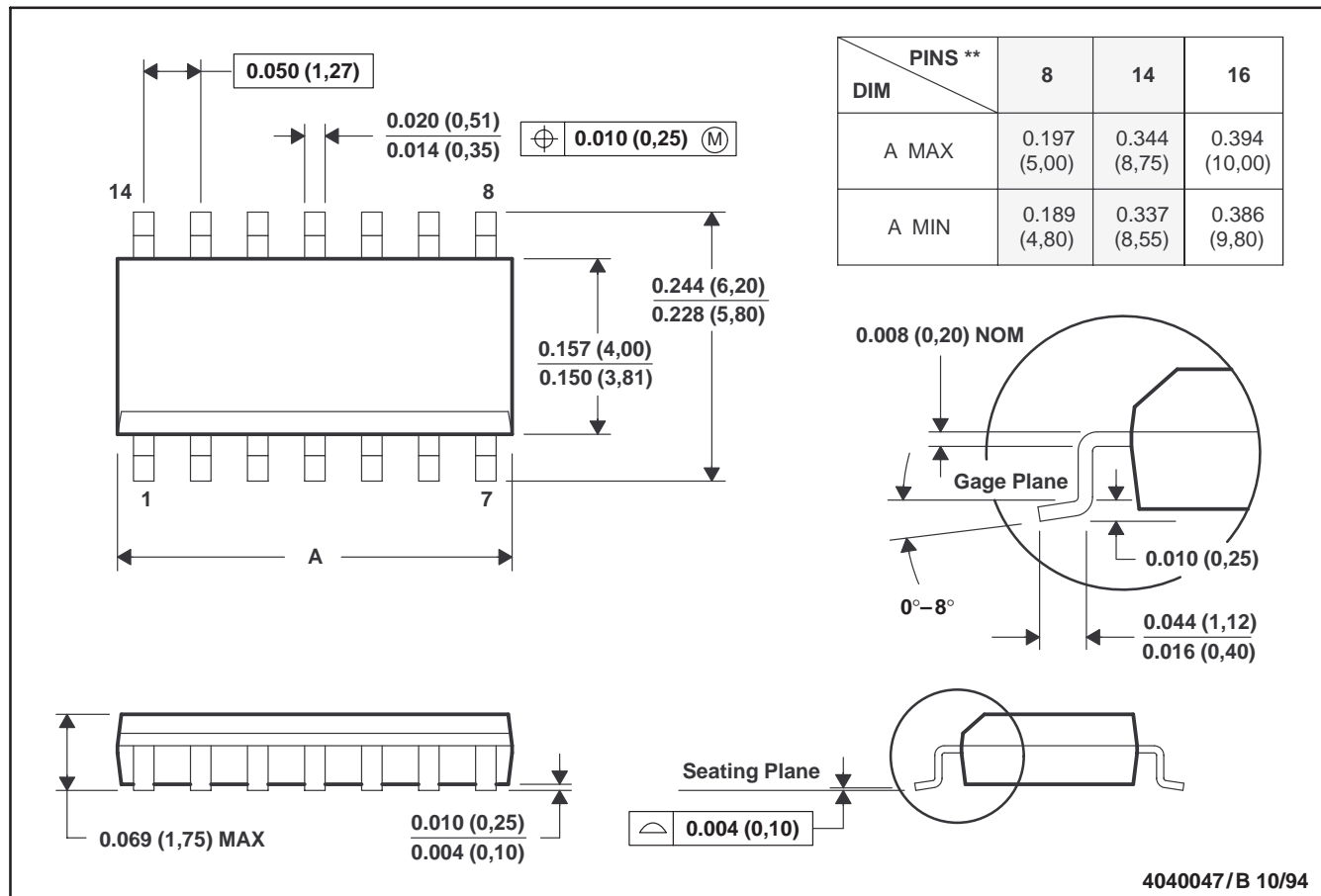

- NOTES: A. All linear dimensions are in inches (millimeters).  
 B. This drawing is subject to change without notice.  
 C. Body dimensions do not include mold flash or protrusion not to exceed 0.006 (0,15).  
 D. Four center pins are connected to die mount pad  
 E. Falls within JEDEC MS-012

# TL1454, TL1454Y DUAL-CHANNEL PULSE-WIDTH-MODULATION (PWM) CONTROL CIRCUIT

SLVS086B – APRIL 1995 – REVISED NOVEMBER 1997

## MECHANICAL DATA

N (R-PDIP-T\*\*)

PLASTIC DUAL-IN-LINE PACKAGE

16 PIN SHOWN

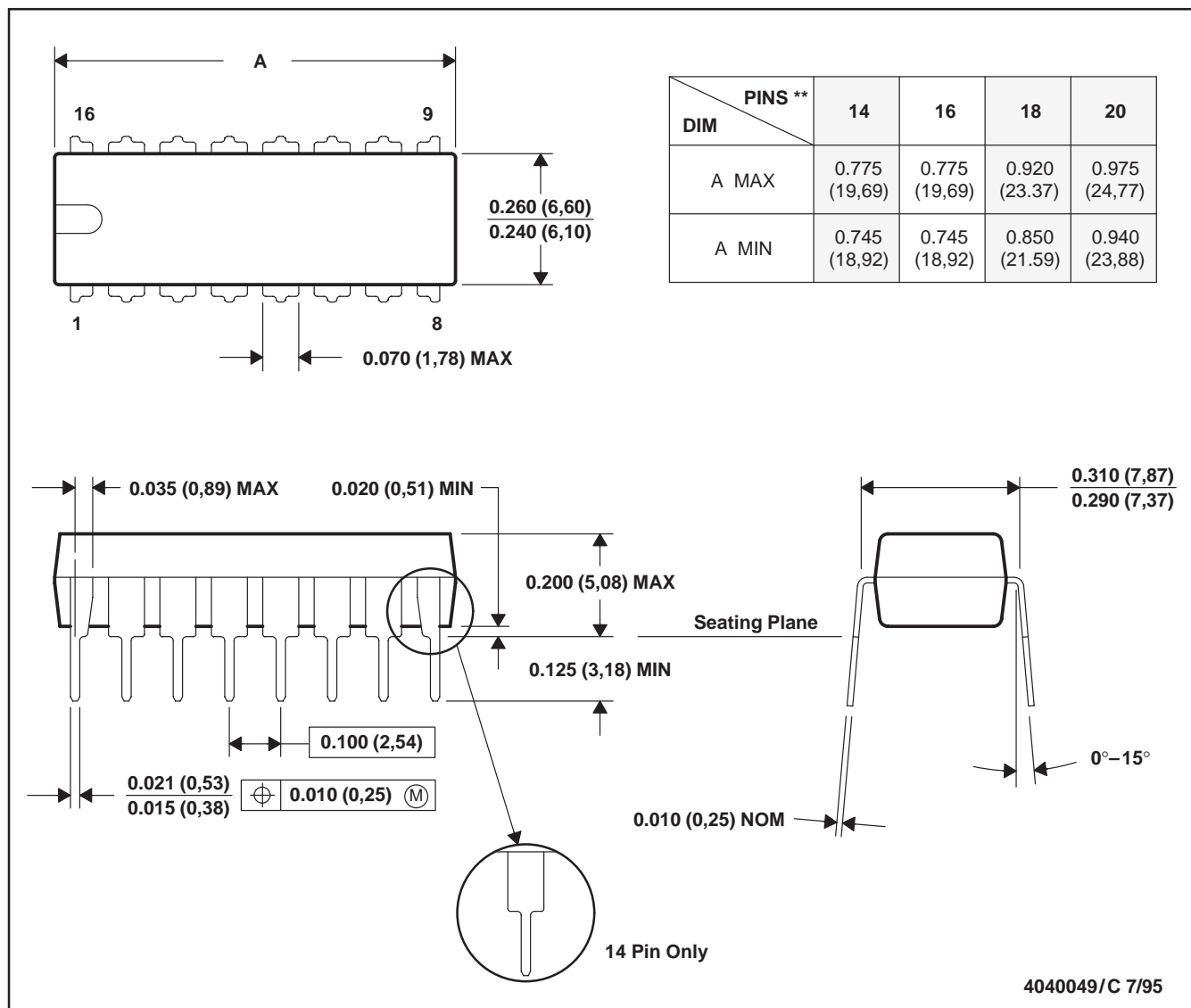

- NOTES: A. All linear dimensions are in inches (millimeters).  
 B. This drawing is subject to change without notice.  
 C. Falls within JEDEC MS-001 (20-pin package is shorter than MS-001)



TL1454, TL1454Y  
**DUAL-CHANNEL PULSE-WIDTH-MODULATION (PWM)  
CONTROL CIRCUIT**

SLVS086B – APRIL 1995 – REVISED NOVEMBER 1997

**MECHANICAL DATA**

**PW (R-PDSO-G\*\*)**

**PLASTIC SMALL-OUTLINE PACKAGE**

14 PIN SHOWN

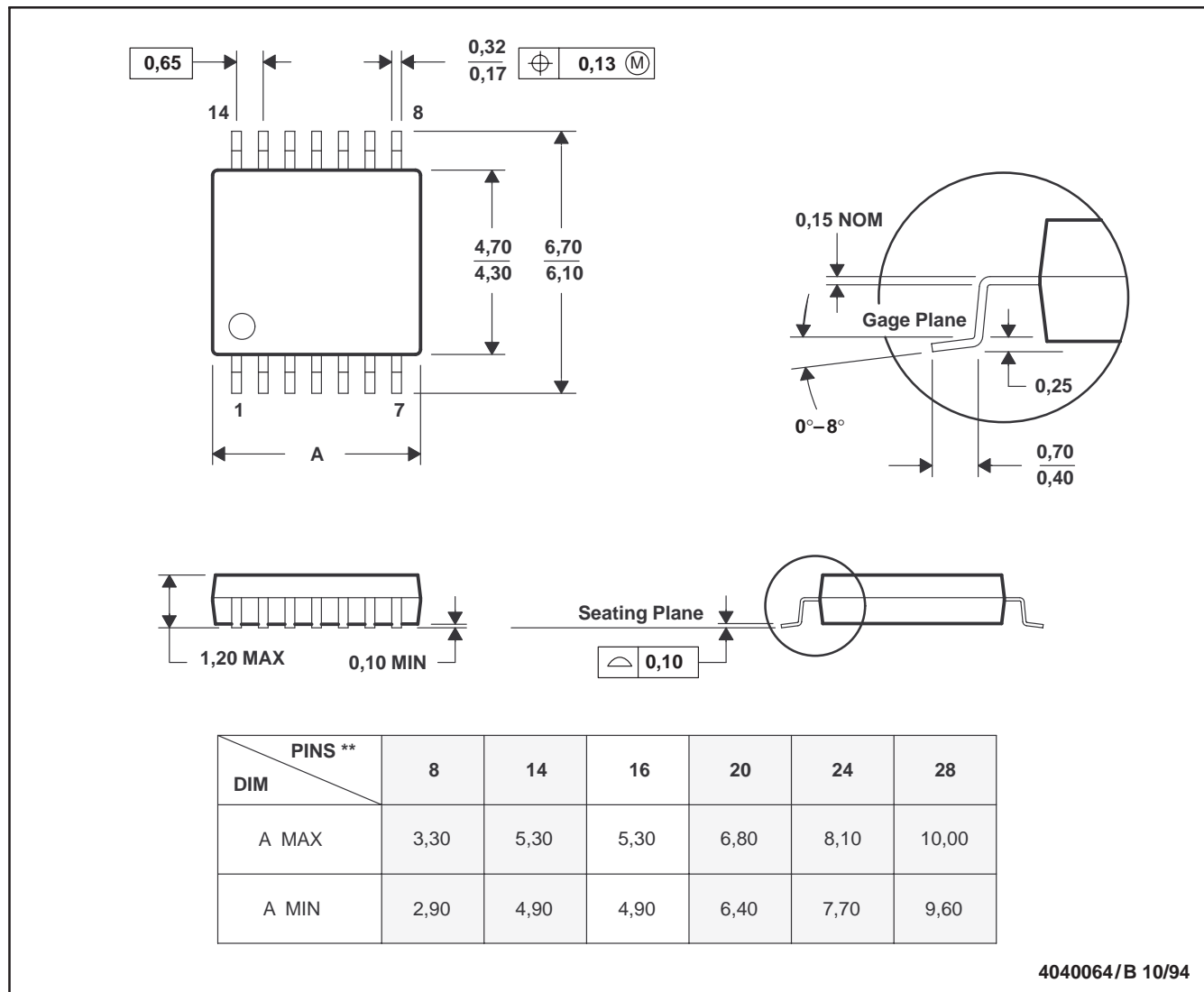

4040064/B 10/94

- NOTES: A. All linear dimensions are in millimeters.  
 B. This drawing is subject to change without notice.  
 C. Body dimensions do not include mold flash or protrusion not to exceed 0,15.



**PACKAGING INFORMATION**

Orderable Device	Status <sup>(1)</sup>	Package Type	Package Drawing	Pins	Package Qty	Eco Plan <sup>(2)</sup>	Lead/Ball Finish	MSL Peak Temp <sup>(3)</sup>
TL1454CD	OBSOLETE	SOIC	D	16		TBD	Call TI	Call TI
TL1454CDR	OBSOLETE	SOIC	D	16		TBD	Call TI	Call TI
TL1454CN	OBSOLETE	PDIP	N	16		TBD	Call TI	Call TI
TL1454CNSR	OBSOLETE	SO	NS	16		TBD	Call TI	Call TI
TL1454CPWLE	OBSOLETE	TSSOP	PW	16		TBD	Call TI	Call TI
TL1454CPWR	OBSOLETE	TSSOP	PW	16		TBD	Call TI	Call TI
TL1454ID	OBSOLETE	SOIC	D	16		TBD	Call TI	Call TI
TL1454IDR	OBSOLETE	SOIC	D	16		TBD	Call TI	Call TI

<sup>(1)</sup> The marketing status values are defined as follows:

**ACTIVE:** Product device recommended for new designs.

**LIFEBUY:** TI has announced that the device will be discontinued, and a lifetime-buy period is in effect.

**NRND:** Not recommended for new designs. Device is in production to support existing customers, but TI does not recommend using this part in a new design.

**PREVIEW:** Device has been announced but is not in production. Samples may or may not be available.

**OBSOLETE:** TI has discontinued the production of the device.

<sup>(2)</sup> Eco Plan - The planned eco-friendly classification: Pb-Free (RoHS) or Green (RoHS & no Sb/Br) - please check <http://www.ti.com/productcontent> for the latest availability information and additional product content details.

**TBD:** The Pb-Free/Green conversion plan has not been defined.

**Pb-Free (RoHS):** TI's terms "Lead-Free" or "Pb-Free" mean semiconductor products that are compatible with the current RoHS requirements for all 6 substances, including the requirement that lead not exceed 0.1% by weight in homogeneous materials. Where designed to be soldered at high temperatures, TI Pb-Free products are suitable for use in specified lead-free processes.

**Green (RoHS & no Sb/Br):** TI defines "Green" to mean Pb-Free (RoHS compatible), and free of Bromine (Br) and Antimony (Sb) based flame retardants (Br or Sb do not exceed 0.1% by weight in homogeneous material)

<sup>(3)</sup> MSL, Peak Temp. -- The Moisture Sensitivity Level rating according to the JEDEC industry standard classifications, and peak solder temperature.

**Important Information and Disclaimer:**The information provided on this page represents TI's knowledge and belief as of the date that it is provided. TI bases its knowledge and belief on information provided by third parties, and makes no representation or warranty as to the accuracy of such information. Efforts are underway to better integrate information from third parties. TI has taken and continues to take reasonable steps to provide representative and accurate information but may not have conducted destructive testing or chemical analysis on incoming materials and chemicals. TI and TI suppliers consider certain information to be proprietary, and thus CAS numbers and other limited information may not be available for release.

In no event shall TI's liability arising out of such information exceed the total purchase price of the TI part(s) at issue in this document sold by TI to Customer on an annual basis.



## IMPORTANT NOTICE

Texas Instruments Incorporated and its subsidiaries (TI) reserve the right to make corrections, modifications, enhancements, improvements, and other changes to its products and services at any time and to discontinue any product or service without notice. Customers should obtain the latest relevant information before placing orders and should verify that such information is current and complete. All products are sold subject to TI's terms and conditions of sale supplied at the time of order acknowledgment.

TI warrants performance of its hardware products to the specifications applicable at the time of sale in accordance with TI's standard warranty. Testing and other quality control techniques are used to the extent TI deems necessary to support this warranty. Except where mandated by government requirements, testing of all parameters of each product is not necessarily performed.

TI assumes no liability for applications assistance or customer product design. Customers are responsible for their products and applications using TI components. To minimize the risks associated with customer products and applications, customers should provide adequate design and operating safeguards.

TI does not warrant or represent that any license, either express or implied, is granted under any TI patent right, copyright, mask work right, or other TI intellectual property right relating to any combination, machine, or process in which TI products or services are used. Information published by TI regarding third-party products or services does not constitute a license from TI to use such products or services or a warranty or endorsement thereof. Use of such information may require a license from a third party under the patents or other intellectual property of the third party, or a license from TI under the patents or other intellectual property of TI.

Reproduction of information in TI data books or data sheets is permissible only if reproduction is without alteration and is accompanied by all associated warranties, conditions, limitations, and notices. Reproduction of this information with alteration is an unfair and deceptive business practice. TI is not responsible or liable for such altered documentation.

Resale of TI products or services with statements different from or beyond the parameters stated by TI for that product or service voids all express and any implied warranties for the associated TI product or service and is an unfair and deceptive business practice. TI is not responsible or liable for any such statements.

Following are URLs where you can obtain information on other Texas Instruments products and application solutions:

<b>Products</b>		<b>Applications</b>	
Amplifiers	<a href="http://amplifier.ti.com">amplifier.ti.com</a>	Audio	<a href="http://www.ti.com/audio">www.ti.com/audio</a>
Data Converters	<a href="http://dataconverter.ti.com">dataconverter.ti.com</a>	Automotive	<a href="http://www.ti.com/automotive">www.ti.com/automotive</a>
DSP	<a href="http://dsp.ti.com">dsp.ti.com</a>	Broadband	<a href="http://www.ti.com/broadband">www.ti.com/broadband</a>
Interface	<a href="http://interface.ti.com">interface.ti.com</a>	Digital Control	<a href="http://www.ti.com/digitalcontrol">www.ti.com/digitalcontrol</a>
Logic	<a href="http://logic.ti.com">logic.ti.com</a>	Military	<a href="http://www.ti.com/military">www.ti.com/military</a>
Power Mgmt	<a href="http://power.ti.com">power.ti.com</a>	Optical Networking	<a href="http://www.ti.com/opticalnetwork">www.ti.com/opticalnetwork</a>
Microcontrollers	<a href="http://microcontroller.ti.com">microcontroller.ti.com</a>	Security	<a href="http://www.ti.com/security">www.ti.com/security</a>
		Telephony	<a href="http://www.ti.com/telephony">www.ti.com/telephony</a>
		Video & Imaging	<a href="http://www.ti.com/video">www.ti.com/video</a>
		Wireless	<a href="http://www.ti.com/wireless">www.ti.com/wireless</a>

Mailing Address: Texas Instruments  
Post Office Box 655303 Dallas, Texas 75265