



2.7V TO 5.5V LOW-POWER DUAL 10-BIT DIGITAL-TO-ANALOG CONVERTER WITH INTERNAL REFERENCE AND POWER DOWN

FEATURES

- Dual 10-Bit Voltage Output DAC
- Programmable Internal Reference
- Programmable Settling Time:
 - 0.8 μ s in Fast Mode
 - 2.8 μ s in Slow Mode
- Compatible With TMS320 and SPI™ Serial Ports
- Differential Nonlinearity <0.1LSB Typ
- Monotonic Over Temperature

APPLICATIONS

- Digital Servo Control Loops
- Digital Offset and Gain Adjustment
- Industrial Process Control
- Machine and Motion Control Devices
- Mass Storage Devices

DESCRIPTION

The TLV5637 is a dual 10-bit voltage output DAC with a flexible 3-wire serial interface. The serial interface allows glueless interface to TMS320 and SPI™, QSPI™, and Microwire™ serial ports. It is programmed with a 16-bit serial string containing 2 control and 10 data bits.

The resistor string output voltage is buffered by a x2 gain rail-to-rail output buffer. The buffer features a Class AB output stage to improve stability and reduce settling time. The programmable settling time of the DAC allows the designer to optimize speed versus power dissipation. With its on-chip programmable precision voltage reference, the TLV5637 simplifies overall system design.

Because of its ability to source up to 1mA, the reference can also be used as a system reference. Implemented with a CMOS process, the device is designed for single supply operation from 2.7V to 5.5V. It is available in an 8-pin SOIC package to reduce board space in standard commercial and industrial temperature ranges.

D PACKAGE
(TOP VIEW)

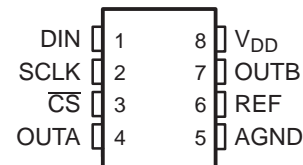

Please be aware that an important notice concerning availability, standard warranty, and use in critical applications of Texas Instruments semiconductor products and disclaimers thereto appears at the end of this data sheet.

SPI, QSPI are trademarks of Motorola, Inc.
Microwire is a trademark of National Semiconductor Corporation.
All other trademarks are the property of their respective owners.



These devices have limited built-in ESD protection. The leads should be shorted together or the device placed in conductive foam during storage or handling to prevent electrostatic damage to the MOS gates.

FUNCTIONAL BLOCK DIAGRAM

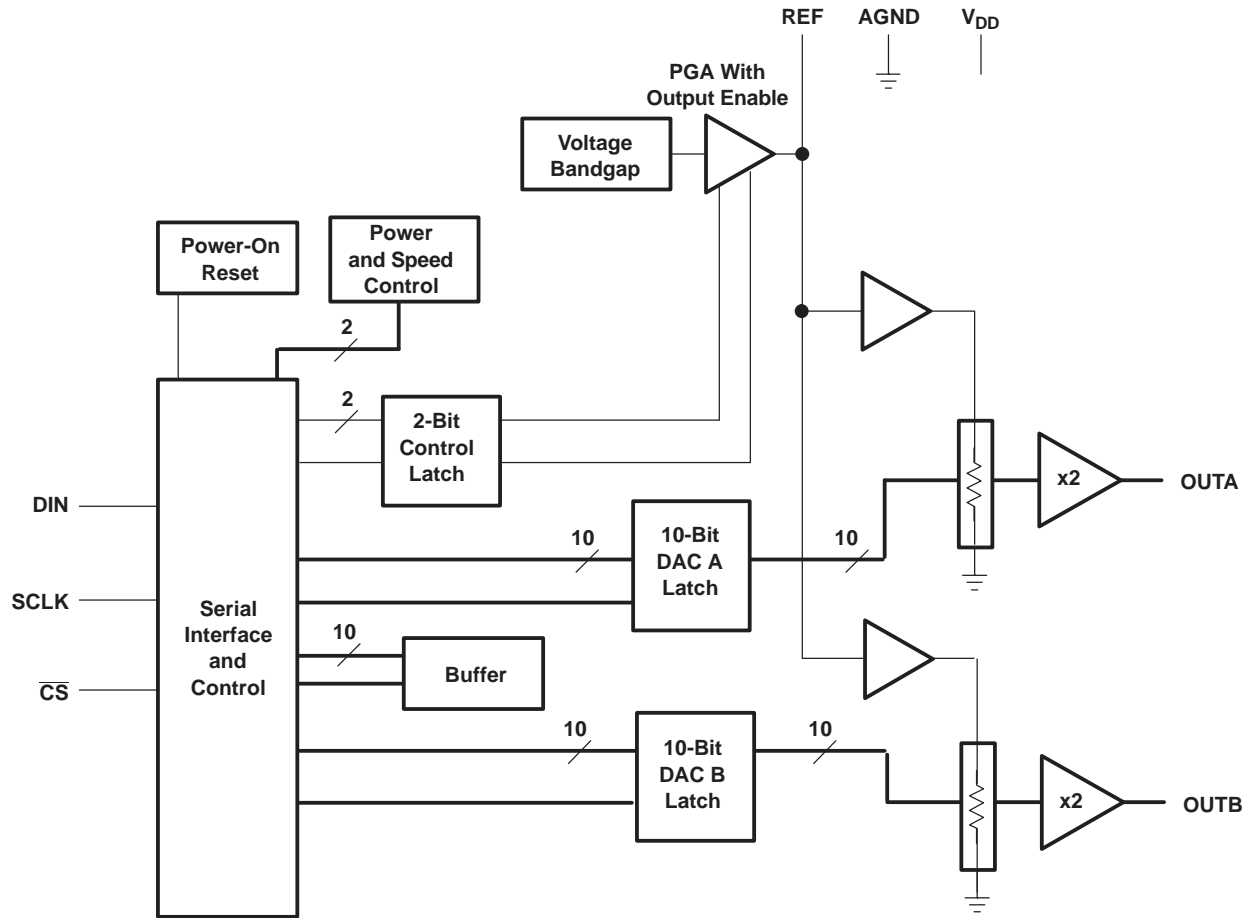

Terminal Functions

TERMINAL NAME	NO.	I/O/P	DESCRIPTION
AGND	5	P	Ground
\overline{CS}	3	I	Chip select. Digital input active low, used to enable/disable inputs
DIN	1	I	Digital serial data input
OUTA	4	I	DAC A analog voltage output
OUTB	7	O	DAC B analog voltage output
REF	6	I/O	Analog reference voltage input/output
SCLK	2	I	Digital serial clock input
V_{DD}	8	P	Positive power supply

ABSOLUTE MAXIMUM RATINGS⁽¹⁾

Over operating free-air temperature range (unless otherwise noted).

		UNIT
Supply voltage (V_{DD} to AGND)		7V
Reference input voltage range		-0.3 V to $V_{DD} + 0.3V$
Digital input voltage range		-0.3 V to $V_{DD} + 0.3V$
Operating free-air temperature range, T_A	TLV5637C	0°C to +70°C
	TLV5637I	-40°C to +85°C
Storage temperature range, T_{stg}		-65°C to +150°C
Lead temperature 1,6mm (1/16 inch) from case for 10 seconds		+260°C

- (1) Stresses beyond those listed under [Absolute Maximum Ratings](#) may cause permanent damage to the device. These are stress ratings only, and functional operation of the device at these or any other conditions beyond those indicated under [Recommended Operating Conditions](#) is not implied. Exposure to absolute-maximum-rated conditions for extended periods may affect device reliability.

PACKAGE/ORDERING INFORMATION

For the most current package and ordering information, see the Package Option Addendum at the end of this document, or see the TI website at www.ti.com.

RECOMMENDED OPERATING CONDITIONS

		MIN	NOM	MAX	UNIT
Supply voltage, V_{DD}	$V_{DD} = 5 V$	4.5	5	5.5	V
	$V_{DD} = 3 V$	2.7	3	3.3	V
Power on threshold voltage, POR		0.55		2	V
High-level digital input voltage, V_{IH}	$DV_{DD} = 2.7 V$	2			V
	$DV_{DD} = 5.5 V$	2.4			
Low-level digital input voltage, V_{IL}	$DV_{DD} = 2.7 V$			0.6	V
	$DV_{DD} = 5.5 V$			1	
Reference voltage, V_{ref} to REF terminal	$V_{DD} = 5 V$ (see ⁽¹⁾)	AGND	2.048	$V_{DD}-1.5$	V
Reference voltage, V_{ref} to REF terminal	$V_{DD} = 3 V$ (see ⁽¹⁾)	AGND	1.024	$V_{DD}-1.5$	V
Load resistance, R_L		2			k Ω
Load capacitance, C_L				100	pF
Clock frequency, f_{CLK}				20	MHz
Operating free-air temperature, T_A	TLV5637C	0		+70	°C
	TLV5637I	-40		+85	

- (1) Due to the x2 output buffer, a reference input voltage $\geq (V_{DD} - 0.4V)/2$ causes clipping of the transfer function. The output buffer of the internal reference must be disabled, if an external reference is used.

ELECTRICAL CHARACTERISTICS

Over recommended operating conditions (unless otherwise noted).

POWER SUPPLY							
PARAMETER		TEST CONDITIONS		MIN	TYP	MAX	UNIT
I _{DD}	Power supply current	No load, All inputs = AGND or V _{DD} , DAC latch = 0x800	V _{DD} = 5V, Int. ref.	Fast	4.2	7	mA
				Slow	2	3.6	mA
			V _{DD} = 3V, Int. ref.	Fast	3.7	6.3	mA
				Slow	1.7	3.0	mA
			V _{DD} = 5V, Ext. ref.	Fast	3.8	6.3	mA
				Slow	1.7	3.0	mA
			V _{DD} = 3V, Ext. ref.	Fast	3.4	5.7	mA
				Slow	1.4	2.6	mA
Power-down supply current				0.01	10	μA	
PSRR	Power supply rejection ratio	Zero scale, See (1)		65		dB	
		Full scale, See (2)		65			

(1) Power supply rejection ratio at zero scale is measured by varying V_{DD} and is given by: $PSRR = 20 \log [(E_{ZS}(V_{DDmax}) - E_{ZS}(V_{DDmin})) / V_{DDmax}]$

(2) Power supply rejection ratio at full scale is measured by varying V_{DD} and is given by: $PSRR = 20 \log [(E_G(V_{DDmax}) - E_G(V_{DDmin})) / V_{DDmax}]$

STATIC DAC SPECIFICATIONS							
PARAMETER		TEST CONDITIONS		MIN	TYP	MAX	UNIT
Resolution				10			bits
INL	Integral nonlinearity, end point adjusted	See (1)		±0.4		±1	LSB
DNL	Differential nonlinearity	See (2)		±0.1		±0.5	LSB
E _{ZS}	Zero-scale error (offset error at zero scale)	See (3)				±24	mV
E _{ZS} TC	Zero-scale-error temperature coefficient	See (4)			10		ppm/°C
E _G	Gain error	See (5)				±0.6	% full scale V
E _G TC	Gain error temperature coefficient	See (6)			10		ppm/°C
OUTPUT SPECIFICATIONS							
V _O	Output voltage	R _L = 10kΩ		0		V _{DD} -0.4	V
Output load regulation accuracy		V _O = 4.096V, 2.048V, R _L = 2 kΩ				±0.25	% full scale V

(1) The relative accuracy or integral nonlinearity (INL) sometimes referred to as linearity error, is the maximum deviation of the output from the line between zero and full scale excluding the effects of zero code and full-scale errors. Tested from code 32 to 4095.

(2) The differential nonlinearity (DNL) sometimes referred to as differential error, is the difference between the measured and ideal 1 LSB amplitude change of any two adjacent codes. Monotonic means the output voltage changes in the same direction (or remains constant) as a change in the digital input code.

(3) Zero-scale error is the deviation from zero voltage output when the digital input code is zero.

(4) Zero-scale-error temperature coefficient is given by: $E_{ZS} TC = [E_{ZS}(T_{max}) - E_{ZS}(T_{min})] / V_{ref} \times 10^6 / (T_{max} - T_{min})$.

(5) Gain error is the deviation from the ideal output (2V_{ref} - 1LSB) with an output load of 10 k excluding the effects of the zero-error.

(6) Gain temperature coefficient is given by: $E_G TC = [E_G(T_{max}) - E_G(T_{min})] / V_{ref} \times 10^6 / (T_{max} - T_{min})$.

ELECTRICAL CHARACTERISTICS (Continued)

over recommended operating conditions (unless otherwise noted)

REFERENCE PIN CONFIGURED AS OUTPUT (REF)						
PARAMETER		TEST CONDITIONS	MIN	TYP	MAX	UNIT
$V_{\text{ref(OUTL)}}$	Low reference voltage		1.003	1.024	1.045	V
$V_{\text{ref(OUTH)}}$	High reference voltage	$V_{\text{DD}} > 4.75\text{V}$	2.027	2.048	2.069	V
$I_{\text{ref(source)}}$	Output source current				1	mA
$I_{\text{ref(sink)}}$	Output sink current		1			mA
	Load capacitance				100	pF
PSRR	Power supply rejection ratio			65		dB

REFERENCE PIN CONFIGURED AS INPUT (REF)						
PARAMETER		TEST CONDITIONS	MIN	TYP	MAX	UNIT
V_{I}	Input voltage		0		$V_{\text{DD}} - 1.5$	V
R_{I}	Input resistance			10		M Ω
C_{I}	Input capacitance			5		pF
	Reference input bandwidth	REF = $0.2V_{\text{PP}} + 1.024\text{V}$ dc		Fast Slow	1.3 525	MHz kHz
	Reference feedthrough	REF = $1V_{\text{PP}}$ at 1 kHz + 1.024V dc, See ⁽¹⁾			80	dB

(1) Reference feedthrough is measured at the DAC output with an input code = 0x000.

DIGITAL INPUTS						
PARAMETER		TEST CONDITIONS	MIN	TYP	MAX	UNIT
I_{IH}	High-level digital input current	$V_{\text{I}} = V_{\text{DD}}$			1	μA
I_{IL}	Low-level digital input current	$V_{\text{I}} = 0\text{V}$	1			μA
C_{i}	Input capacitance			8		pF

ELECTRICAL CHARACTERISTICS (CONTINUED)

over recommended operating conditions (unless otherwise noted)

ANALOG OUTPUT DYNAMIC PERFORMANCE							
PARAMETER		TEST CONDITIONS		MIN	TYP	MAX	UNIT
$t_{s(FS)}$	Output settling time, full scale	$R_L = 10k\Omega, C_L = 100pF,$	See (1)	Fast	0.8	2.4	μs
				Slow	2.8	5.5	
$t_{s(CC)}$	Output settling time, code to code	$R_L = 10k\Omega, C_L = 100pF,$	See (2)	Fast	0.4	1.2	μs
				Slow	0.8	1.6	
SR	Slew rate	$R_L = 10k\Omega, C_L = 100pF,$	See (3)	Fast	12		V/ μs
				Slow	1.8		
	Glitch energy	$DIN = 0$ to $1, f_{CLK} = 100kHz,$	$\overline{CS} = V_{DD}$		5		nV-S
SNR	Signal-to-noise ratio	$f_s = 480kSPS, f_{out} = 1kHz, R_L = 10k\Omega, C_L = 100pF$		53	56		dB
S/(N+D)	Signal-to-noise + distortion			50	54		
THD	Total harmonic distortion			61	50		
SFDR	Spurious free dynamic range			51	62		

- (1) Settling time is the time for the output signal to remain within $\pm 0.5LSB$ of the final measured value for a digital input code change of 0x020 to 0xFDF or 0xFDF to 0x020 respectively. Not tested, assured by design.
- (2) Settling time is the time for the output signal to remain within $\pm 0.5LSB$ of the final measured value for a digital input code change of one count. Not tested, assured by design.
- (3) Slew rate determines the time it takes for a change of the DAC output from 10% to 90% full-scale voltage.

DIGITAL INPUT TIMING REQUIREMENTS

		MIN	NOM	MAX	UNIT
$t_{su(CS-CK)}$	Setup time, \overline{CS} low before first negative SCLK edge	10			ns
$t_{su(C16-CS)}$	Setup time, 16 th negative SCLK edge (when D0 is sampled) before \overline{CS} rising edge	10			ns
t_{wH}	SCLK pulse width high	25			ns
t_{wL}	SCLK pulse width low	25			ns
$t_{su(D)}$	Setup time, data ready before SCLK falling edge	10			ns
$t_{h(D)}$	Hold time, data held valid after SCLK falling edge	5			ns

PARAMETER MEASUREMENT INFORMATION

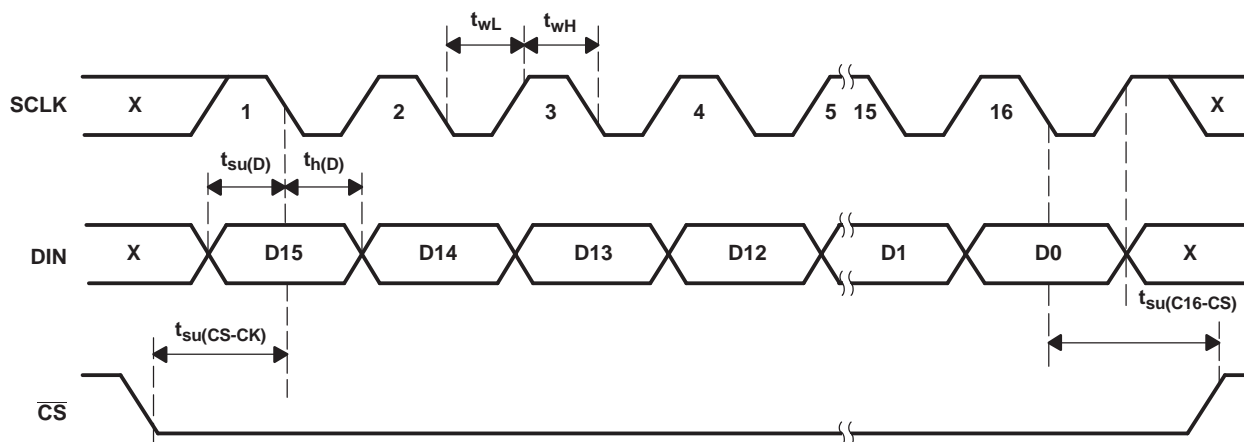

Figure 1. Timing Diagram

TYPICAL CHARACTERISTICS

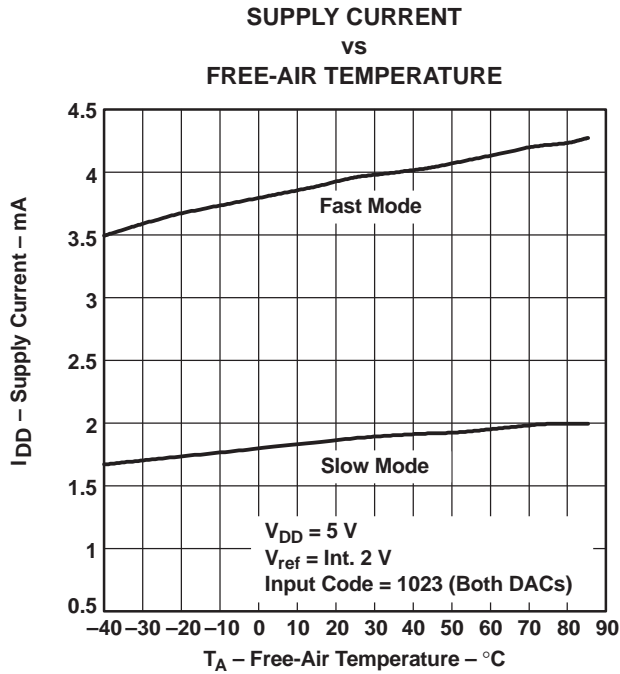

Figure 2.

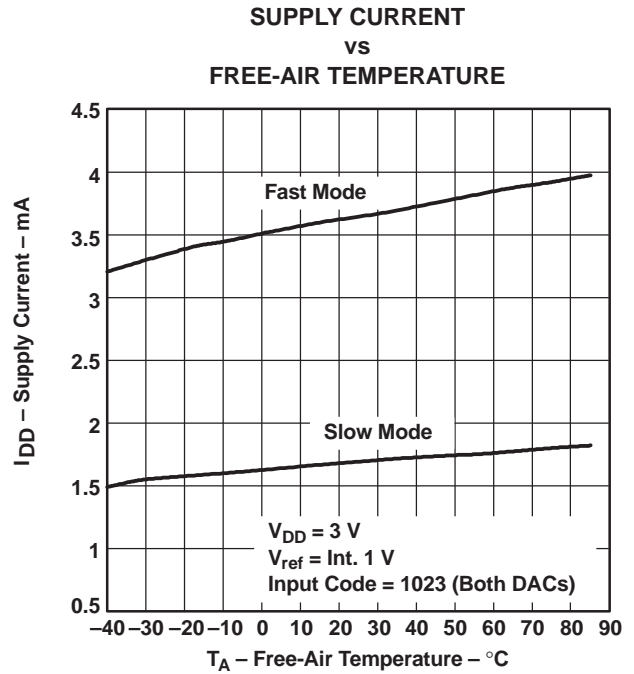

Figure 3.

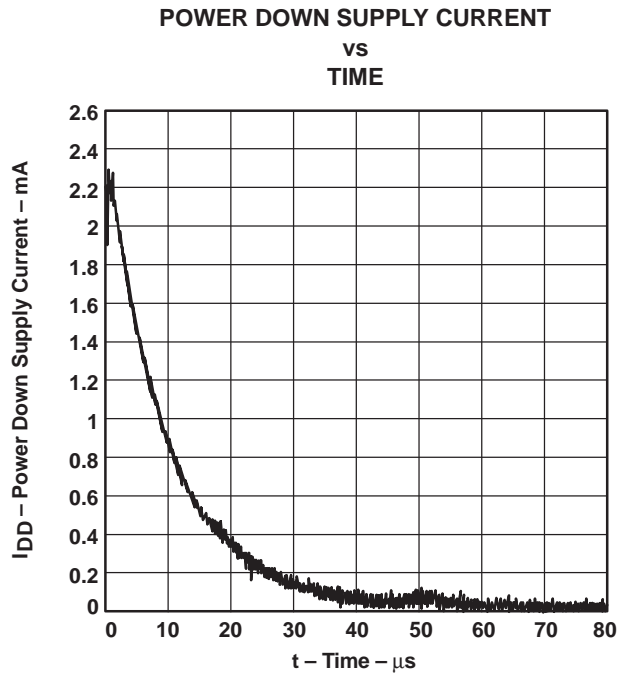

Figure 4.

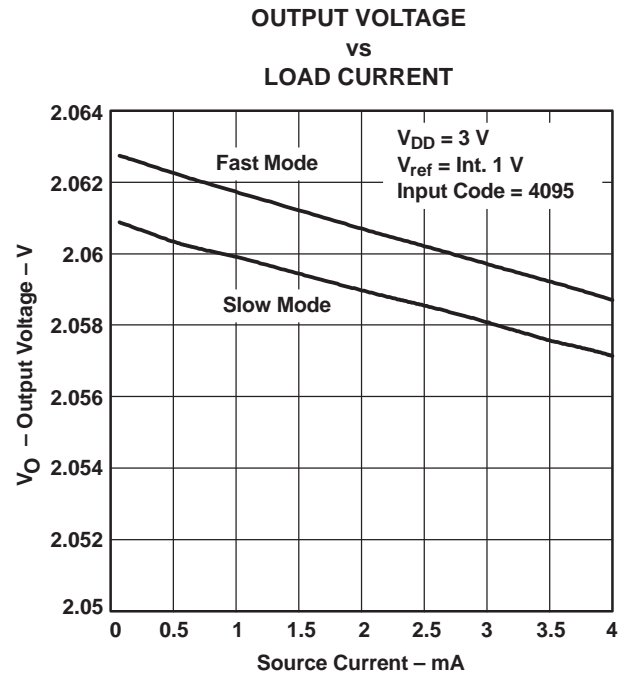
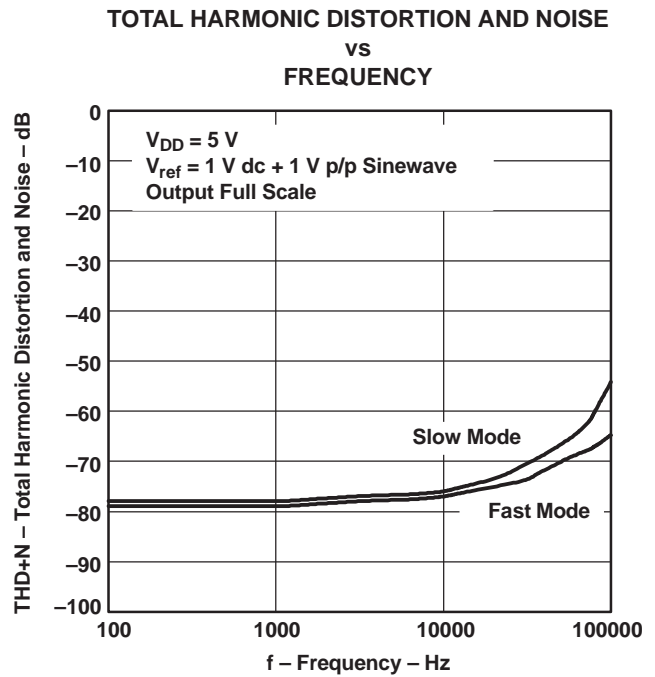
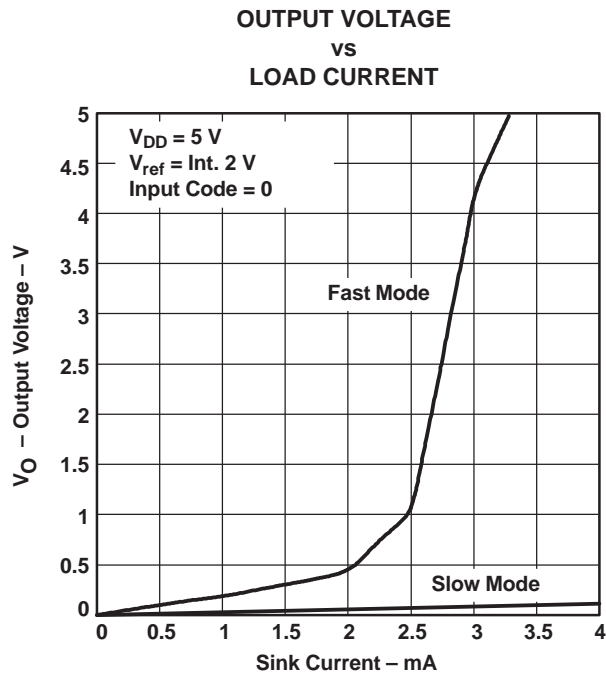
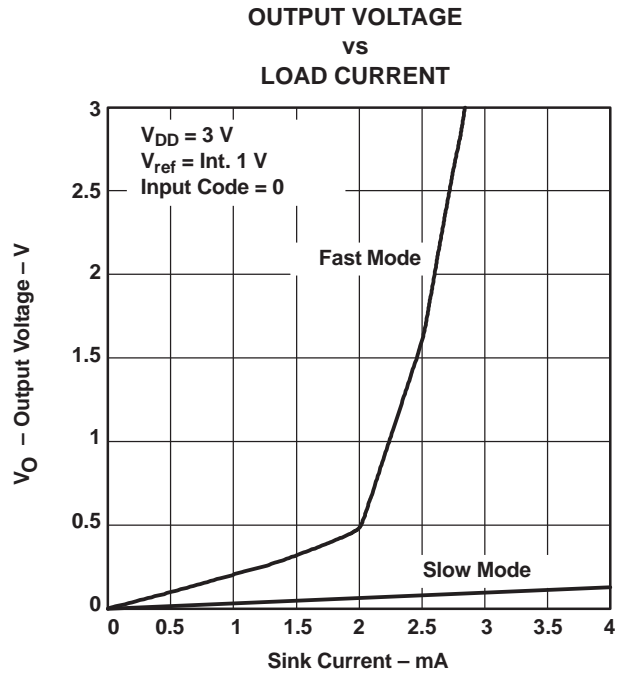
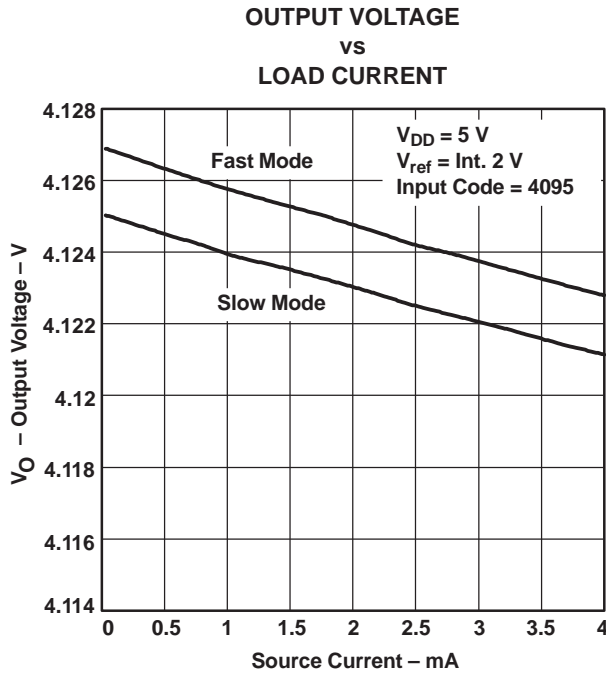

Figure 5.

TYPICAL CHARACTERISTICS (continued)



TYPICAL CHARACTERISTICS (continued)
TOTAL HARMONIC DISTORTION
VS
FREQUENCY

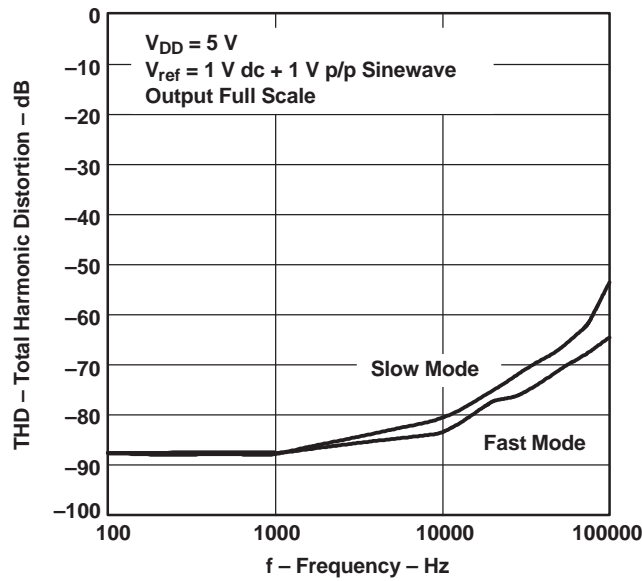

Figure 10.

INTEGRAL NONLINEARITY ERROR

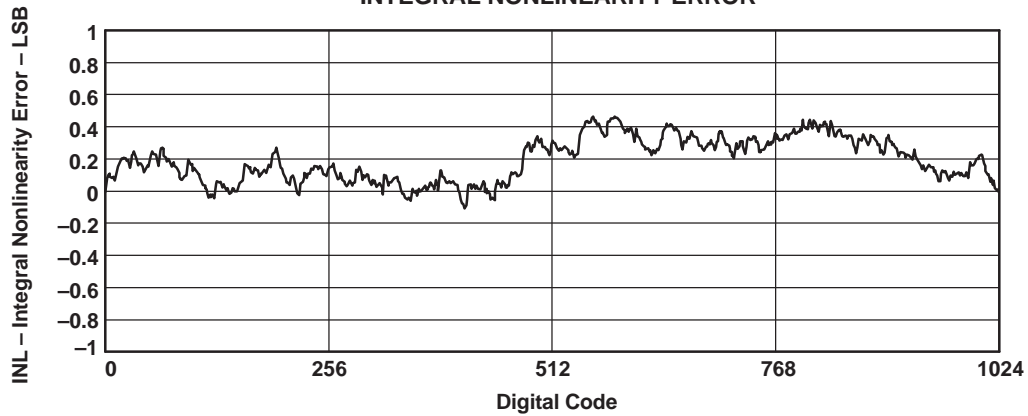

Figure 11.

DIFFERENTIAL NONLINEARITY ERROR

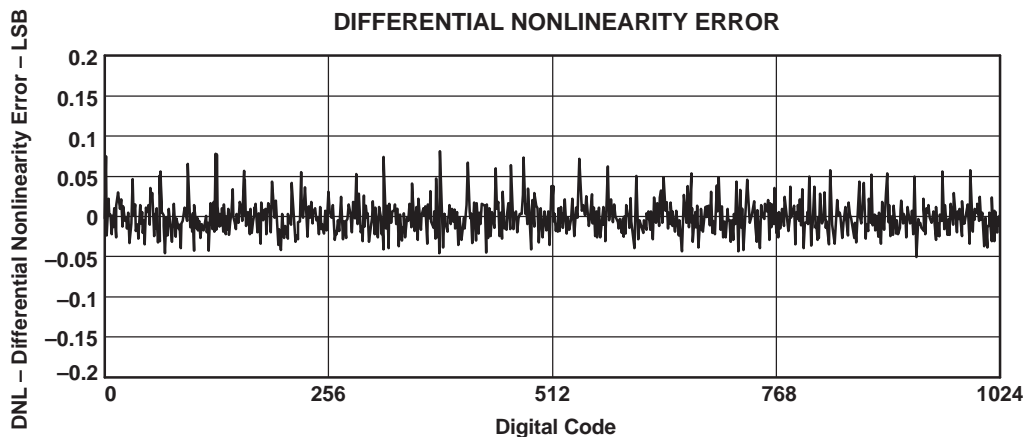

Figure 12.

APPLICATION INFORMATION

GENERAL FUNCTION

The TLV5637 is a dual 10-bit, single supply DAC, based on a resistor string architecture. It consists of a serial interface, a speed and power-down control logic, a programmable internal reference, a resistor string, and a rail-to-rail output buffer.

The output voltage (full scale determined by reference) is given by:

$$2 \text{ REF } \frac{\text{CODE}}{0x1000} \text{ [V]}$$

Where REF is the reference voltage and CODE is the digital input value in the range 0x000 to 0xFFFF. Because it is a 10-bit DAC, only D11 to D2 are used. D0 and D1 are ignored. A power-on reset initially puts the internal latches to a defined state (all bits zero).

SERIAL INTERFACE

A falling edge of $\overline{\text{CS}}$ starts shifting the data bit-per-bit (starting with the MSB) to the internal register on the falling edges of SCLK. After 16 bits have been transferred or $\overline{\text{CS}}$ rises, the content of the shift register is moved to the target latches (DAC A, DAC B, BUFFER, CONTROL), depending on the control bits within the data word.

Figure 13 shows examples of how to connect the TLV5637 to TMS320, SPI, and Microwire.

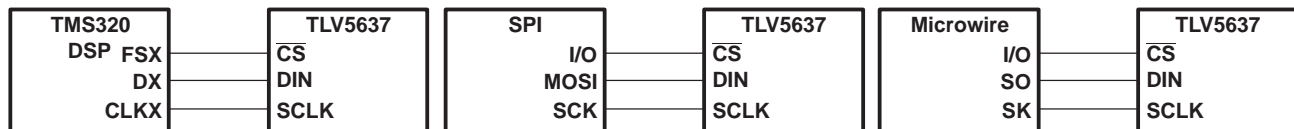

Figure 13. Three-Wire Interface

Notes on SPI and Microwire: Before the controller starts the data transfer, the software has to generate a falling edge on the I/O pin connected to $\overline{\text{CS}}$. If the word width is 8 bits (SPI and Microwire), two write operations must be performed to program the TLV5637. After the write operation(s), the holding registers or the control register are updated automatically on the 16th positive clock edge.

SERIAL CLOCK FREQUENCY AND UPDATE RATE

The maximum serial clock frequency is given by:

$$f_{\text{sclkmax}} = \frac{1}{(t_{\text{whmin}} + t_{\text{wlmin}})} = 20\text{MHz}$$

The maximum update rate is:

$$f_{\text{updatemax}} = \frac{1}{16 (t_{\text{whmin}} + t_{\text{wlmin}})} = 1.25\text{MHz}$$

Note that the maximum update rate is just a theoretical value for the serial interface, as the settling time of the TLV5637 has to be considered as well.

APPLICATION INFORMATION (continued)

DATA FORMAT

The 16-bit data word for the TLV5637 consists of two parts:

- Program bits (D15..D12)
- New data (D11..D0)

D15	D14	D13	D12	D11	D10	D9	D8	D7	D6	D5	D4	D3	D2	D1	D0
R1	SPD	PWR	R0	12 Data bits											

SPD: Speed control bit 1 → fast mode 0 → slow mode

PWR: Power control bit 1 → power down 0 → normal operation

The following table lists the possible combination of the register select bits:

Register Select Bits

R1	R0	REGISTER
0	0	Write data to DAC B and BUFFER
0	1	Write data to BUFFER
1	0	Write data to DAC A and update DAC B with BUFFER content
1	1	Write data to control register

The meaning of the 12 data bits depends on the register. If one of the DAC registers or the BUFFER is selected, then the 12 data bits determine the new DAC value:

Data Bits: DAC A, DAC B and BUFFER

D11	D10	D9	D8	D7	D6	D5	D4	D3	D2	D1	D0
New DAC Value										0	0

If control is selected, then D1, D0 of the 12 data bits are used to program the reference voltage:

Data Bits: CONTROL

D11	D10	D9	D8	D7	D6	D5	D4	D3	D2	D1	D0
X	X	X	X	X	X	X	X	X	X	REF1	REF0

X: don't care

REF1 and REF0 determine the reference source and, if internal reference is selected, the reference voltage.

APPLICATION INFORMATION

REFERENCE BITS

REF1	REF0	REFERENCE
0	0	External
0	1	1.024V
1	0	2.048V
1	1	External

CAUTION:

If external reference voltage is applied to the REF pin, external reference MUST be selected.

EXAMPLES OF OPERATION:

- Set DAC A output, select fast mode, select internal reference at 2.048V:

- Set reference voltage to 2.048V (CONTROL register):

D15	D14	D13	D12	D11	D10	D9	D8	D7	D6	D5	D4	D3	D2	D1	D0
1	1	0	1	0	0	0	0	0	0	0	0	0	0	1	0

- Write new DAC A value and update DAC A output:

D15	D14	D13	D12	D11	D10	D9	D8	D7	D6	D5	D4	D3	D2	D1	D0
1	1	0	0	New DAC A output value										0	0

The DAC A output is updated on the rising clock edge after D0 is sampled.

To output data consecutively using the same DAC configuration, it is not necessary to program the CONTROL register again.

- Set DAC B output, select fast mode, select external reference:

- Select external reference (CONTROL register):

D15	D14	D13	D12	D11	D10	D9	D8	D7	D6	D5	D4	D3	D2	D1	D0
1	1	0	1	0	0	0	0	0	0	0	0	0	0	0	0

- Write new DAC B value to BUFFER and update DAC B output:

D15	D14	D13	D12	D11	D10	D9	D8	D7	D6	D5	D4	D3	D2	D1	D0
0	1	0	0	New BUFFER content and DAC B output value										0	0

The DAC A output is updated on the rising clock edge after D0 is sampled.

To output data consecutively using the same DAC configuration, it is not necessary to program the CONTROL register again.

- Set DAC A value, set DAC B value, update both simultaneously, select slow mode, select internal reference at 1.024V:

- Set reference voltage to 1.024V (CONTROL register):

D15	D14	D13	D12	D11	D10	D9	D8	D7	D6	D5	D4	D3	D2	D1	D0
1	0	0	1	0	0	0	0	0	0	0	0	0	0	0	1

- Write data for DAC B to BUFFER:

D15	D14	D13	D12	D11	D10	D9	D8	D7	D6	D5	D4	D3	D2	D1	D0
0	0	0	1	New DAC B value										0	0

- Write new DAC A value and update DAC A and B simultaneously:

D15	D14	D13	D12	D11	D10	D9	D8	D7	D6	D5	D4	D3	D2	D1	D0
1	0	0	0	New DAC A value										0	0

Both outputs are updated on the rising clock edge after D0 from the DAC A data word is sampled.

- Set power down mode:

D15	D14	D13	D12	D11	D10	D9	D8	D7	D6	D5	D4	D3	D2	D1	D0
X	X	1	X	X	X	X	X	X	X	X	X	X	X	X	X

X = Don't care

LINEARITY, OFFSET, AND GAIN ERROR USING SINGLE ENDED SUPPLIES

When an amplifier is operated from a single supply, the voltage offset can still be either positive or negative. With a positive offset, the output voltage changes on the first code change. With a negative offset, the output voltage may not change with the first code, depending on the magnitude of the offset voltage.

The output amplifier attempts to drive the output to a negative voltage. However, because the most negative supply rail is ground, the output cannot drive below ground and clamps the output at 0V.

The output voltage then remains at zero until the input code value produces a sufficiently positive output voltage to overcome the negative offset voltage, resulting in the transfer function shown in [Figure 14](#).

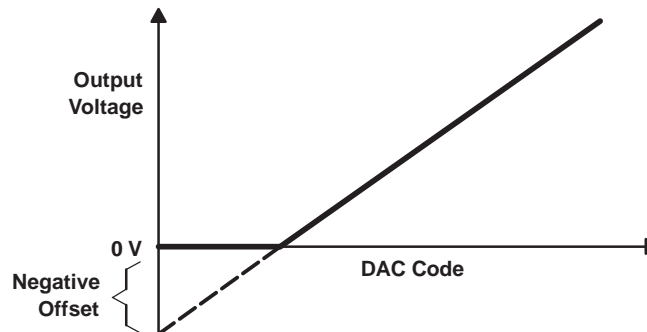

Figure 14. Effect of Negative Offset (Single Supply)

This offset error, not the linearity error, produces this breakpoint. The transfer function would have followed the dotted line if the output buffer could drive below the ground rail.

For a DAC, linearity is measured between zero-input code (all inputs 0) and full-scale code (all inputs 1) after offset and full scale are adjusted out or accounted for in some way. However, single supply operation does not allow for adjustment when the offset is negative due to the breakpoint in the transfer function. So the linearity is measured between full-scale code and the lowest code that produces a positive output voltage.

DEFINITIONS OF SPECIFICATIONS AND TERMINOLOGY

Integral Nonlinearity (INL)

The relative accuracy or integral nonlinearity (INL), sometimes referred to as linearity error, is the maximum deviation of the output from the line between zero and full scale excluding the effects of zero code and full-scale errors.

Differential Nonlinearity (DNL)

The differential nonlinearity (DNL), sometimes referred to as differential error, is the difference between the measured and ideal 1LSB amplitude change of any two adjacent codes. Monotonic means the output voltage changes in the same direction (or remains constant) as a change in the digital input code.

Zero-Scale Error (E_{ZS})

Zero-scale error is defined as the deviation of the output from 0V at a digital input value of 0.

GAIN ERROR (E_G)

Gain error is the error in slope of the DAC transfer function.

SIGNAL-TO-NOISE RATIO + DISTORTION (S/N+D)

S/N+D is the ratio of the rms value of the measured input signal to the rms sum of all other spectral components below the Nyquist frequency, including harmonics but excluding dc. The value for S/N+D is expressed in decibels.

SPURIOUS FREE DYNAMIC RANGE (SFDR)

Spurious free dynamic range is the difference between the rms value of the output signal and the rms value of the spurious signal within a specified bandwidth. The value for SFDR is expressed in decibels.

Revision History

NOTE: Page numbers for previous revisions may differ from page numbers in the current version.

Changes from B Revision (January 2004) to C Revision	Page
• Changed —moved package option table from front page.....	3

PACKAGING INFORMATION

Orderable Device	Status ⁽¹⁾	Package Type	Package Drawing	Pins	Package Qty	Eco Plan ⁽²⁾	Lead/ Ball Finish	MSL Peak Temp ⁽³⁾	Samples (Requires Login)
TLV5637CD	ACTIVE	SOIC	D	8	75	Green (RoHS & no Sb/Br)	CU NIPDAU	Level-1-260C-UNLIM	
TLV5637CDG4	ACTIVE	SOIC	D	8	75	Green (RoHS & no Sb/Br)	CU NIPDAU	Level-1-260C-UNLIM	
TLV5637CDRG4	ACTIVE	SOIC	D	8	2500	Green (RoHS & no Sb/Br)	CU NIPDAU	Level-1-260C-UNLIM	
TLV5637ID	ACTIVE	SOIC	D	8	75	Green (RoHS & no Sb/Br)	CU NIPDAU	Level-1-260C-UNLIM	
TLV5637IDG4	ACTIVE	SOIC	D	8	75	Green (RoHS & no Sb/Br)	CU NIPDAU	Level-1-260C-UNLIM	
TLV5637IDR	ACTIVE	SOIC	D	8	2500	Green (RoHS & no Sb/Br)	CU NIPDAU	Level-1-260C-UNLIM	
TLV5637IDRG4	ACTIVE	SOIC	D	8	2500	Green (RoHS & no Sb/Br)	CU NIPDAU	Level-1-260C-UNLIM	

⁽¹⁾ The marketing status values are defined as follows:

ACTIVE: Product device recommended for new designs.

LIFEBUY: TI has announced that the device will be discontinued, and a lifetime-buy period is in effect.

NRND: Not recommended for new designs. Device is in production to support existing customers, but TI does not recommend using this part in a new design.

PREVIEW: Device has been announced but is not in production. Samples may or may not be available.

OBSOLETE: TI has discontinued the production of the device.

⁽²⁾ Eco Plan - The planned eco-friendly classification: Pb-Free (RoHS), Pb-Free (RoHS Exempt), or Green (RoHS & no Sb/Br) - please check <http://www.ti.com/productcontent> for the latest availability information and additional product content details.

TBD: The Pb-Free/Green conversion plan has not been defined.

Pb-Free (RoHS): TI's terms "Lead-Free" or "Pb-Free" mean semiconductor products that are compatible with the current RoHS requirements for all 6 substances, including the requirement that lead not exceed 0.1% by weight in homogeneous materials. Where designed to be soldered at high temperatures, TI Pb-Free products are suitable for use in specified lead-free processes.

Pb-Free (RoHS Exempt): This component has a RoHS exemption for either 1) lead-based flip-chip solder bumps used between the die and package, or 2) lead-based die adhesive used between the die and leadframe. The component is otherwise considered Pb-Free (RoHS compatible) as defined above.

Green (RoHS & no Sb/Br): TI defines "Green" to mean Pb-Free (RoHS compatible), and free of Bromine (Br) and Antimony (Sb) based flame retardants (Br or Sb do not exceed 0.1% by weight in homogeneous material)

⁽³⁾ MSL, Peak Temp. -- The Moisture Sensitivity Level rating according to the JEDEC industry standard classifications, and peak solder temperature.

Important Information and Disclaimer: The information provided on this page represents TI's knowledge and belief as of the date that it is provided. TI bases its knowledge and belief on information provided by third parties, and makes no representation or warranty as to the accuracy of such information. Efforts are underway to better integrate information from third parties. TI has taken and

continues to take reasonable steps to provide representative and accurate information but may not have conducted destructive testing or chemical analysis on incoming materials and chemicals. TI and TI suppliers consider certain information to be proprietary, and thus CAS numbers and other limited information may not be available for release.

In no event shall TI's liability arising out of such information exceed the total purchase price of the TI part(s) at issue in this document sold by TI to Customer on an annual basis.

TAPE AND REEL INFORMATION
REEL DIMENSIONS

TAPE DIMENSIONS

A0	Dimension designed to accommodate the component width
B0	Dimension designed to accommodate the component length
K0	Dimension designed to accommodate the component thickness
W	Overall width of the carrier tape
P1	Pitch between successive cavity centers

TAPE AND REEL INFORMATION

*All dimensions are nominal

Device	Package Type	Package Drawing	Pins	SPQ	Reel Diameter (mm)	Reel Width W1 (mm)	A0 (mm)	B0 (mm)	K0 (mm)	P1 (mm)	W (mm)	Pin1 Quadrant
TLV5637IDR	SOIC	D	8	2500	330.0	12.4	6.4	5.2	2.1	8.0	12.0	Q1

TAPE AND REEL BOX DIMENSIONS

*All dimensions are nominal

Device	Package Type	Package Drawing	Pins	SPQ	Length (mm)	Width (mm)	Height (mm)
TLV5637IDR	SOIC	D	8	2500	367.0	367.0	35.0

D (R-PDSO-G8)

PLASTIC SMALL OUTLINE



- NOTES:
- A. All linear dimensions are in inches (millimeters).
 - B. This drawing is subject to change without notice.
 - Body length does not include mold flash, protrusions, or gate burrs. Mold flash, protrusions, or gate burrs shall not exceed 0.006 (0,15) each side.
 - Body width does not include interlead flash. Interlead flash shall not exceed 0.017 (0,43) each side.
 - E. Reference JEDEC MS-012 variation AA.

IMPORTANT NOTICE

Texas Instruments Incorporated and its subsidiaries (TI) reserve the right to make corrections, enhancements, improvements and other changes to its semiconductor products and services per JESD46C and to discontinue any product or service per JESD48B. Buyers should obtain the latest relevant information before placing orders and should verify that such information is current and complete. All semiconductor products (also referred to herein as "components") are sold subject to TI's terms and conditions of sale supplied at the time of order acknowledgment.

TI warrants performance of its components to the specifications applicable at the time of sale, in accordance with the warranty in TI's terms and conditions of sale of semiconductor products. Testing and other quality control techniques are used to the extent TI deems necessary to support this warranty. Except where mandated by applicable law, testing of all parameters of each component is not necessarily performed.

TI assumes no liability for applications assistance or the design of Buyers' products. Buyers are responsible for their products and applications using TI components. To minimize the risks associated with Buyers' products and applications, Buyers should provide adequate design and operating safeguards.

TI does not warrant or represent that any license, either express or implied, is granted under any patent right, copyright, mask work right, or other intellectual property right relating to any combination, machine, or process in which TI components or services are used. Information published by TI regarding third-party products or services does not constitute a license to use such products or services or a warranty or endorsement thereof. Use of such information may require a license from a third party under the patents or other intellectual property of the third party, or a license from TI under the patents or other intellectual property of TI.

Reproduction of significant portions of TI information in TI data books or data sheets is permissible only if reproduction is without alteration and is accompanied by all associated warranties, conditions, limitations, and notices. TI is not responsible or liable for such altered documentation. Information of third parties may be subject to additional restrictions.

Resale of TI components or services with statements different from or beyond the parameters stated by TI for that component or service voids all express and any implied warranties for the associated TI component or service and is an unfair and deceptive business practice. TI is not responsible or liable for any such statements.

Buyer acknowledges and agrees that it is solely responsible for compliance with all legal, regulatory and safety-related requirements concerning its products, and any use of TI components in its applications, notwithstanding any applications-related information or support that may be provided by TI. Buyer represents and agrees that it has all the necessary expertise to create and implement safeguards which anticipate dangerous consequences of failures, monitor failures and their consequences, lessen the likelihood of failures that might cause harm and take appropriate remedial actions. Buyer will fully indemnify TI and its representatives against any damages arising out of the use of any TI components in safety-critical applications.

In some cases, TI components may be promoted specifically to facilitate safety-related applications. With such components, TI's goal is to help enable customers to design and create their own end-product solutions that meet applicable functional safety standards and requirements. Nonetheless, such components are subject to these terms.

No TI components are authorized for use in FDA Class III (or similar life-critical medical equipment) unless authorized officers of the parties have executed a special agreement specifically governing such use.

Only those TI components which TI has specifically designated as military grade or "enhanced plastic" are designed and intended for use in military/aerospace applications or environments. Buyer acknowledges and agrees that any military or aerospace use of TI components which have **not** been so designated is solely at the Buyer's risk, and that Buyer is solely responsible for compliance with all legal and regulatory requirements in connection with such use.

TI has specifically designated certain components which meet ISO/TS16949 requirements, mainly for automotive use. Components which have not been so designated are neither designed nor intended for automotive use; and TI will not be responsible for any failure of such components to meet such requirements.

Products

Audio	www.ti.com/audio
Amplifiers	amplifier.ti.com
Data Converters	dataconverter.ti.com
DLP® Products	www.dlp.com
DSP	dsp.ti.com
Clocks and Timers	www.ti.com/clocks
Interface	interface.ti.com
Logic	logic.ti.com
Power Mgmt	power.ti.com
Microcontrollers	microcontroller.ti.com
RFID	www.ti-rfid.com
OMAP Mobile Processors	www.ti.com/omap
Wireless Connectivity	www.ti.com/wirelessconnectivity

Applications

Automotive and Transportation	www.ti.com/automotive
Communications and Telecom	www.ti.com/communications
Computers and Peripherals	www.ti.com/computers
Consumer Electronics	www.ti.com/consumer-apps
Energy and Lighting	www.ti.com/energy
Industrial	www.ti.com/industrial
Medical	www.ti.com/medical
Security	www.ti.com/security
Space, Avionics and Defense	www.ti.com/space-avionics-defense
Video and Imaging	www.ti.com/video

TI E2E Community e2e.ti.com