

PROGRAMMABLE COMMUNICATION INTERFACE

TMP8251AP

1. GENERAL DESCRIPTION

The TMP8251AP is the industry standard Universal Synchronous/Asynchronous Receiver/Transmitter (USART) that is fabricated using N-channel silicon gate MOS technology.

The TMP8251A is mainly used for 8-bit microcomputer extension systems, which require serial data communications.

The TMP8251AP is packaged in the 28pin standard Dual Inline package.

FEATURES

- Synchronous:
 - 5-8 Bit Characters
 - Internal or External Character Synchronization
 - Single or Double Character Synchronization (Internal)
 - Automatic Sync Insertion
- Asynchronous:
 - 5-8 Bit Characters
 - Clock Rate - 1, 16 or 64 Times Transfer Rate
 - Break Character Generation
 - 1, 1½, or 2 Stop Bits
 - False Start Bit Detection
 - Automatic Break Detect and Handling
- Transfer Rate DC to 64K bps (Synchronous)
 - DC to 19.6K bps (Asynchronous)
- Full-Duplex, Double-Buffered, Transmitter and Receiver
- Error Detection Parity, Overrun and Framing
- Single +5V Supply
- Compatible with Intel's 8251A/S2657

2. PIN CONNECTIONS (TOP VIEW)

D ₂	1	28	D ₇
D ₃	2	27	D ₀
RxD	3	26	VCC
GND	4	25	RxC
D ₄	5	24	DTR
D ₅	6	23	RTS
D ₆	7	22	DSR
D ₇	8	21	RESET
TxC	9	20	CLK
WR	10	19	TxD
CS	11	18	TxEMPTY
C/D	12	17	CTS
RD	13	16	SYNDET:BD
RxRDY	14	15	TxRDY

3. BLOCK DIAGRAM

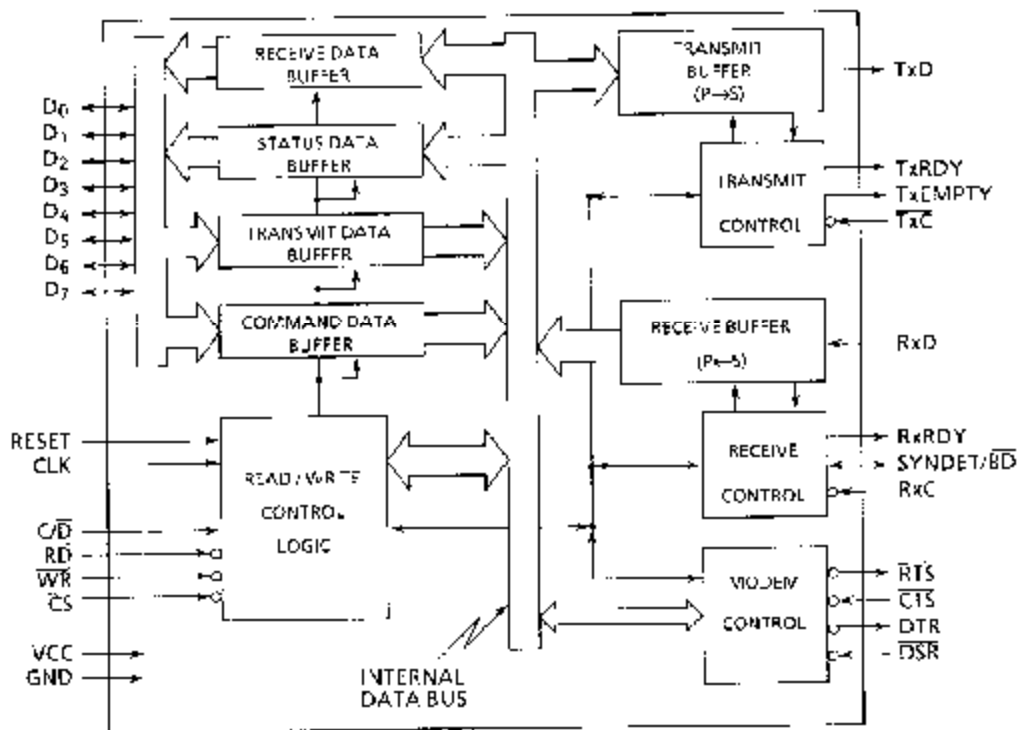

4. PIN NAMES AND PIN DESCRIPTIONS

4.1 INTERFACE SIGNALS TO MPU (MAIN SYSTEM)

- $D_0 \sim D_7$ (Input/Output)

This 8-state bidirectional, 8-bit buffer is used to interface the 8251A to the system Data Bus. Data is transmitted or received through the buffer upon execution of Input or Output Instructions of the MPU. Control Words, Command Words and Status Information are also transferred through the Data Bus Buffer.

- \overline{WR} (Input)

A "low" level signal on this input informs the 8251A that the MPU is Writing Data or Control Words to the 8251A.

- \overline{RD} (Input)

A "low" level signal on this input informs the 8251A that the MPU is Reading Data or Status Information from the 8251A.

- \overline{CS} (Input)

A "low" level signal on this input selects the 8251A. No reading or writing operation will occur unless the device is selected. When \overline{CS} is "high" the Data Bus is in the floating state and \overline{RD} and \overline{WR} have no effect on the chips.

- C/D (Input)

This input signal, in conjunction with the \overline{WR} and \overline{RD} inputs, informs the 8251A that the word on the Data Bus is either a Data Character, Control Word or Status Information. A "high" level signal means Control or Status, a "low" level signal means Data.

C/D	\overline{RD}	\overline{WR}	\overline{CS}	
0	0	1	0	8251A Retrieve DATA Buffer → Data Bus
0	1	0	0	8251A Transmit DATA Buffer ← Data Bus
1	0	1	0	8251A Status DATA Buffer → Data Bus
1	1	0	0	8251A Command DATA Buffer ← Data Bus
x	1	1	0	DATA Bus is in floating state.
x	x	x	1	←

- CLK (Input)

The CLK input is used to generate internal device timing. No external input or output is referenced to CLK, but the frequency of CLK must be greater than 30 times the Receiver or Transmitter Data Bit Rates (RxC or TxC) in Synchronous Operation, and greater than 4.5 times the Receiver Data Bit Rate (RxC) in Asynchronous Operation.

- RESET (Input)

A "high" level signal on this input forces the 8251A into an "Idle" mode. The device will remain at "Idle" until a new set of Control Words is written into the 8251A to program its functional definition. Minimum RESET pulse width is 6 tcy.

4.2 MODEM CONTROL SIGNALS

- \overline{DSR} (Input)

The \overline{DSR} input signal is a general purpose, 1-bit inverting input port. Its condition can be tested by the MPU using a Status Read Operation. The \overline{DSR} input is normally used to test MODEM conditions such as Data Set Ready signal.

- \overline{DTR} (Output)

The \overline{DTR} output signal is a general purpose, 1-bit inverting output port. It can be set "low" by programming the appropriate bit in the Command Instruction Word. The \overline{DTR} output signal is normally used for MODEM control such as Data Terminal Ready or Rate Select signal.

- RTS (Output)

The RTS output signal is a general purpose, 1-bit inverting output port. It can be set "low" by programming the appropriate bit in the Command Instruction Word. The RTS output signal is normally used for MODEM control such as Request to Send signal.

- \overline{CTS} (Input)

A "low" level signal on this input enables the 8251A to transmit serial data, if the Tx Enable Bit in the Command Byte is set to a "one" (TxEN=1). If either a Tx Enable off (TxEN=0) or CTS off (\overline{CTS} =1) condition occurs while the Tx is in operation, the Tx will transmit all the data in the USART, written prior to Tx Disable Command before shutting down.

4.3 TRANSMIT CONTROL SIGNALS

- $\overline{\text{TxC}}$ (Input)

The Transmitter Clock Controls the rate at which the character is to be transmitted. In the Synchronous Transmission Mode, the transfer rate (1x) is equal to the $\overline{\text{TxC}}$ frequency. In Asynchronous Transmission Mode, the transfer rate is a fraction of the actual $\overline{\text{TxC}}$ frequency. A portion of the Mode Instruction selects this factor; it can be 1, 1/16 or 1/64 the $\overline{\text{TxC}}$.

For Example:

If transfer rate equals 110 bps,

$\overline{\text{TxC}} = 110 \text{ Hz (1x)}$

$\overline{\text{TxC}} = 1.76 \text{ KHz (16x)}$

$\overline{\text{TxC}} = 7.04 \text{ KHz (64x)}$

The falling edge of $\overline{\text{TxC}}$ shifts the serial data out of the 8251A.

- TxD (Output)

This line is used to transmit the serial data. Serial output data on TxD is changed from parallel data to serial data in accordance with the format specified by the Control Words.

TxD line will be held in the marking state ('1' level) immediately on one of the following:

- Master Reset
- TxD Disable ($\text{TxE} = 0$)
- CTS signal is high ($\text{CTS} = 1$)
- TxE signal is high ($\text{TxE} = 1$)

- TxDY (Output)

This output informs the MPU that the transmitter is ready to accept a Data Character. The TxDY output pin can be used as an interrupt to the system, since it is masked by TxD Disable ($\text{TxE} = 0$), or, for polled Operation, the MPU can check TxDY using a Status Read Operation. TxDY is automatically reset by the trailing edge of $\overline{\text{WE}}$ when a Data Character is loaded from the MPU. The TxDY pin output status (TxDY (pin)) is different from the TxDY status bit status (TxDY (status bit)) as follows.

$\text{TxDY (status bit)} = (\text{Transmit Data Buffer Empty})$

$\text{TxDY (pin)} = (\text{Transmit Data Buffer Empty}) \cdot (\text{CTS} = 0) \cdot (\text{TxE} = 1)$

- TxE (Output)

The TxE output will go "high" when the 8251A has no characters to send. It resets upon receiving a character from the MPU if the transmitter is enabled.

In Synchronous Mode, a "high" level signal on this output indicates that a Character has not been loaded and the SYNC Character or Characters are about to be or are being transmitted automatically as "fillers". Tx EMPTY does not go "low" when the SYNC characters are being shifted out.

4.4 RECEIVE CONTROL SIGNALS

- $\overline{\text{RxC}}$ (Input)

The Receiver Clock controls the rate at which the character is to be received. In Synchronous Mode, the Transfer Rate (1x) is equal to the actual frequency of $\overline{\text{RxC}}$. In Asynchronous Mode, the Transfer Rate is a fraction of the actual $\overline{\text{RxC}}$ frequency. A portion of the Mode Instruction selects this factor; 1, 1/16 or 1/64 the $\overline{\text{RxC}}$.

For Example:

if Transfer Rate equals 2400 bps,

$$\overline{\text{RxC}} = 2.4 \text{ KHz (1x)}$$

$$\overline{\text{RxC}} = 38.4 \text{ KHz (16x)}$$

$$\overline{\text{RxC}} = 153.6 \text{ KHz (64x)}$$

Data is sampled into the 8251A on the rising edge of $\overline{\text{RxC}}$.

- Rx D (Input)

This line is used to receive the serial data. Serial input data on this line is changed to parallel data in accordance with the format specified by the Control Words, and then transferred to the Receive Data Buffer.

- RxRDY (Output)

This output indicates that the 8251A contains a Data Character that is ready to be input to the MPU. RxRDY can be connected to the interrupt structure of the MPU, or, for Polled Operation, the MPU can check the condition of RxRDY using a Status Ready Operation.

Rx Enable off both masks and holds RxRDY in the Reset Condition.

- SYNDET/BD (Input/Output)

This pin is used for SYNDET in Synchronous Mode and may be used as either input or output, programmable through the Control Word. It is reset to output mode "low" upon RESET. When used as an Output (Internal Sync Mode), the SYNDET pin will go "high" to indicate that the 8251A is programmed to use SYNC Character in the Receive Mode. If the 8251A is programmed to use Double Sync Characters then SYNDET will go "high" in the middle of the last bit of the second SYNC Character. SYNDET is automatically reset upon a Status Read Operation. When used as an Input (External Sync Mode), a positive going signal will cause the 8251A to start assembling Data Characters on the rising edge of the next $\overline{\text{RxC}}$.

In Asynchronous Mode this pin is used for BD. This output will go "high" whenever the receiver remains "low" through two consecutive Stop Bit Sequences (including the Start Bits, Data Bits, and Parity Bits). Break Detect may also be read as a Status Bit. It is reset only upon a Master Chip Reset or Rx Data returning to a "one" state. But, if the Rx data returns to a "one" State during the last bit of the next character after the Break, Break detect does not always reset.

4.5 POWER SUPPLY

- VCC (Power)
+5 Volt supply
- GND (Power)
0 Volt supply

5. ELECTRICAL CHARACTERISTICS

5.1 MAXIMUM RATINGS

SYMBOL	ITEM	RATING
V _{CC}	Power Supply Voltage (with respect to GND)	-0.5V to 7.0V
V _{IN}	Input Voltage (with respect to GND)	-0.5V to 7.0V
V _{OUT}	Output Voltage (with respect to GND)	-0.5V to 7.0V
P _D	Power Dissipation (T _a = 70°C)	1W
T _{solder}	Soldering Temperature (10 sec)	260°C
T _{stg.}	Storage Temperature	-55°C to 150°C
T _{opr.}	Operating Temperature	0°C to 70°C

5.2 D.C. CHARACTERISTICS

T_{opr} = 0°C to 70°C, V_{CC} = 5V ± 5%, GND = 0V, Unless otherwise noted.

SYMBOL	PARAMETER	TEST CONDITIONS	MIN.	TYP.	MAX.	UNIT
V _{IL}	Input Low Voltage		-0.5	-	0.8	V
V _{IH}	Input High Voltage		2.2	-	V _{CC}	V
V _{OL}	Output Low Voltage	I _{OL} = 2.2mA	-	-	0.45	V
V _{OH}	Output High Voltage	I _{OH} = -400µA	2.4	-	-	V
I _{OFL}	Output Leak Current	0.45V ≤ V _{OUT} ≤ V _{CC}	-	-	±10	µA
I _{IL}	Input Leak Current	0.45V ≤ V _{IN} ≤ V _{CC}	-	-	±10	µA
I _{CC}	Power Supply Current	All Outputs = "High"	-	-	100	mA

5.3 A.C. CHARACTERISTICS

T_{opr} = 0°C to 70°C, V_{CC} = 5V ± 5%, GND = 0V, Unless otherwise noted.

5.3.1 Bus Read Cycle Timing (Note 1)

SYMBOL	PARAMETER	TEST CONDITIONS	MIN.	TYP.	MAX.	UNIT
t _{AR}	\overline{CS} , C/ \overline{D} Set-up Time for \overline{RD}		50	-	-	ns
t _{RA}	\overline{CS} , C/ \overline{D} Hold Time for \overline{RD}		50	-	-	ns
t _{RR}	\overline{RD} Pulse Width		250	-	-	ns
t _{RD}	Data Delay Time for \overline{RD} (Note 2)	C _L = 150pF (Note 3)	-	-	250	ns
t _{DF}	\overline{CS} , C/ \overline{D} Set-up Time for \overline{RD}		10	-	100	ns

5.3.2 Bus Write Cycle Timing (Note 1)

SYMBOL	PARAMETER	TEST CONDITIONS	MIN.	TYP.	MAX.	UNIT
t_{AW}	\overline{CS} , C/\overline{D} Set-up Time for \overline{WR}		50	–	–	ns
t_{WA}	\overline{CS} , C/\overline{D} Hold Time for \overline{WR}		50	–	–	ns
t_{WW}	\overline{WR} Pulse Width		250	–	–	ns
t_{DW}	Data Set Up Time for \overline{WR}		150	–	–	ns
t_{WD}	Data Hold Time for \overline{WR}		50	–	–	ns
t_{RV}	Recovery Time between \overline{WRITFS}	Note 4)	6	–	–	t_{cyc}

5.3.3 Other Timing

SYMBOL	PARAMETER	MIN.	TYP.	MAX.	UNIT	
t_{cyc}	Clock Period (Note 5), 6)	320	-	1350	ns	
t_H	Clock High Level Width	140	-	$t_{cyc} - 90$	ns	
t_L	Clock Low Level Width	90	-	-	ns	
$t_{R, F}$	Clock Rise and Fall Time	-	-	20	ns	
t_{Dtx}	TxD Delay Time from Falling Edge of Tx \bar{C}	-	-	1	μ s	
f_{Tx}	Transmitter Input Clock Frequency	1x, 64x Baud Rate	DC	-	64	kHz
		16x Baud Rate	DC	-	310	
		64x Baud Rate	DC	-	615	
t_{TPH}	Transmitter Input Clock High Level Width	1x Baud Rate	12	-	-	t_{cyc}
		16, 64x Baud Rate	1	-	-	
t_{TPL}	Transmitter Input Clock Low Level Width	1x Baud Rate	15	-	-	t_{cyc}
		64x Baud Rate	3	-	-	
f_{Rx}	Transmitter Input Clock Frequency	1x Baud Rate	DC	-	64	kHz
		16, 64x Baud Rate	DC	-	310	
		64x Baud Rate	DC	-	615	
t_{RPH}	Transmitter Input Clock High Level Width	1x Baud Rate	12	-	-	t_{cyc}
		64x Baud Rate	1	-	-	
t_{RPL}	Transmitter Input Clock Low Level Width	1x Baud Rate	15	-	-	t_{cyc}
		64x Baud Rate	3	-	-	
t_{TXRDY}	TxRDY Pin Delay Time from Center of Last Bit	-	-	8	t_{cyc}	Note 7
$t_{RXRDY CLEAR}$	TxRDY Clear Delay Time from Trailing Edge of \overline{WR}	-	-	6	t_{cyc}	Note 7
t_{RXRDY}	RxRDY Pin Delay Time from Center of Last Bit	-	-	24	t_{cyc}	Note 7
$t_{RXRDY CLEAR}$	RxRDY Clear Delay Time from Leading Edge of \overline{RD}	-	-	6	t_{cyc}	Note 7
t_{IS}	Internal SYNDET Delay Time from Rising Edge of \overline{RxC}	-	-	24	t_{cyc}	Note 7
t_{ES}	External SYNDET Set-Up Time from Falling Edge of \overline{RxC}	6	-	-	t_{cyc}	Note 7
$t_{TXEMPTY}$	TxEMPTY Delay Time from Center of Last Bit	20	-	-	t_{cyc}	Note 7
t_{WC}	Control Delay Time from Rising Edge of \overline{WR} (TxEN, DTR, RTS)	8	-	-	t_{cyc}	Note 7
t_{CR}	\overline{DSR} , CTS Set-Up Time for \overline{RD}	20	-	-	t_{cyc}	Note 7

Note:

- 1) AC Test Conditions: Output measuring Point $V_{OH}=2.0V$, $V_{OL}=0.8V$
Input supply level $V_{IH}=2.4V$, $V_{IL}=0.45V$
- 2) Assumes that Address is valid before the falling edge of \overline{RD} .
- 3) C_L means load capacitance.
- 4) This recovery time is defined only for Mode Initialization.
Write Data is allowed only when $TxRDY=1$. Recovery Time between Writes for Asynchronous Mode is 8 tcy and for Synchronous Mode is 16 tcy.
- 5) The TxC and RxC frequencies have the following limitations with respect to CLK:
For 1x Transfer Rate, f_{Tx} or $f_{Rx} \leq 1/(30tcy)$
For 16x and 64x Transfer Rate, f_{Tx} or $f_{Rx} \leq 1/(4.5tcy)$
- 6) Minimum Reset Pulse Width is 6 tcy. System Clock must be running during Reset.
- 7) Status up data can have a maximum delay of 28 clock periods from the event affecting the status.

6. TIMING WAVEFORMS

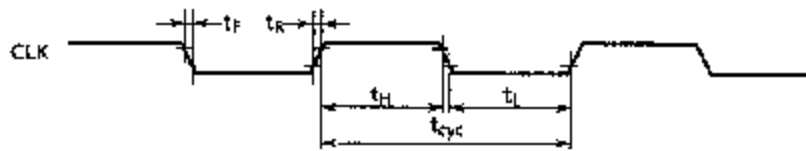

Figure 6.1 System Clock

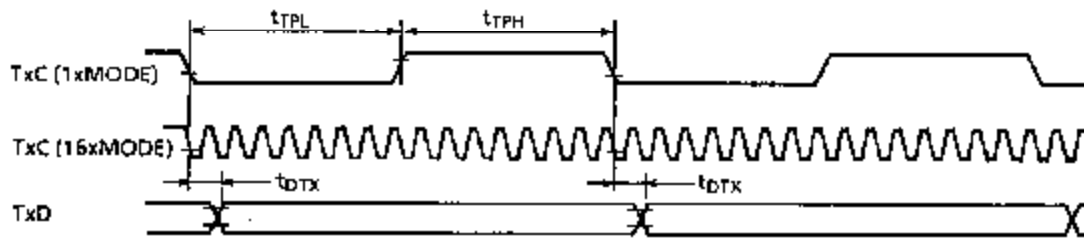

Figure 6.2 Transmitter Clock and Data

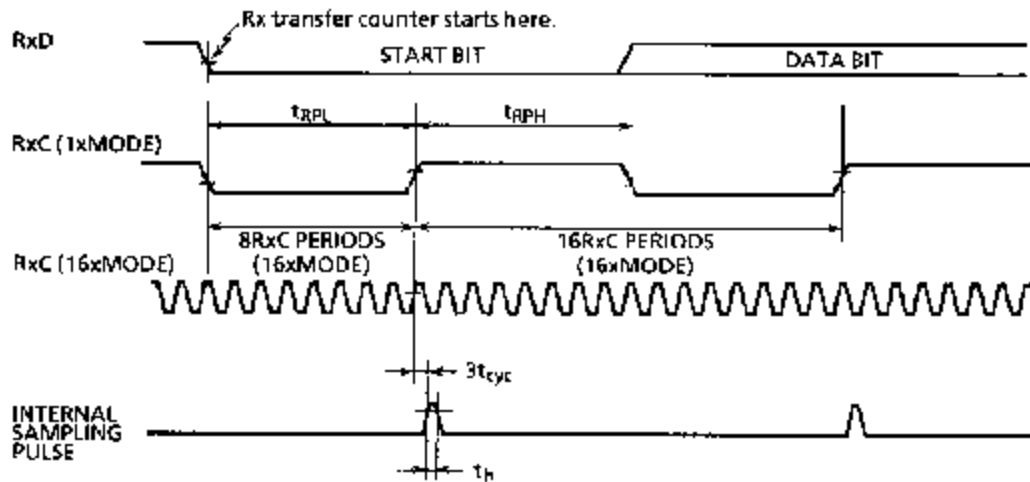

Figure 6.3 Receiver Clock and Data

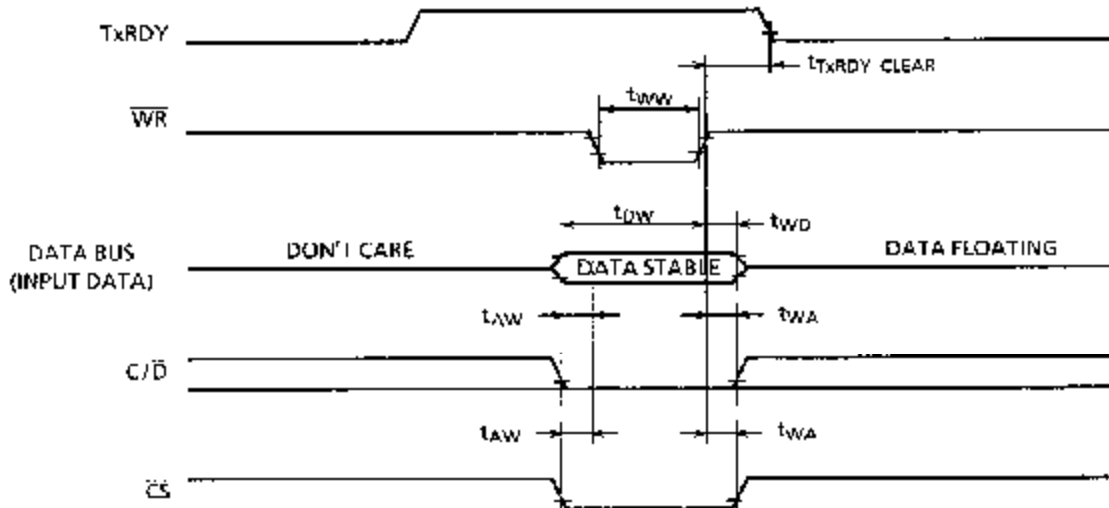

Figure 6.4 Write Data Cycle (MPU→8251A)

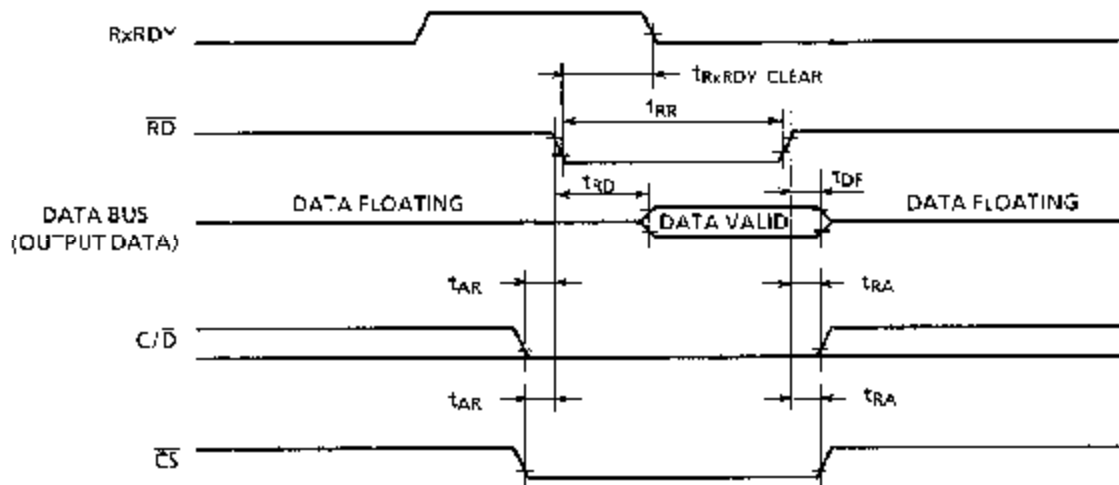

Figure 6.5 Read Data Cycle (8251A→MPU)

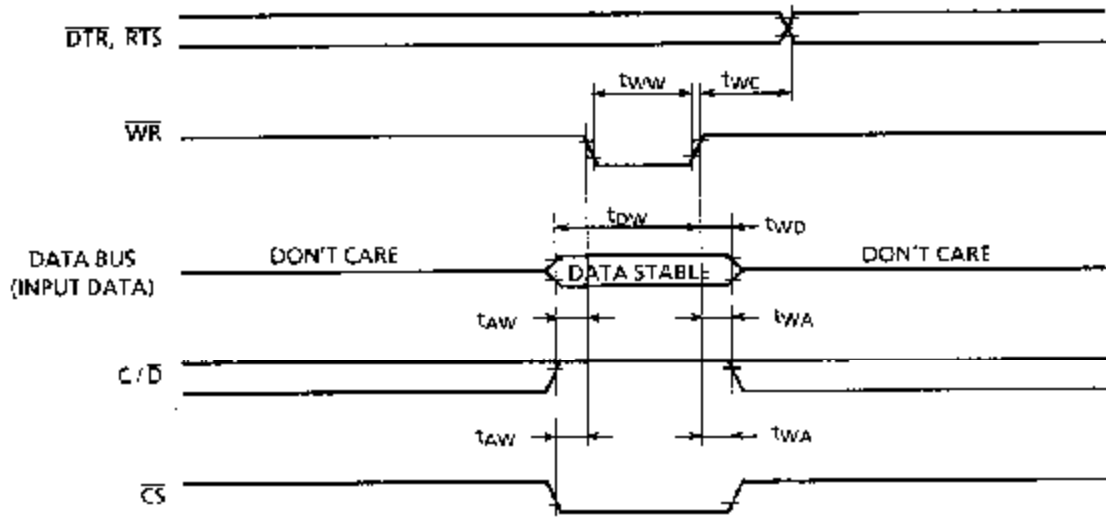

Figure 6.6 Write Control or Output Port Cycle (MPU→82251A)

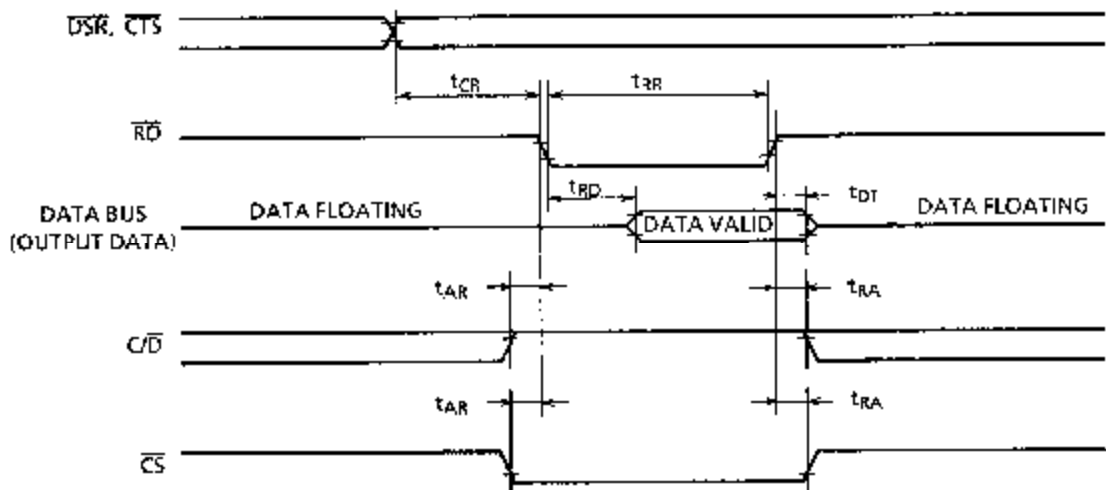
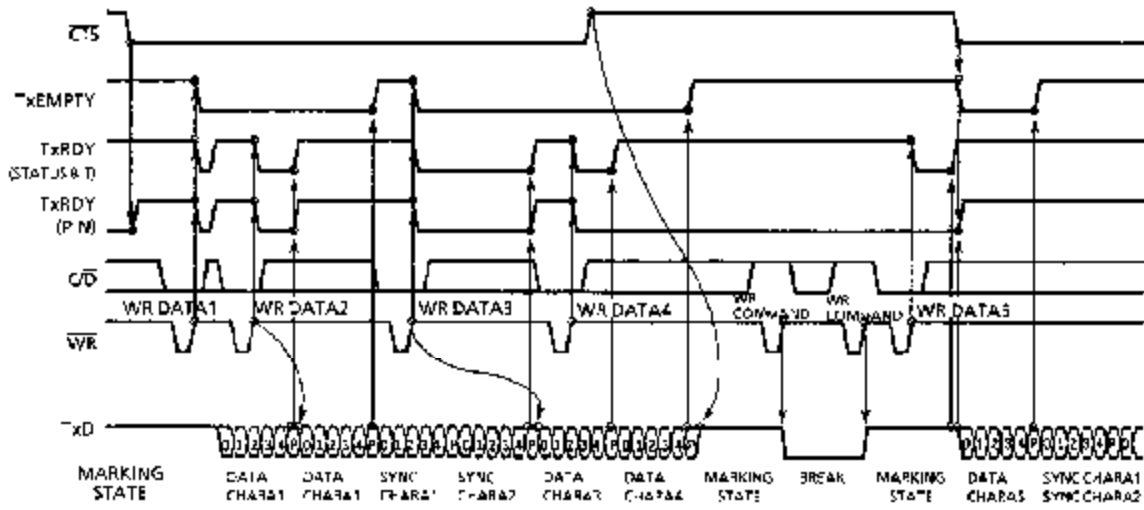
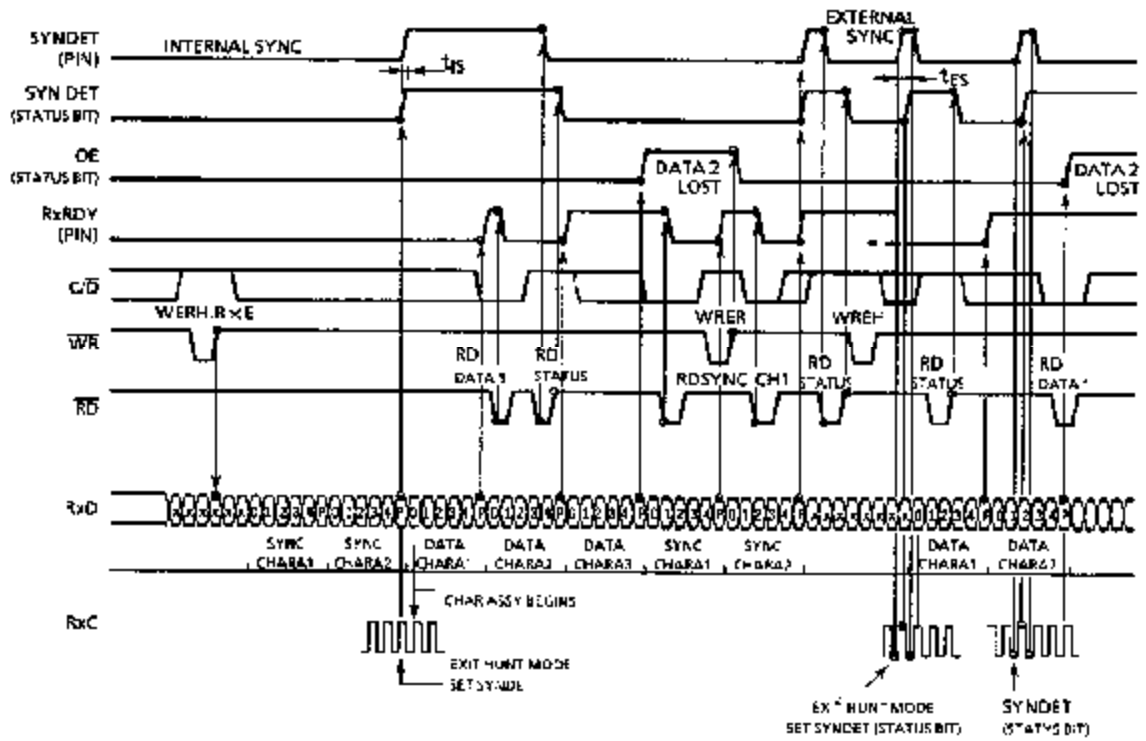

Figure 6.7 Read Control or Input Port Cycle (8251A→MPU)



EXAMPLE FORMAT : 5 BIT CHARACTER WITH PARITY 2 SYNC CHARACTERS

Figure 6.8 Transmitter Control and Flag Timing (SYNC Mode)



EXAMPLE FORMAT: 5 BIT CHARACTER WITH PARITY 2 SYNC CHARACTERS.

Figure 6.9 Receiver Control and Flag Timing (SYNC Mode)

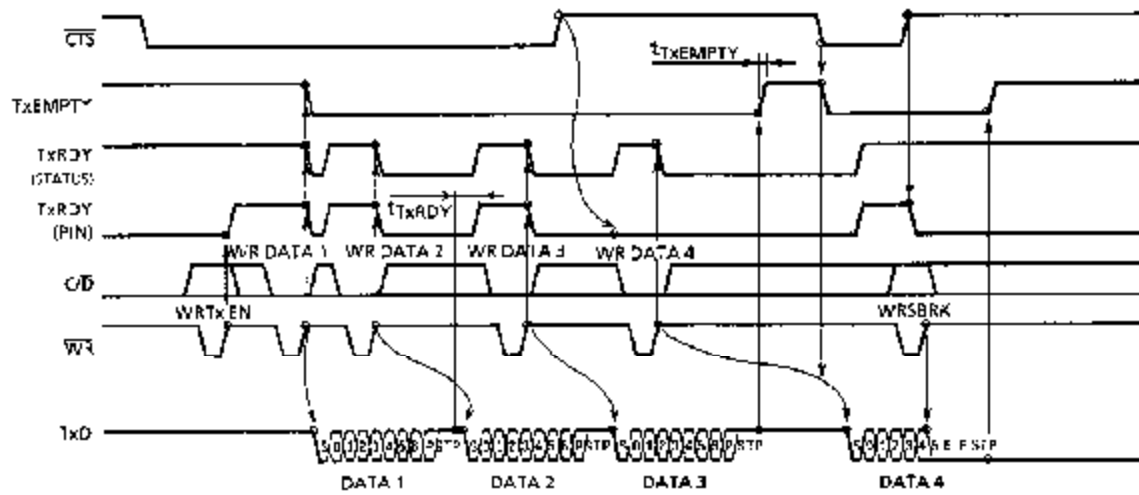

EXAMPLE FORMAT : 7 B + CHARACTER & 2 STOP BITS

Note: TxRDY (PIN) = (Transmit Data Buffer is empty) · (TxEN = 1) · (CTS = 0)
 TxRDY (STATUS BIT) = (Transmit Data Buffer is empty)

Figure 6.10 Transmitter Control and Flag Timing (SYNC Mode)

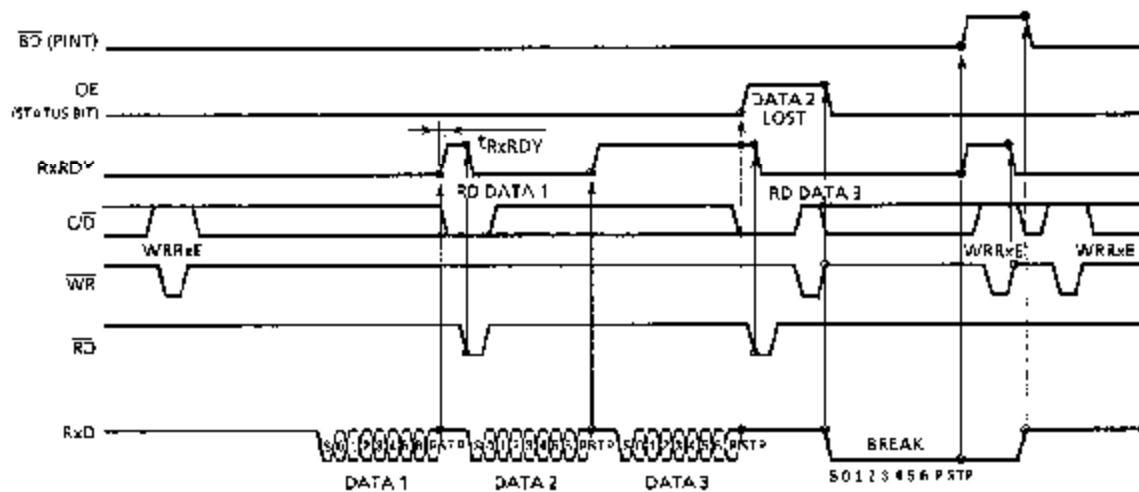

EXAMPLE FORMAT : 7 BIT CHARACTER & 2 STOP BITS.

Figure 6.11 Receiver Control and Flag Timing (ASYNC Mode)

7. OUTLINE DRAWING (Dual Inline Package)

DIP28-P-600

Unit : mm

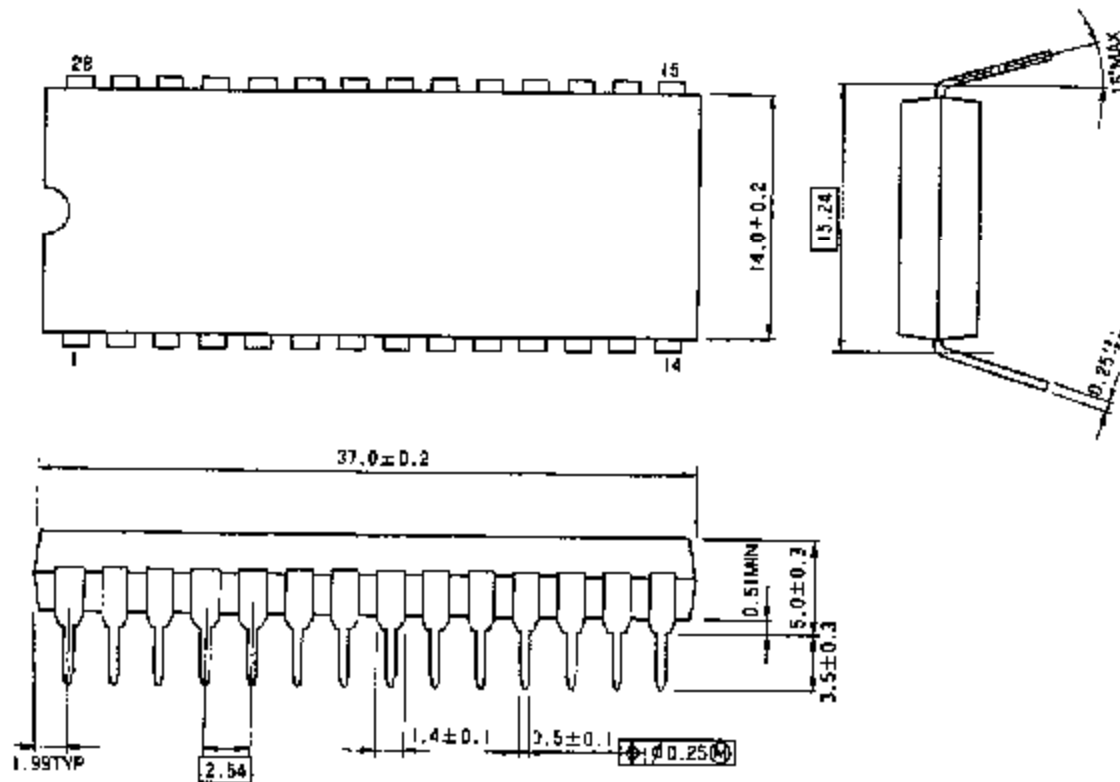

Note: Lead pitch is 2.54mm and tolerance is ± 0.25 mm against theoretical center of each lead that is obtained on the basis of No.1 and No.28 leads.