

CMOS 8-Bit Microcontroller

TMP87PM29U, TMP87PM29N

The 87PM29 is an One-Time PROM microcontroller with low-power 256 K bits (32 Kbytes) electrically programmable read only memory for 87CH29/CK29/CM29 system evaluation. The 87PM29 is pin-compatible with 87CH29/CK29/CM29. The operations possible with the 87CH29/CK29/CM29 can be performed by writing programs to PROM. The 87PM29 can write and verify in the same way as the TC57256AD using an adaptor socket BM11117/BM11143 and an EPROM programmer.

Part No.	OTP	RAM	Package	Adapter Socket
TMP87PM29U	32 K x 8-bit	1K x 8-bit	P-LQFP64-1010-0.50	BM11117
* TMP87PM29N			P-SDIP64-750-1.78	BM11143

* ; Under development

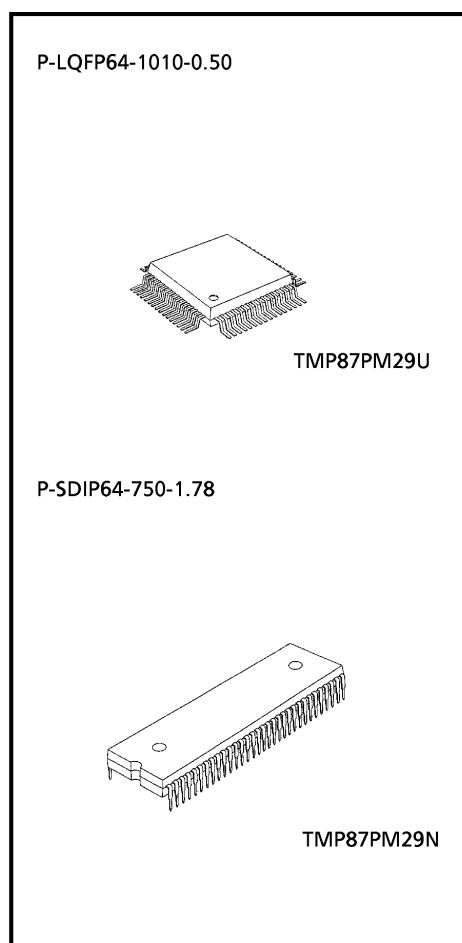

980910EBP1

- For a discussion of how the reliability of microcontrollers can be predicted, please refer to Section 1.3 of the chapter entitled Quality and Reliability Assurance/Handling Precautions.
- TOSHIBA is continually working to improve the quality and the reliability of its products. Nevertheless, semiconductor devices in general can malfunction or fail due to their inherent electrical sensitivity and vulnerability to physical stress. It is the responsibility of the buyer, when utilizing TOSHIBA products, to observe standards of safety, and to avoid situations in which a malfunction or failure of a TOSHIBA product could cause loss of human life, bodily injury or damage to property. In developing your designs, please ensure that TOSHIBA products are used within specified operating ranges as set forth in the most recent products specifications. Also, please keep in mind the precautions and conditions set forth in the TOSHIBA Semiconductor Reliability Handbook.
- The products described in this document are subject to the foreign exchange and foreign trade laws.
- The information contained herein is presented only as a guide for the applications of our products. No responsibility is assumed by TOSHIBA CORPORATION for any infringements of intellectual property or other rights of the third parties which may result from its use. No license is granted by implication or otherwise under any intellectual property or other rights of TOSHIBA CORPORATION or others.
- The information contained herein is subject to change without notice.

Pin Assignments (Top View)

P-LQFP64-1010-0.50

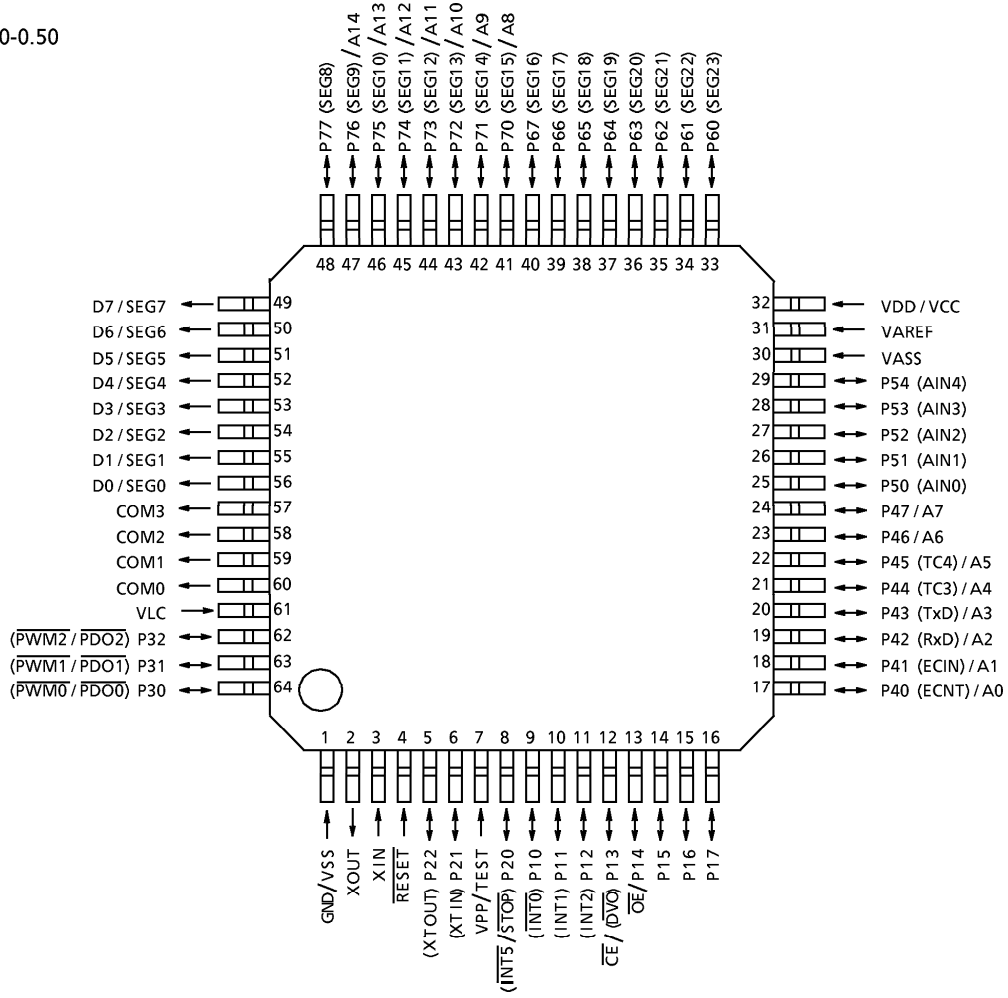

P-SDIP64-750-1.78

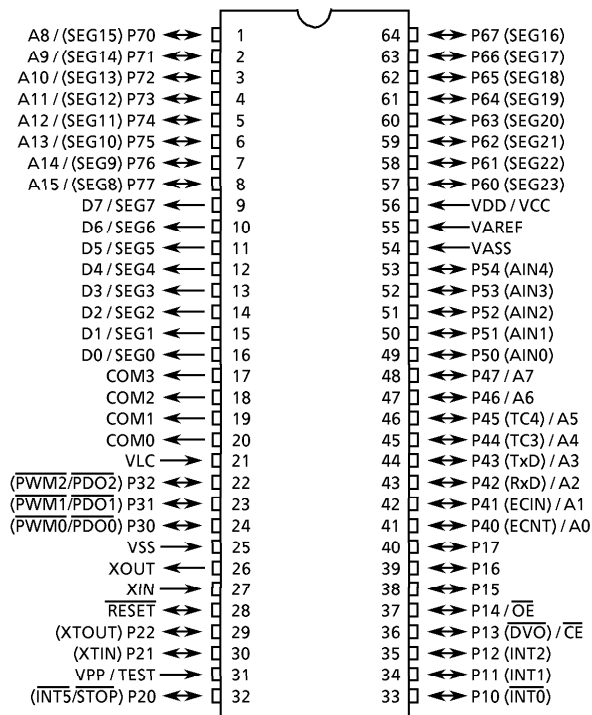

Pin Function

The 87PM29 has two modes: MCU and PROM.

(1) MCU mode

In this mode, the 87PM29 is pin-compatible with the 87CH29/CK29/CM29 (fix the TEST / VPP pin at low level).

(2) PROM mode

Pin Name (PROM mode)	Input / Output	Functions	Pin Name (MCU mode)
A14 to A8	Input	PROM address inputs	P76 to P70
A7 to A0			P47 to P40
D7 to D0	I/O	PROM data input/outputs	SEG7 to SEG0
\overline{CE}	Input	Chip enable signal input (active low)	P13
\overline{OE}		Output enable signal input (active low)	P14
VPP	Power supply	+ 12.5 V / 5 V (Program supply voltage)	TEST
VCC		+ 5 V	VDD
GND		0 V	VSS
P32 to P30	I/O	Pull-up with resistance for input processing.	
P54 to P50			
P67 to P60			
P11		PROM mode setting pins. Fix at high level.	
P21			
P77			
P12, P10		PROM mode setting pins. Fix at low level.	
P17 to P15			
P22, P20			
RESET			
XIN	Input	Connect an 8MHz oscillator to stabilize the internal state.	
XOUT	Output		
COM3 to COM0	Output	Open.	
VLC	LCD power supply		
VASS	Power supply	0 V (GND)	
VAREF			

OPERATIONAL DESCRIPTION

The following explains the 87PM29 hardware configuration and operation. The configuration and functions of the 87PM29 are the same as those of the 87CH29/CK29/CM29, except in that a one-time PROM is used instead of an on-chip mask ROM.

The 87PM29 is placed in the single-clock mode during reset. To use the dual-clock mode, the low-frequency oscillator should be turned on by executing [SET (SYSCR2). XTEN] instruction at the beginning of the program.

1. OPERATION MODE

The 87PM29 has two modes: MCU and PROM.

1.1 MCU Mode

The MCU mode is activated by fixing the TEST / VPP pin at low level.

In the MCU mode, operation is the same as with the 87CH29/CK29/CM29 (the TEST / VPP pin cannot be used open because it has no built-in pull-down resistance).

1.1.1 Program Memory

The 87PM29 has a 32K × 8-bit (addresses 8000_H - FFFF_H in the MCU mode, addresses 0000_H - 7FFF_H in the PROM mode) of program memory (OTP).

To use the 87PM29 as the system evaluation for the 87CH29/K29/M29U/N, the program should be written to the program memory area as shown in Figure 1-1.

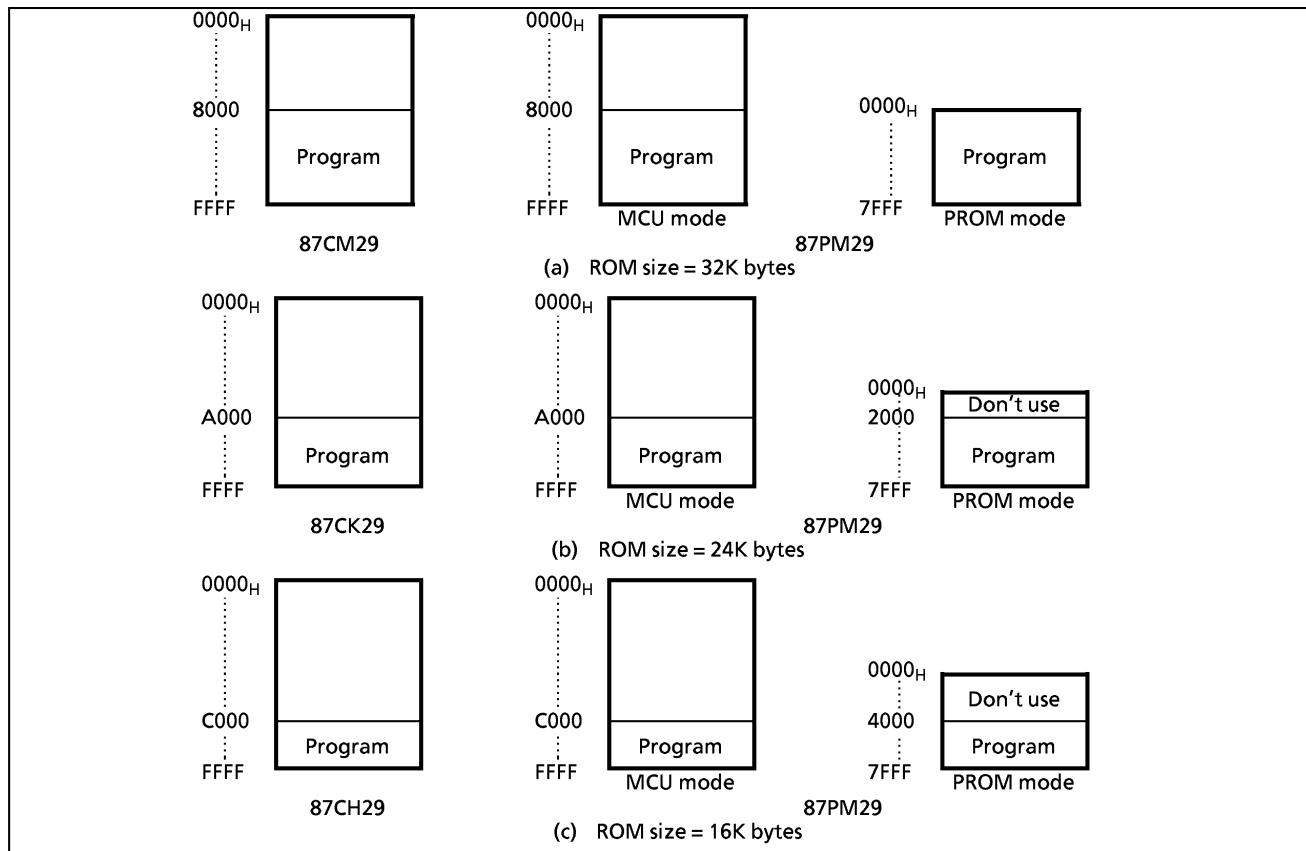

Figure 1-1. Program Memory Area

Note : Either write the data FF_H to the unused area or set the PROM programmer to access only the program storage area

1.1.2 Data Memory

The 87PM29 has an on-chip 1K × 8-bit data memory (static RAM).

Electrical Characteristics

(2) 87PM29

Absolute Maximum Ratings

 $(V_{SS} = 0\text{ V})$

Parameter	Symbol	Conditions	Ratings	Unit
Supply Voltage	V_{DD}		- 0.3 to 6.5	V
Program Voltage	V_{PP}	TEST/VPP pin	- 0.3 to 13.0	V
Input Voltage	V_{IN}		- 0.3 to $V_{DD} + 0.3$	V
Output Voltage	V_{OUT1}	P21, P22, $\overline{\text{RESET}}$, Tri-state port, and Push-pull port	- 0.3 to $V_{DD} + 0.3$	V
	V_{OUT2}	P20, port P3 and segment port	- 0.3 to 5.5	
Output Current (Per 1 pin)	I_{OUT1}	Ports P1,P2,P4,P5,P6,P7	3.2	mA
	I_{OUT2}	Port P3	30	
Output Current (Total)	ΣI_{OUT1}	Ports P1,P2,P4,P5,P6,P7	120	mA
	ΣI_{OUT2}	Port P3	60	
Power Dissipation [$T_{opr} = 70^\circ\text{C}$]	PD	TMP87PM29N	600	mW
		TMP87PM29U	350	
Soldering Temperature (time)	T_{sld}		260 (10 s)	$^\circ\text{C}$
Storage Temperature	T_{stg}		- 55 to 125	$^\circ\text{C}$
Operating Temperature	T_{opr}		- 30 to 70	$^\circ\text{C}$

Note: The absolute maximum ratings are rated values which must not be exceeded during operation, even for an instant. Any one of the ratings must not be exceeded. If any absolute maximum rating is exceeded, a device may break down or its performance may be degraded, causing it to catch fire or explode resulting in injury to the user. Thus, when designing products which include this device, ensure that no absolute maximum rating value will ever be exceeded.

Recommended Operating Conditions

 $(V_{SS} = 0\text{ V}, T_{opr} = -30\text{ to }70^\circ\text{C})$

Parameter	Symbol	Pins	Conditions	Min	Max	Unit	
Supply Voltage	V_{DD}		$f_c = 8\text{ MHz}$	NORMAL1, 2 mode	4.5	5.5	V
				IDLE1, 2 mode			
			$f_c = 4.2\text{ MHz}$	NORMAL1, 2 mode	2.7		
				IDLE1, 2 mode			
			$f_s = 32.768\text{ kHz}$	SLOW mode	2.0		
				SLEEP mode			
	STOP mode						
Input High Voltage	V_{IH1}	Except hysteresis input	$V_{DD} \geq 4.5\text{ V}$	$V_{DD} \times 0.70$	V_{DD}	V	
	V_{IH2}	Hysteresis input		$V_{DD} \times 0.75$			
	V_{IH3}			$V_{DD} < 4.5\text{ V}$			$V_{DD} \times 0.90$
Input Low Voltage	V_{IL1}	Except hysteresis input	$V_{DD} \geq 4.5\text{ V}$	0	$V_{DD} \times 0.30$	V	
	V_{IL2}	Hysteresis input		$V_{DD} \times 0.25$			
	V_{IL3}			$V_{DD} < 4.5\text{ V}$	$V_{DD} \times 0.10$		
Clock Frequency	f_c	XIN, XOUT	$V_{DD} = 4.5\text{ to }5.5\text{ V}$	0.4	8.0	MHz	
			$V_{DD} = 2.7\text{ to }5.5\text{ V}$		4.2		
	f_s	XTIN, XTOUT		30.0	34.0	kHz	

Note 1: The recommended operating conditions for a device are operating conditions under which it can be guaranteed that the device will operate as specified. If the device is used under operating conditions other than the recommended operating conditions (supply voltage, operating temperature range, specified AC/DC values etc.), malfunction may occur. Thus, when designing products which include this device, ensure that the recommended operating conditions for the device are always adhered to.

Note 2: Clock frequency f_c : The supply voltage range of the conditions shows the value in NORMAL 1, 2 modes and IDLE 1, 2 modes.

D.C.Characteristics

(V_{SS} = 0 V, T_{opr} = - 30 to 70°C)

Parameter	Symbol	Pins	Conditions	Min	Typ.	Max	Unit						
Hysteresis Voltage	V _{HS}	Hysteresis input		—	0.9	—	V						
Input Current	I _{IN1}	TEST	V _{DD} = 5.5 V V _{IN} = 5.5 V / 0 V	—	—	± 2	μA						
	I _{IN2}	Sink open drain port and tri-state port											
	I _{IN3}	RESET, $\overline{\text{STOP}}$											
Input Low Current	I _{IL}	Push-pull port	V _{DD} = 5.5 V, V _{IN} = 0.4 V	—	—	-2	mA						
Input Resistance	R _{IN}	RESET		100	220	450	kΩ						
Output Leakage Current	I _{LO}	Sink open drain port and tri-state port	V _{DD} = 5.5 V, V _{OUT} = 5.5 V	—	—	2	μA						
Output High Voltage	V _{OH1}	Push-pull port	V _{DD} = 4.5 V, I _{OH} = - 200 μA	2.4	—	—	V						
	V _{OH2}	Tri- state port	V _{DD} = 4.5 V, I _{OH} = - 0.7 mA	4.1	—	—							
Output Low Voltage	V _{OL}	Except XOUT and port P3	V _{DD} = 4.5 V, I _{OL} = 1.6 mA	—	—	0.4	V						
Output Low Current	I _{OL}	Only P30, P31, P32	V _{DD} = 4.5 V, V _{OL} = 1.0 V	—	20	—	mA						
Supply Current in NORMAL 1, 2 mode	I _{DD}		V _{DD} = 5.5 V f _c = 8 MHz f _s = 32.768 kHz V _{IN} = 5.3 V / 0.2 V	—	10	16	mA						
Supply Current in IDLE 1, 2 mode								—	4.5	6	mA		
Supply Current in SLOW mode								—	30	60	μA		
Supply Current in SLEEP mode								—	15	30	μA		
Supply Current in STOP mode								—	0.5	10	μA		
Segment Output Low Resistance	R _{OS1}	SEG23 to SEG0 pins	V _{DD} = 5 V V _{DD} - V _{LC} = 3 V	—		RESL = 0 (Note 11)	20	kΩ					
						RSEL = 1	7						
Common Output Low Resistance	R _{OC1}	COM3 to COM0 pins				RESL = 0	20						
						RSEL = 1	7						
Segment Output High Resistance	R _{OS2}	SEG23 to SEG0 pins				RESL = 0	200						
						RSEL = 1	70						
Common Output High Resistance	R _{OC2}	COM3 to COM0 pins				RESL = 0	200						
						RSEL = 1	70						
Segment /Common Output Voltage	V _{O 2/3}	SEG23 to SEG0 and COM3 to COM0 pins									3.8	4.0	4.2
	V _{O 1/2}										3.3	3.5	3.7
	V _{O 1/3}		2.8	3.0	3.2								

- Note 1: Typical value show those at T_{opr} = 25°C, V_{DD} = 5 V.
 Note 2: Input Current ; The current through pull-up or pull-down resistor is not included.
 Note 3: I_{DD} ; Except for I_{REF}
 Note 4: Output resistors R_{OS}, R_{OC} indicate "on" when switching levels.
 Note 5: V_{O2/3} indicates an output current at the 2/3 level when operating in the 1/4 or 1/3 duty mode.
 Note 6: V_{O1/2} indicates an output current at the 1/2 level when operating in the 1/2 duty or static mode.
 Note 7: V_{O1/3} indicates an output current at the 1/3 level when operating in the 1/4 or 1/3 duty mode.
 Note 8: When you use a liquid crystal display (LCD), it is necessary to give careful consideration to the value of the output resistor R_{OS 1/2}, R_{OC 1/2}.
 Note 9: R_{OS1}, R_{OC1}: On time of the lower output resistor is 2⁷/f_c, 1/(2-f_s) [s].
 Note 10: R_{OS2}, R_{OC2}: On time of the higher output resistor is 1/(n·f_r). (1/n duty, f_r: frame frequency)
 Note 11: RSEL ; Bit 6 in LCDCR

A / D Conversion Characteristics

($V_{SS} = 0\text{ V}$, $V_{DD} = 2.7\text{ to }5.5\text{ V}$, $T_{opr} = -30\text{ to }70^\circ\text{C}$)

Parameter	Symbol	Conditions	Min	Typ.	Max	Unit
Analog Reference Voltage	V_{AREF}	$V_{AREF} - V_{ASS} \geq 2.5\text{ V}$	2.7	—	V_{DD}	V
	V_{ASS}		V_{SS}	—	1.5	
Analog Input Voltage	V_{AIN}		V_{ASS}	—	V_{AREF}	V
Analog Supply Current	I_{REF}	$V_{AREF} = 5.5\text{ V}$, $V_{ASS} = 0.0\text{ V}$	—	0.5	1.0	mA
Nonlinearity Error		$V_{DD} = 5.0\text{ V}$, $V_{SS} = 0.0\text{ V}$ $V_{AREF} = 5.000\text{ V}$ $V_{ASS} = 0.000\text{ V}$	—	—	± 1	LSB
Zero Point Error		or $V_{DD} = 2.7\text{ V}$, $V_{SS} = 0.0\text{ V}$ $V_{AREF} = 2.700\text{ V}$ $V_{ASS} = 0.000\text{ V}$	—	—	± 1	
Full Scale Error			—	—	± 2	

Note: Quantizing error is not contained in those errors.

A.C. Characteristics

($V_{SS} = 0\text{ V}$, $V_{DD} = 4.5\text{ to }5.5\text{ V}$, $T_{opr} = -30\text{ to }70^\circ\text{C}$)

Parameter	Symbol	Conditions	Min	Typ.	Max	Unit
Machine Cycle Time	t_{cy}	In NORMAL 1, 2 mode	0.5	—	10	μs
		In IDLE 1, 2 mode				
		In SLOW mode	117.6	—	133.3	
		In SLEEP mode				
High Level Clock Pulse Width	t_{WCH}	For external clock operation (XIN input), $f_c = 8\text{ MHz}$	50	—	—	ns
Low Level Clock Pulse Width	t_{WCL}					
High Level Clock Pulse Width	t_{WSH}	For external clock operation (XTIN input), $f_s = 32.768\text{ kHz}$	14.7	—	—	μs
Low Level Clock Pulse Width	t_{WSL}					

($V_{SS} = 0\text{ V}$, $T_{opr} = -30\text{ to }70^\circ\text{C}$)

Parameter	Symbol	Conditions	Min	Typ.	Max	Unit	
TC1 input (ECIN input)	t_{TC1}	$V_{DD} = 4.5\text{ to }5.5\text{ V}$	Frequency measurement mode Single edge count	—	—	8	MHz
			Both edge count	—	—	4	
		$V_{DD} = 2.7\text{ to }5.5\text{ V}$	Frequency measurement mode Single edge count	—	—	4.2	
			Both edge count	—	—	3	

Recommended Oscillating Condition

($V_{SS} = 0\text{ V}$, $V_{DD} = 4.5\text{ to }5.5\text{ V}$, $T_{opr} = -30\text{ to }70^\circ\text{C}$)

Parameter	Oscillator	Frequency	Recommended Oscillator		Recommended Condition	
					C ₁	C ₂
High-frequency	Ceramic Resonator	8 MHz	KYOCERA	KBR8.0M	30pF	30pF
		4 MHz	KYOCERA	KBR4.0MS		
			MURATA	CSA4.00MG		
	Crystal Oscillator	8 MHz	TOYOCOM	210B 8.0000	20pF	20pF
4 MHz		TOYOCOM	204B 4.0000			
Low-frequency	Crystal Oscillator	32.768 kHz	NDK	MX-38T	15pF	15pF

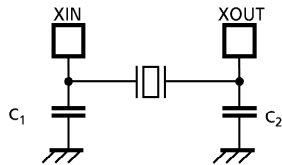

(1) High-frequency

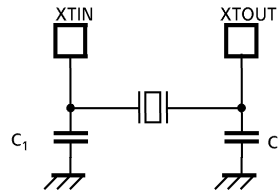

(2) Low-frequency

Note: When it is used in high electrical field, an electrical shield of the package is recommended to retain normal operations.

D.C./A.C. Characteristics (PROM mode) ($V_{SS} = 0\text{ V}$)

(1) Read Operation ($T_{opr} = -30\text{ to }70^{\circ}\text{C}$)

Parameter	Symbol	Condition	Min	Typ.	Max	Unit
Input High Voltage	V_{IH4}		$V_{CC} \times 0.7$	–	V_{CC}	V
Input Low Voltage	V_{IL4}		0	–	$V_{CC} \times 0.12$	V
Power Supply Voltage	V_{CC}		4.75	5.00	5.25	V
Program Power Supply Voltage	V_{PP}		$V_{CC} - 0.6$	V_{CC}	$V_{CC} + 0.6$	
Address Access Time	t_{ACC}	$V_{CC} = 5.0 \pm 0.25\text{ V}$	–	$1.5\text{ }t_{cyc} + 300$	–	ns

Note: $t_{cyc} = 500\text{ ns}$ at 8 MHz

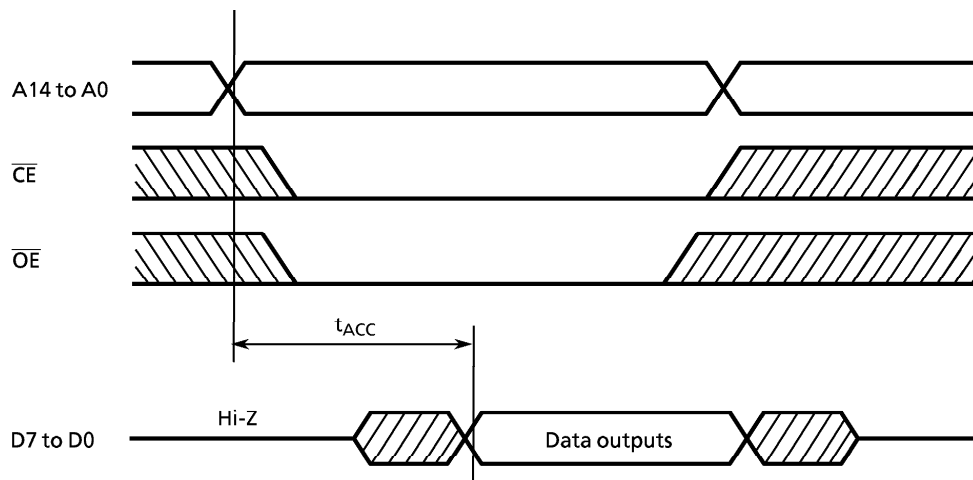

Timing Waveforms of Read Operation

(2) High-Speed Programming I Operation ($T_{opr} = 25 \pm 5^{\circ}\text{C}$)

Parameter	Symbol	Condition	Min	Typ.	Max	Unit
Input High Voltage	V_{IH4}		$V_{CC} \times 0.7$	–	V_{CC}	V
Input Low Voltage	V_{IL4}		0	–	$V_{CC} \times 0.12$	V
Power Supply Voltage	V_{CC}		5.75	6.0	6.25	V
Program Power Supply Voltage	V_{PP}		12.0	12.5	13.0	V
Initial Program Pulse Width	t_{PW}	$V_{CC} = 6.0\text{ V}, \pm 0.25\text{ V}$ $V_{PP} = 12.5 \pm 0.5\text{ V}$	0.95	1.0	1.05	ms

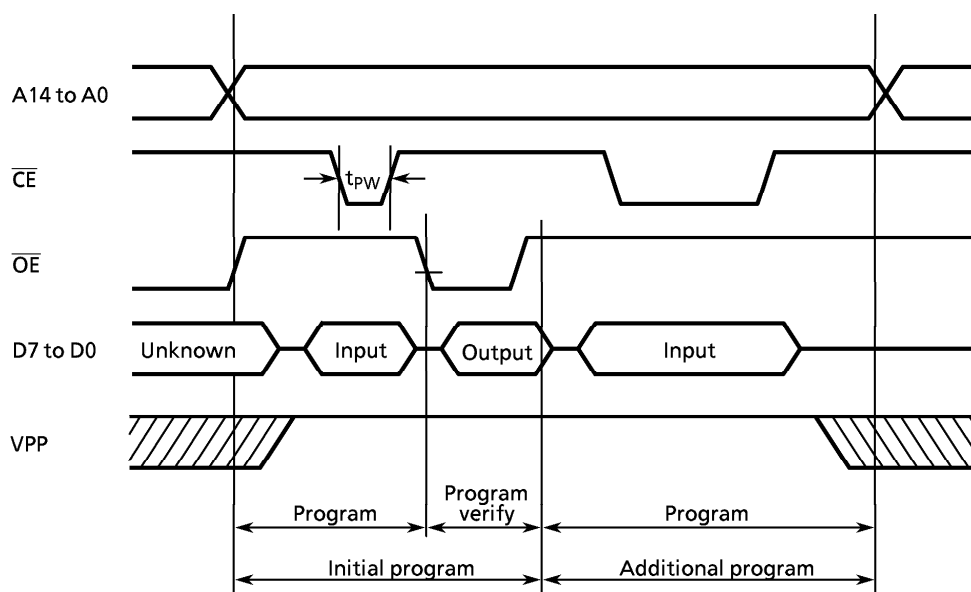

Timing Waveforms of Programming Operation

- Note 1:** V_{pp} (12.5 V) supply is applied at the same time as V_{cc} supply or later. It is turned off at the same or earlier.
- Note 2:** When a device is put on or off at $V_{PP} = 12.5\text{ V} \pm 0.5\text{ V}$, the device may be damaged. Do not put it on or off in programming.
- Note 3:** Use the recommended adapter and mode. When using under other than these conditions, it may be not programmed.

(3) High-Speed Programming II Operation ($T_{opr} = 25 \pm 5^{\circ}\text{C}$)

Parameter	Symbol	Condition	Min	Typ.	Max	Unit
Input High Voltage	V_{IH4}		$V_{CC} \times 0.7$	–	V_{CC}	V
Input Low Voltage	V_{IL4}		0	–	$V_{CC} \times 0.12$	V
Power Supply Voltage	V_{CC}		6.00	6.25	6.50	V
Program Power Supply Voltage	V_{PP}		12.50	12.75	13.0	V
Initial Program Pulse Width	t_{PW}	$V_{CC} = 6.25\text{V} \pm 0.25\text{V}$, $V_{PP} = 12.75 \pm 0.25\text{V}$	0.095	0.1	0.105	ms

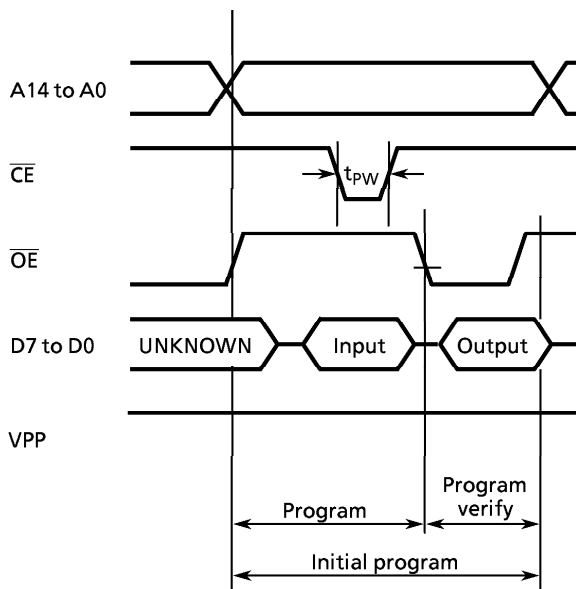

- Note 1: V_{pp} (12.75 V) supply is applied at the same time as V_{cc} supply or later. It is turned off at the same or earlier.
- Note 2: When a device is put on or off at $V_{PP} = 12.75\text{V} \pm 0.25\text{V}$, the device may be damaged. Do not put it on or off in programming.
- Note 3: Use the recommended adapter and mode. When using under other than these conditions, it may be not programmed.

