

## CMOS 8-Bit Microcontroller

**TMP88PS38N/F**

The TMP88PS38 is the high-speed and high performance 8-bit signal chip microcomputers which built in a program storage area (64 Kbytes), an OSD font storage area (24 Kbytes) and the One-Time PROM of vector table storage area (256 bytes). The TMP88PS38 is pin compatible with the TMP88CS38. The operation possible with the TMP88PS38 can be performed by writing programs to PROM. The TMP88PS38 can write and verify in the same way as the TC571000D an EPROM programmer.

Product No.	OTP	RAM	Package	Adaptor Socket
TMP88PS38N	64 Kbytes (256 bytes)	2 Kbytes	P-SDIP42-600-1.78	BM11174
TMP88PS38F	24 Kbytes		P-QFP44-1414-0.80D	BM11175

000707EBP1

- For a discussion of how the reliability of microcontrollers can be predicted, please refer to Section 1.3 of the chapter entitled Quality and Reliability Assurance / Handling Precautions.
- TOSHIBA is continually working to improve the quality and reliability of its products. Nevertheless, semiconductor devices in general can malfunction or fail due to their inherent electrical sensitivity and vulnerability to physical stress. It is the responsibility of the buyer, when utilizing TOSHIBA products, to comply with the standards of safety in making a safe design for the entire system, and to avoid situations in which a malfunction or failure of such TOSHIBA products could cause loss of human life, bodily injury or damage to property.  
In developing your designs, please ensure that TOSHIBA products are used within specified operating ranges as set forth in the most recent TOSHIBA products specifications. Also, please keep in mind the precautions and conditions set forth in the "Handling Guide for Semiconductor Devices," or "TOSHIBA Semiconductor Reliability Handbook" etc..
- The TOSHIBA products listed in this document are intended for usage in general electronics applications (computer, personal equipment, office equipment, measuring equipment, industrial robotics, domestic appliances, etc.). These TOSHIBA products are neither intended nor warranted for usage in equipment that requires extraordinarily high quality and/or reliability or a malfunction or failure of which may cause loss of human life or bodily injury ("Unintended Usage"). Unintended Usage include atomic energy control instruments, airplane or spaceship instruments, transportation instruments, traffic signal instruments, combustion control instruments, medical instruments, all types of safety devices, etc.. Unintended Usage of TOSHIBA products listed in this document shall be made at the customer's own risk.
- The products described in this document are subject to the foreign exchange and foreign trade laws.
- The information contained herein is presented only as a guide for the applications of our products. No responsibility is assumed by TOSHIBA CORPORATION for any infringements of intellectual property or other rights of the third parties which may result from its use. No license is granted by implication or otherwise under any intellectual property or other rights of TOSHIBA CORPORATION or others.
- The information contained herein is subject to change without notice.



Purchase of TOSHIBA I<sup>2</sup>C components conveys a license under the Philips I<sup>2</sup>C Patent Rights to use these components in an I<sup>2</sup>C system, provided that the system conforms to the I<sup>2</sup>C Standard Specification as defined by Philips.

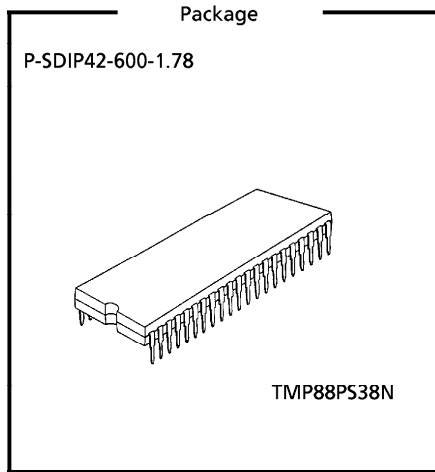

Pin Assignments

P-SDIP42-600-1.78

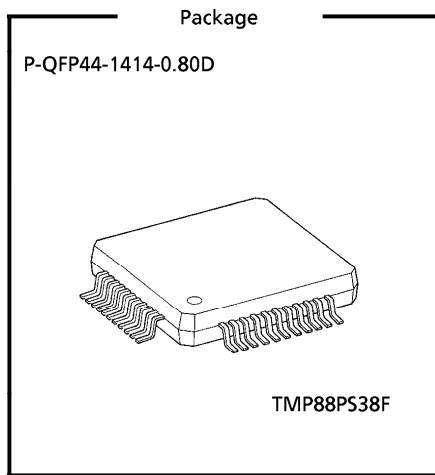
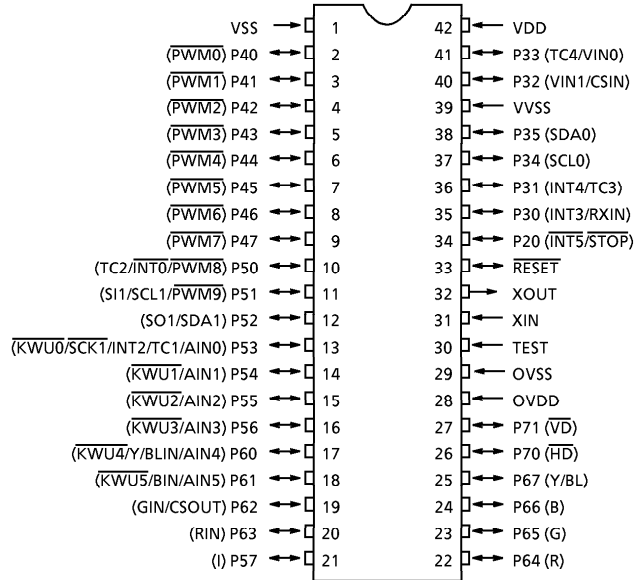

P-QFP44-1414-0.80D

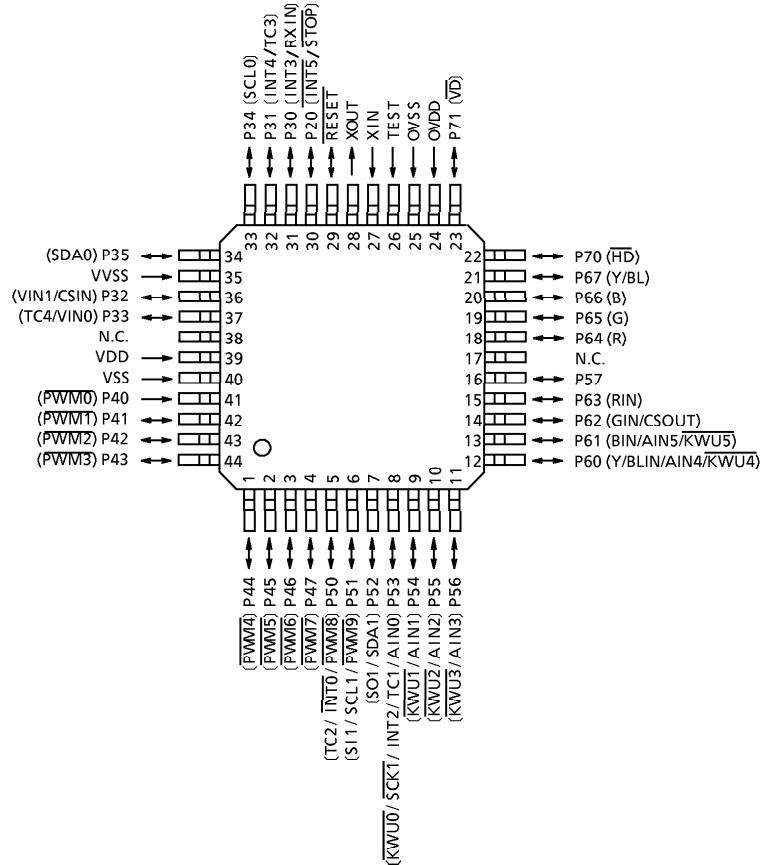

**Operational Description**

The configuration and function of the TMP88PS38 are the same as those of the TMP88CS38, except in that a one-time PROM is used instead of an on-chip mask ROM.

**1. Operation Mode**

The TMP88PS38 has two mode: MCU and PROM.

**1.1 MCU Mode**

The MCU mode is activated by fixing the TEST/VPP pin at low level.

In the MCU mode, operation is the same as with the TMP88CS38.

**1.1.1 Program Memory**

The TMP88PS38 has a 64 Kbytes (addresses 04000<sub>H</sub> to 13EFF<sub>H</sub> in the MCU mode, addresses 10000<sub>H</sub> to 1FEFF<sub>H</sub> in the PROM mode) of program storage area, 24 Kbyte (addresses 20000<sub>H</sub> to 25FFF<sub>H</sub> in the MCU mode, addresses 0A000<sub>H</sub> to 0FFFF<sub>H</sub> in the PROM mode) and 256 byte (addresses FFF00<sub>H</sub> to FFFFF<sub>H</sub> in the MCU mode, addresses 1FF00<sub>H</sub> to 1FFFF<sub>H</sub> in the PROM mode) one-time PROM of vector table storage area.

## Electrical Characteristics

Absolute maximum ratings		(V <sub>SS</sub> = 0 V)		
Parameter	Symbol	Pins	Ratings	Unit
Supply Voltage	V <sub>DD</sub>	—	– 0.3 to 6.5	V
Programmable Voltage	V <sub>pp</sub>	TEST/V <sub>pp</sub> Pin	– 0.3 to 13.0	
Input Voltage	V <sub>IN</sub>	—	– 0.3 to V <sub>DD</sub> + 0.3	
Output Voltage	V <sub>OUT1</sub>	—	– 0.3 to V <sub>DD</sub> + 0.3	
Output Current (Per 1 pin)	I <sub>OUT1</sub>	Ports P2, P3, P4, P5, P64 to P67, P7	3.2	mA
	I <sub>OUT2</sub>	Ports P60 to P63	30	
Output Current (Total)	∑ I <sub>OUT1</sub>	Ports P2, P3, P4, P5, P64 to P67, P7	120	
	∑ I <sub>OUT2</sub>	Ports P60 to P63	120	
Power Dissipation [Topr = 70°C]	PD	—	600	mW
Soldering Temperature (time)	T <sub>sld</sub>	—	260 (10 s)	°C
Storage Temperature	T <sub>stg</sub>	—	– 55 to 125	
Operating Temperature	Topr	—	– 30 to 70	

Note: The absolute maximum ratings are rated values which must not be exceeded during operation, even for an instant. Any one of the ratings must not be exceeded. If any absolute maximum rating is exceeded, a device may break down or its performance may be degraded, causing it to catch fire or explode resulting in injury to the user. Thus, when designing products which include this device, ensure that no absolute maximum rating value will ever be exceeded.

Recommended operating conditions		(V <sub>SS</sub> = 0 V, Topr = –30 to 70°C)				
Parameter	Symbol	Pins	Conditions	Min	Max	Unit
Supply Voltage	V <sub>DD</sub>	—	fc = 16 MHz   NORMAL mode	4.5	5.5	V
			fc = 16 MHz   IDLE mode			
			—   STOP mode			
Input High Voltage	V <sub>IH1</sub>	Except hysteresis input	V <sub>DD</sub> = 4.5 to 5.5 V	V <sub>DD</sub> × 0.70	V <sub>DD</sub>	V
	V <sub>IH2</sub>	Hysteresis input		V <sub>DD</sub> × 0.75		
Input Low Voltage	V <sub>IL1</sub>	Except hysteresis input	V <sub>DD</sub> = 4.5 to 5.5 V	0	V <sub>DD</sub> × 0.30	V
	V <sub>IL2</sub>	Hysteresis input			V <sub>DD</sub> × 0.25	
	V <sub>IL4</sub>	Key-on Wake-up input			V <sub>DD</sub> × 0.65	
Clock Frequency	fc	XIN, XOUT	V <sub>DD</sub> = 4.5 to 5.5 V	8.0	16.0	MHz
	f <sub>OSC</sub>	Internal clock	V <sub>DD</sub> = 4.5 to 5.5 V	fc = 8 MHz 16.0	12.0 24.0	

Note 1: The recommended operating conditions for a device are operating conditions under which it can be guaranteed that the device will operate as specified. If the device is used under operating conditions other than the recommended operating conditions (supply voltage, operating temperature range, specified AC/DC values etc.), malfunction may occur. Thus, when designing products which include this device, ensure that the recommended operating conditions for the device are always adhered to.

Note 2: Clock frequency fc ; Supply voltage range is specified in NORMAL mode and IDLE mode.

Note 3: Smaller value is alternatively specified as the maximum value.

## DC Characteristics

 $(V_{SS} = 0\text{ V}, T_{opr} = -30\text{ to }70^{\circ}\text{C})$ 

Parameter	Symbol	Pins	Conditions	Min	Typ.	Max	Unit
Hysteresis Voltage	$V_{HS}$	Hysteresis inputs		–	0.9	–	V
Input Current	$I_{IN1}$	TEST	$V_{DD} = 5.5\text{ V}, V_{IN} = 5.5\text{ V}/0\text{ V}$	–	–	$\pm 2$	$\mu\text{A}$
	$I_{IN2}$	Open drain ports	$V_{DD} = 5.5\text{ V}, V_{IN} = 5.5\text{ V}/0\text{ V}$	–	–	$\pm 2$	
	$I_{IN3}$	Tri-state ports	$V_{DD} = 5.5\text{ V}, V_{IN} = 5.5\text{ V}/0\text{ V}$	–	–	$\pm 2$	
	$I_{IN4}$	RESET, STOP	$V_{DD} = 5.5\text{ V}, V_{IN} = 5.5\text{ V}/0\text{ V}$	–	–	$\pm 2$	
Input Resistance	$R_{IN2}$	RESET	$V_{DD} = 5.5\text{ V}, V_{IN} = 0\text{ V}$	100	220	450	$\text{k}\Omega$
Output Leakage Current	$I_{LO1}$	Sink open drain ports	$V_{DD} = 5.5\text{ V}, V_{OUT} = 5.5\text{ V}$	–	–	2	$\mu\text{A}$
	$I_{LO2}$	Tri-state ports	$V_{DD} = 5.5\text{ V}, V_{OUT} = 5.5\text{ V}/0\text{ V}$	–	–	$\pm 2$	
Output High Voltage	$V_{OH2}$	Tri-state ports	$V_{DD} = 4.5\text{ V}, I_{OH} = -0.7\text{ mA}$	4.1	–	–	V
Output Low Voltage	$V_{OL}$	Except XOUT and ports P60 to P63	$V_{DD} = 4.5\text{ V}, I_{OL} = 1.6\text{ mA}$	–	–	0.4	
Output Low current	$I_{OL3}$	Port P60 to P63	$V_{DD} = 4.5\text{ V}, V_{OL} = 1.0\text{ V}$	–	20	–	mA
Supply Current in NORMAL mode	$I_{DD}$	–	$V_{DD} = 5.5\text{ V}$ $f_c = 16\text{ MHz}$ $V_{IN} = 5.3\text{ V}/0.2\text{ V}$ (Note3)	–	25	30	
Supply Current in IDLE mode				–	20	25	
Supply Current in STOP mode				–	0.5	10	$\mu\text{A}$

Note 1 : Typical values show those at  $T_{opr} = 25^{\circ}\text{C}$ ,  $V_{DD} = 5\text{ V}$ .

Note 2 : Input Current  $I_{IN3}$ ; The current through resistor is not included.

Note 3 : Supply Current  $I_{DD}$ ; The current (Typ. 0.5 mA) through ladder resistors of ADC is included in NORMAL mode and IDLE mode.

## AD Conversion Characteristics

 $(V_{SS} = 0\text{ V}, V_{DD} = 4.5\text{ V to }5.5\text{ V}, T_{opr} = -30\text{ to }70^{\circ}\text{C})$ 

Parameter	Symbol	Conditions	Min	Typ.	Max	Unit
Analog Reference Voltage	$V_{AREF}$	supplied from $V_{DD}$ pin.	–	$V_{DD}$	–	V
	$V_{ASS}$	supplied from $V_{SS}$ pin.	–	0	–	
Analog Reference Voltage Range	$\Delta V_{AREF}$	$= V_{DD} - V_{SS}$	–	$V_{DD}$	–	
Analog Input Voltage	$V_{AIN}$		$V_{SS}$	–	$V_{DD}$	LSB
Nonlinearity Error		$V_{DD} = 0.5\text{ V}$	–	–	$\pm 1$	
Zero Point Error			–	–	$\pm 2$	
Full Scale Error			–	–	$\pm 2$	
Total Error			–	–	$\pm 3$	

Note: The total error means all error except quanting error.

## AC characteristics

 $(V_{SS} = 0\text{ V}, V_{DD} = 4.5\text{ to }5.5\text{ V}, T_{opr} = -30\text{ to }70^{\circ}\text{C})$ 

Parameter	Symbol	Conditions	Min	Typ.	Max	Unit
Machine Cycle Time	$t_{cy}$	In NORMAL mode	0.5	-	1.0	$\mu\text{s}$
		In IDLE mode				
High Level Clock Pulse Width	$t_{WCH}$	For external clock operation (XIN input), $f_c = 16\text{ MHz}$	31.25	-	-	ns
Low Level Clock Pulse Width	$t_{WCL}$					

## Recommended oscillating conditions

 $(V_{SS} = 0\text{ V}, V_{DD} = 4.5\text{ to }5.5\text{ V}, T_{opr} = -30\text{ to }70^{\circ}\text{C})$ 

Parameter	Oscillator	Oscillation Frequency	Recommended Oscillator		Recommended Constant	
					$C_1$	$C_2$
High-frequency Oscillation	Ceramic Resonator	8 MHz	Murata	CSA8.00MTZ	30 pF	30 pF
		16 MHz	Murata	CSA16.00MXZ040	5 pF	5 pF

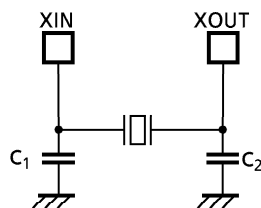

High-frequency Oscillation

**Note 1:** To keep reliable operation, shield the device electrically with the metal plate on its package mold surface against the high electric field, for example, by CRT (Cathode Ray Tube).

**Note 2:** The product numbers and specifications of the resonators by Murata Manufacturing Co., Ltd. are subject to change. For up-to-date information, please refer to the following URL;

<http://www.murata.co.jp/search/index.html>

D.C./A.C. Characteristics (PROM mode) (V<sub>SS</sub> = 0 V)

(1) Read operation (V<sub>DD</sub> = 5.0 ± 0.25 V, T<sub>opr</sub> = 25 ± 5°C)

Parameter	Symbol	Conditions	Min	Typ.	Max	Unit
Input High Voltage (A0 to A16, $\overline{CE}$ , $\overline{OE}$ , $\overline{PGM}$ )	V <sub>IH4</sub>		V <sub>DD</sub> × 0.7	–	V <sub>DD</sub>	V
Input Low Voltage (A0 to A16, $\overline{CE}$ , $\overline{OE}$ , $\overline{PGM}$ )	V <sub>IL4</sub>		0	–	0.8	
Program Power Supply Voltage	V <sub>PP</sub>		4.75	5.0	5.25	
Address Access Time	t <sub>ACC</sub>		–	1.5tcyc + 300	–	ns

Note: tcyc = 400 ns at 10 MHz

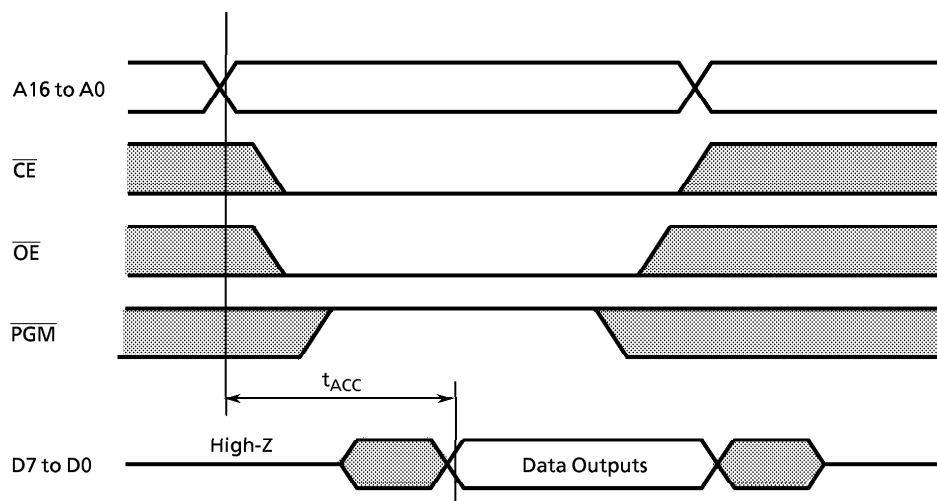

(2) High-speed programming operation (T<sub>opr</sub> = 25 ± 5°C, V<sub>DD</sub> = 6.25 ± 0.25 V)

Parameter	Symbol	Conditions	Min	Typ.	Max	Unit
Input High Voltage (D0 to D7, A0 to A16, $\overline{CE}$ , $\overline{OE}$ , $\overline{PGM}$ )	V <sub>IH4</sub>		V <sub>DD</sub> × 0.7	–	V <sub>DD</sub>	V
Input Low Voltage (D0 to D7, A0 to A16, $\overline{CE}$ , $\overline{OE}$ , $\overline{PGM}$ )	V <sub>IL4</sub>		0	–	0.8	
Program Power Supply Voltage	V <sub>PP</sub>		12.5	12.75	13.0	
Initial Program Pulse Width	t <sub>pw</sub>	V <sub>DD</sub> = 6.0 V	0.095	0.1	0.105	ms

## High-speed Programming Timing

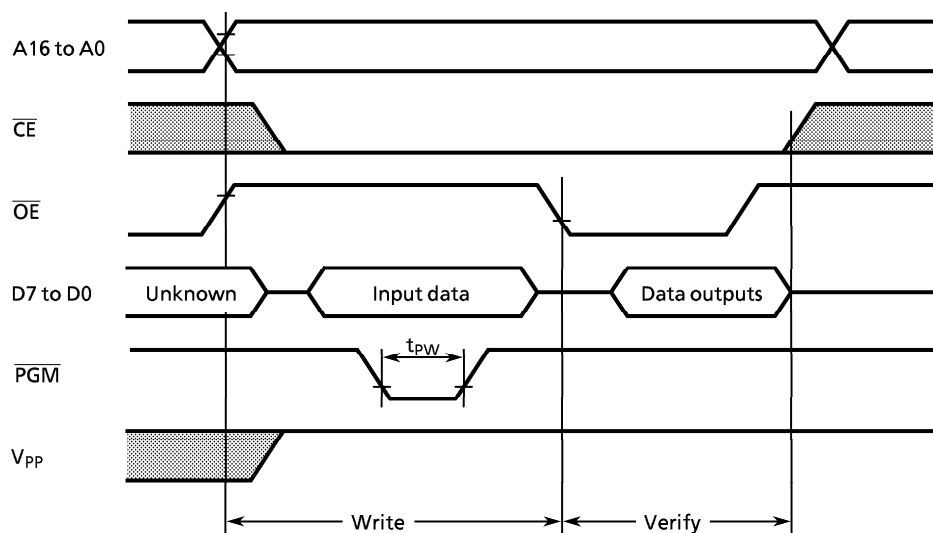

**Note1:** When  $V_{cc}$  power supply is turned on or after,  $V_{pp}$  must be increased.

When  $V_{cc}$  power supply is turned off or before,  $V_{pp}$  must be increased.

**Note2:** The device must not be set to the EPROM programmer or picked up from it under applying the program voltage ( $12.75\text{ V} \pm 0.25\text{ V}$ ) to the  $V_{pp}$  pin as the device is damaged.

**Note3:** Be sure to execute the Recommended programming mode with the Recommended programming adaptor. If a mode or an adaptor except the above, the misoperation sometimes occurs.



