

## VOLTAGE DETECTORS

### FEATURES

- Qualified for Automotive Applications
- Single Voltage Detector (TPS3803):  
Adjustable/1.5 V
- Dual Voltage Detector (TPS3805):  
Adjustable/3.3 V
- High  $\pm 1.5\%$  Threshold Voltage Accuracy
- Supply Current: 3  $\mu\text{A}$  Typical at  $V_{\text{DD}} = 3.3 \text{ V}$
- Push/Pull Reset Output (TPS3805),  
Open-Drain Reset Output (TPS3803)
- Temperature Range:  $-40^\circ\text{C}$  to  $125^\circ\text{C}$
- 5-Pin SC-70 Package

### DESCRIPTION

The TPS3803 and TPS3805 families of supervisory circuits provide circuit initialization and timing supervision, primarily for DSPs and processor-based systems.

The TPS3803G15 device has a fixed-sense threshold voltage  $V_{\text{IT}}$  set by an internal voltage divider, whereas the TPS3803-01 has an adjustable SENSE input that can be configured by two external resistors. In addition to the fixed sense threshold monitored at  $V_{\text{DD}}$ , the TPS3805 devices provide a second adjustable SENSE input.  $\overline{\text{RESET}}$  is asserted in case either of the two voltages drops below  $V_{\text{IT}}$ .

During power on,  $\overline{\text{RESET}}$  is asserted when supply voltage  $V_{\text{DD}}$  becomes higher than 0.8 V. Thereafter, the supervisory circuit monitors  $V_{\text{DD}}$  (and/or SENSE) and keeps  $\overline{\text{RESET}}$  active as long as  $V_{\text{DD}}$  or SENSE remains below the threshold voltage  $V_{\text{IT}}$ . As soon as  $V_{\text{DD}}$  (SENSE) rises above the threshold voltage  $V_{\text{IT}}$ ,  $\overline{\text{RESET}}$  is deasserted again. The product spectrum is designed for 1.5 V, 3.3 V, and adjustable supply voltages.

The devices are available in a 5-pin SC-70 package. The TPS3803 and TPS3805 devices are characterized for operation over a temperature range of  $-40^\circ\text{C}$  to  $125^\circ\text{C}$ .

### APPLICATIONS

- Applications Using DSPs, Microcontrollers, or Microprocessors
- Wireless Communication Systems
- Portable/Battery-Powered Equipment
- Programmable Controls
- Intelligent Instruments
- Industrial Equipment
- Notebook/Desktop Computers
- Automotive Systems

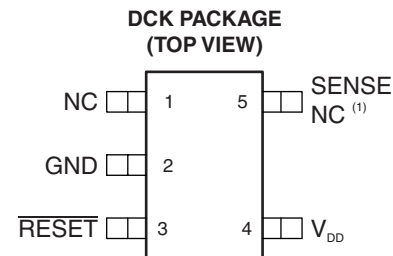

NC – No connection

(1) SENSE on TPS3803-01, TPS3805H33  
NC on TPS3803G15

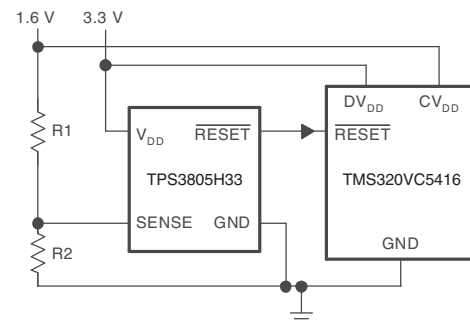

Please be aware that an important notice concerning availability, standard warranty, and use in critical applications of Texas Instruments semiconductor products and disclaimers thereto appears at the end of this data sheet.



This integrated circuit can be damaged by ESD. Texas Instruments recommends that all integrated circuits be handled with appropriate precautions. Failure to observe proper handling and installation procedures can cause damage.

ESD damage can range from subtle performance degradation to complete device failure. Precision integrated circuits may be more susceptible to damage because very small parametric changes could cause the device not to meet its published specifications.

### ORDERING INFORMATION<sup>(1)</sup>

T <sub>A</sub>	THRESHOLD VOLTAGE		PACKAGE <sup>(2)</sup>		ORDERABLE PART NUMBER	TOP-SIDE MARKING
	V <sub>DD</sub>	SENSE				
–40°C to 125°C	NA	1.226 V	SC-70 – DCK	Reel of 3000	TPS3803-01QDCKRQ1	AWJ
	1.4 V	NA			TPS3803G15QDCKRQ1	AXU
	3.05 V	1.226 V			TPS3805H33QDCKRQ1	AWZ

(1) For the most current package and ordering information, see the Package Option Addendum at the end of this document, or see the TI web site at [www.ti.com](http://www.ti.com).

(2) Package drawings, thermal data, and symbolization are available at [www.ti.com/packaging](http://www.ti.com/packaging).

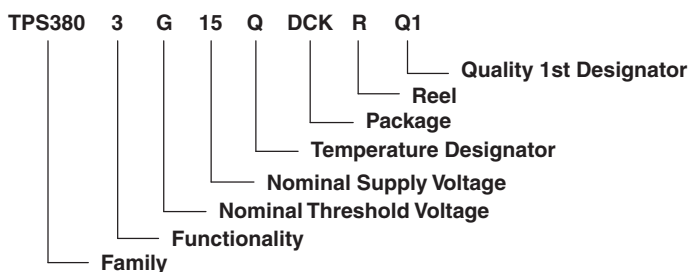

### FUNCTION/TRUTH TABLE

TPS3803-01	
SENSE > V <sub>IT</sub>	RESET
0	L
1	H

### FUNCTION/TRUTH TABLE

TPS3803G15	
V <sub>DD</sub> > V <sub>IT</sub>	RESET
0	L
1	H

### FUNCTION/TRUTH TABLE

TPS3805H33		
V <sub>DD</sub> > V <sub>IT</sub>	SENSE > V <sub>IT</sub>	RESET
0	0	L
0	1	L
1	0	L
1	1	H

**FUNCTIONAL BLOCK DIAGRAM**

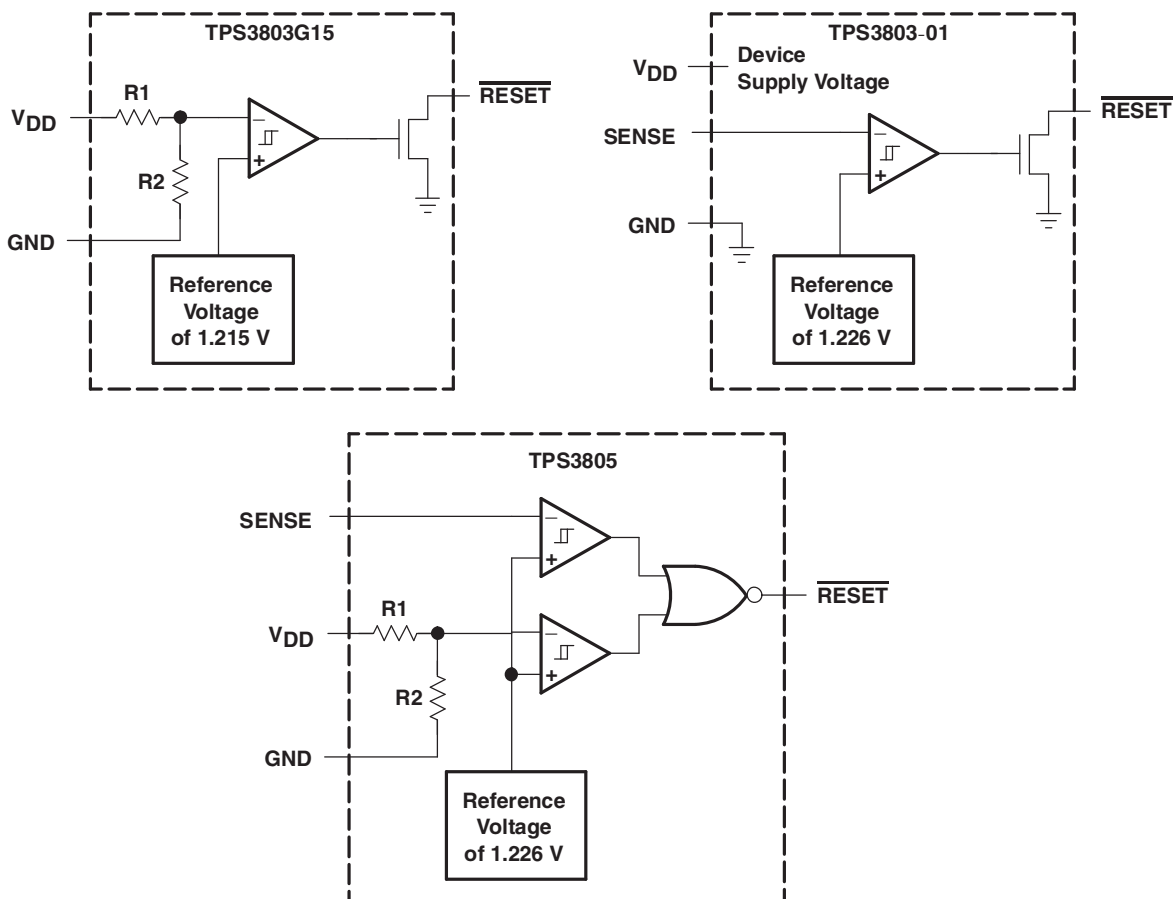

### TIMING REQUIREMENTS

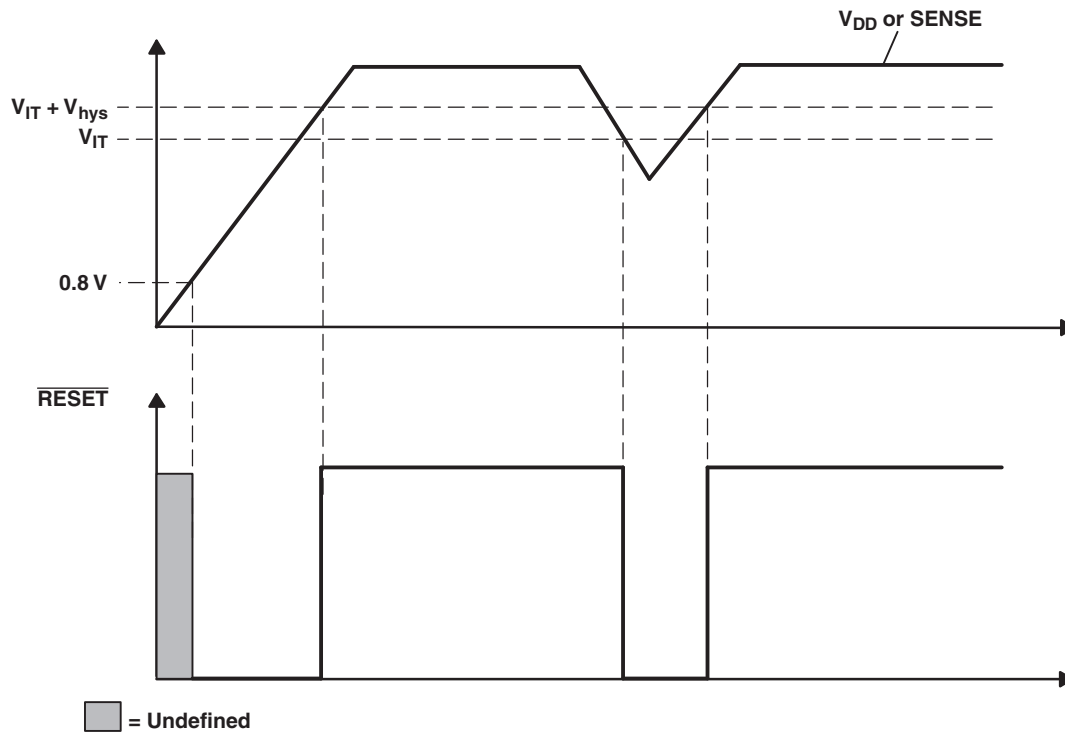

### TERMINAL FUNCTIONS

TERMINAL		I/O	DESCRIPTION
NAME	NO.		
GND	2	I	Ground
$\overline{\text{RESET}}$	3	O	Active-low reset output (TPS3803: open drain, TPS3805: push/pull)
SENSE	5	I	Adjustable sense input
NC	1		No internal connection
NC (TPS3803G15)	5		No internal connection
$V_{DD}$	4	I	Input supply voltage, fixed sense input for TPS3803G15 and TPS3805

## ABSOLUTE MAXIMUM RATINGS<sup>(1)</sup>

over operating free-air temperature range (unless otherwise noted)

		VALUE	
$V_{DD}$	Supply voltage <sup>(2)</sup>	7 V	
	Voltage applied to all other pins <sup>(2)</sup>	–0.3 V to 7 V	
$I_{OL}$	Maximum low-level output current	5 mA	
$I_{OH}$	Maximum high-level output current	–5 mA	
$I_{IK}$	Input clamp current	$V_I < 0$ or $V_I > V_{DD}$	±10 mA
$I_{OK}$	Output clamp current	$V_O < 0$ or $V_O > V_{DD}$	±10 mA
$P_D$	Continuous total power dissipation	See Dissipation Rating Table	
$T_A$	Operating free-air temperature range	–40°C to 125°C	
$T_{stg}$	Storage temperature range	–65°C to 150°C	
$T_{solder}$	Soldering temperature	260°C	

- (1) Stresses beyond those listed under *absolute maximum ratings* may cause permanent damage to the device. These are stress ratings only, and functional operation of the device at these or any other conditions beyond those indicated under *recommended operating conditions* is not implied. Exposure to absolute-maximum-rated conditions for extended periods may affect device reliability.
- (2) All voltage values are with respect to GND. For reliable operation, the device should not be continuously operated at 7 V for more than  $t = 1000$  h.

## DISSIPATION RATINGS

PACKAGE	POWER RATING $T_A < 25^\circ\text{C}$	DERATING FACTOR ABOVE $T_A = 25^\circ\text{C}$	POWER RATING $T_A = 70^\circ\text{C}$	POWER RATING $T_A = 85^\circ\text{C}$
DCK	321 mW	2.6 mW/°C	206 mW	167 mW

## RECOMMENDED OPERATING CONDITIONS

		MIN	MAX	UNIT
$V_{DD}$	Supply voltage	1.3	6	V
$V_I$	Input voltage	0	$V_{DD} + 0.3$	V
$T_A$	Operating free-air temperature	–40	125	°C

## ELECTRICAL CHARACTERISTICS

over operating free-air temperature range (unless otherwise noted)

PARAMETER		TEST CONDITIONS	MIN	TYP	MAX	UNIT	
V <sub>OH</sub>	High-level output voltage (TPS3805 only)	V <sub>DD</sub> = 1.5 V, I <sub>OH</sub> = –0.5 mA	0.8 × V <sub>DD</sub>			V	
		V <sub>DD</sub> = 3.3 V, I <sub>OH</sub> = –1 mA					
		V <sub>DD</sub> = 6 V, I <sub>OH</sub> = –1.5 mA					
V <sub>OL</sub>	Low-level output voltage	V <sub>DD</sub> = 1.5 V, I <sub>OL</sub> = 1 mA			0.3	V	
		V <sub>DD</sub> = 3.3 V, I <sub>OL</sub> = 2 mA					
		V <sub>DD</sub> = 6 V, I <sub>OL</sub> = 3 mA					
Power-up reset voltage <sup>(1)</sup>		V <sub>IT</sub> > 1.5 V, T <sub>A</sub> = 25°C	0.8			V	
		V <sub>IT</sub> ≤ 1.5 V, T <sub>A</sub> = 25°C	1				
V <sub>IT</sub>	Negative-going input threshold voltage <sup>(2)</sup>	SENSE	1.2	1.226	1.244	V	
		TPS3803G15	1.379	1.4	1.421		
		TPS3805H33	3.004	3.05	3.096		
V <sub>hys</sub>	Hysteresis	1.2 V < V <sub>IT</sub> < 2.5 V	15		mV		
		2.5 V < V <sub>IT</sub> < 3.5 V	30				
I <sub>I</sub>	Input current	SENSE	–25		25	nA	
I <sub>OH</sub>	High-level output current at RESET	Open drain only	V <sub>DD</sub> = V <sub>IT</sub> + 0.2 V, V <sub>OH</sub> = V <sub>DD</sub>		300	nA	
I <sub>DD</sub>	Supply current	TPS3803-01	V <sub>DD</sub> = 3.3 V, Output unconnected		2	4	μA
		TPS3805, TPS3803G15			3	5	
		TPS3803-01	V <sub>DD</sub> = 6 V, Output unconnected		2	4	
		TPS3805, TPS3803G15			4	6	
C <sub>I</sub>	Input capacitance	V <sub>I</sub> = 0 V to V <sub>DD</sub>	1		pF		

(1) The lowest supply voltage at which RESET (V<sub>OL(max)</sub> = 0.2 V, I<sub>OL</sub> = 50 μA) becomes active. t<sub>r</sub>(V<sub>DD</sub>) ≥ 15 μs/V.

(2) To ensure the best stability of the threshold voltage, place a bypass capacitor (ceramic, 0.1 μF) near the supply terminals.

## TIMING REQUIREMENTS

R<sub>L</sub> = 1 MΩ, C<sub>L</sub> = 50 pF, T<sub>A</sub> = –40°C to 125°C (unless otherwise noted)

PARAMETER		TEST CONDITIONS	MIN	MAX	UNIT
t <sub>w</sub>	Pulse duration	V <sub>DD</sub>	5.5		μs
		SENSE			
		V <sub>IH</sub> = 1.05 × V <sub>IT</sub> , V <sub>IL</sub> = 0.95 × V <sub>IT</sub>			

## SWITCHING CHARACTERISTICS

R<sub>L</sub> = 1 MΩ, C<sub>L</sub> = 50 pF, T<sub>A</sub> = –40°C to 125°C (unless otherwise noted)

PARAMETER		TEST CONDITIONS	MIN	TYP	MAX	UNIT
t <sub>PHL</sub>	Propagation (delay) time, high-to-low-level output	V <sub>DD</sub> to RESET delay	5	100		μs
		SENSE to RESET delay				
t <sub>PLH</sub>	Propagation (delay) time, low-to-high-level output	V <sub>DD</sub> to RESET delay	5	100		μs
		SENSE to RESET delay				
		V <sub>IH</sub> = 1.05 × V <sub>IT</sub> , V <sub>IL</sub> = 0.95 × V <sub>IT</sub>				

**TYPICAL CHARACTERISTICS**

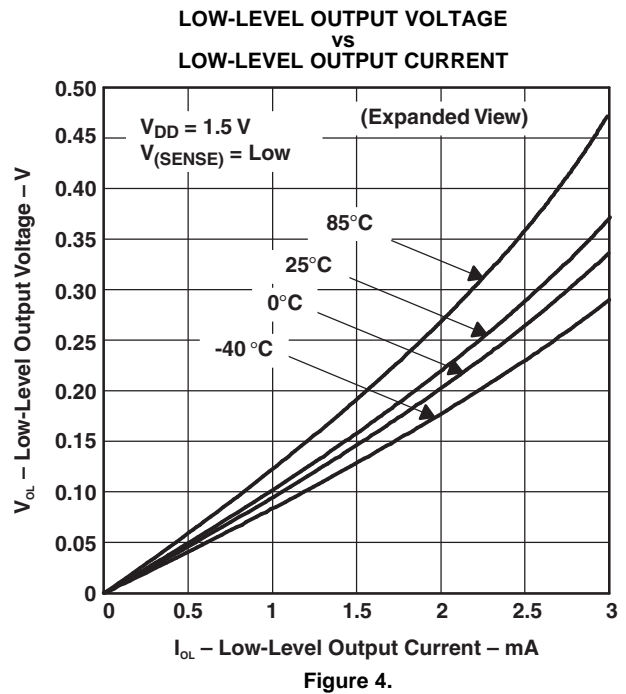
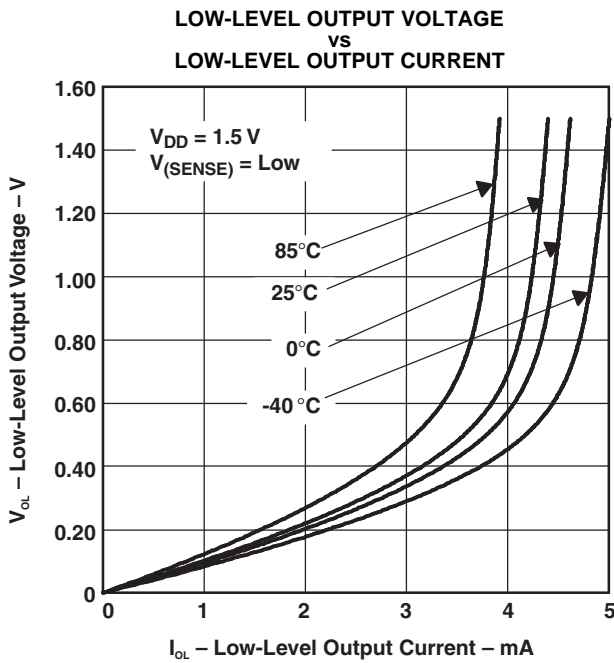
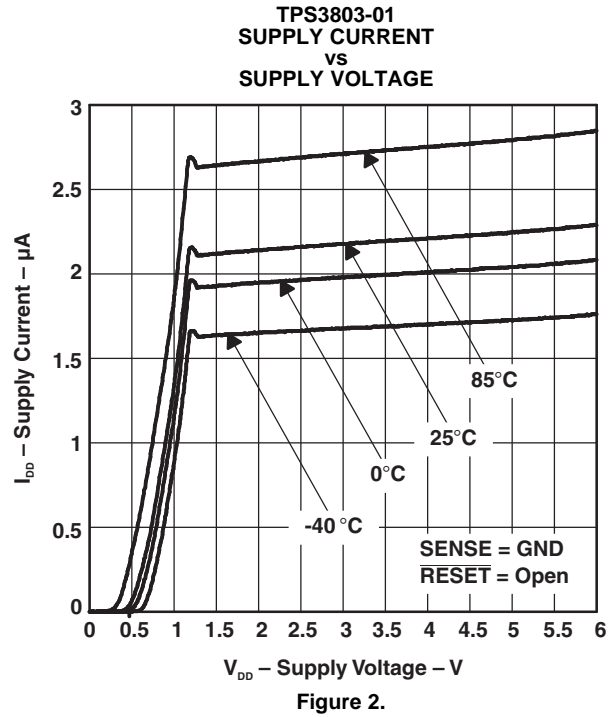
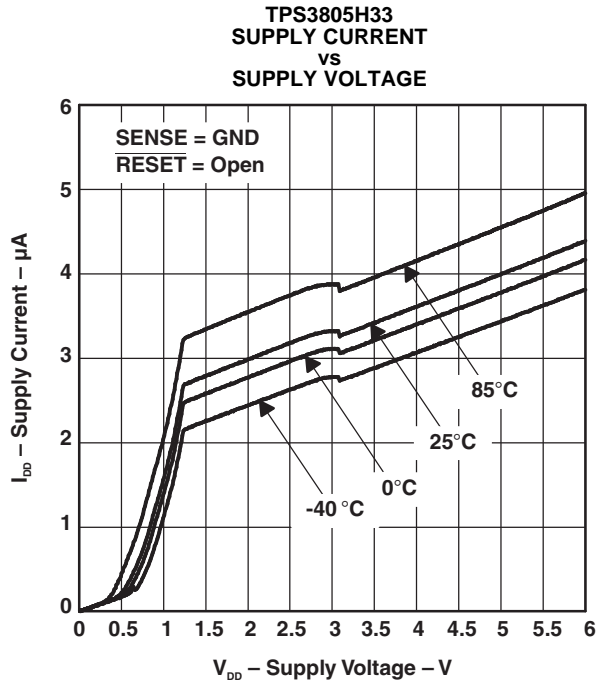

TYPICAL CHARACTERISTICS (continued)

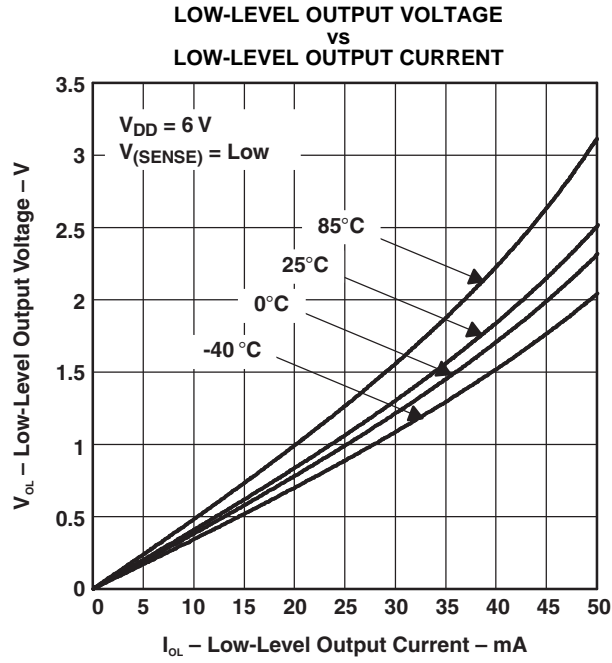

Figure 5.

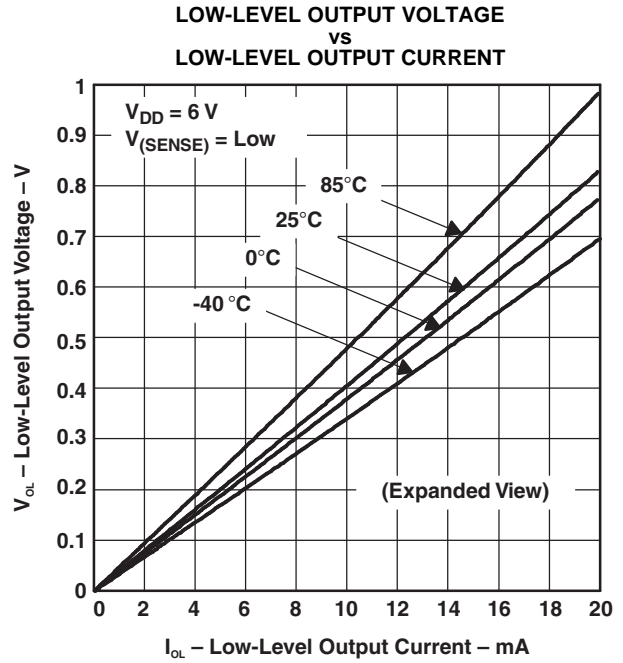

Figure 6.

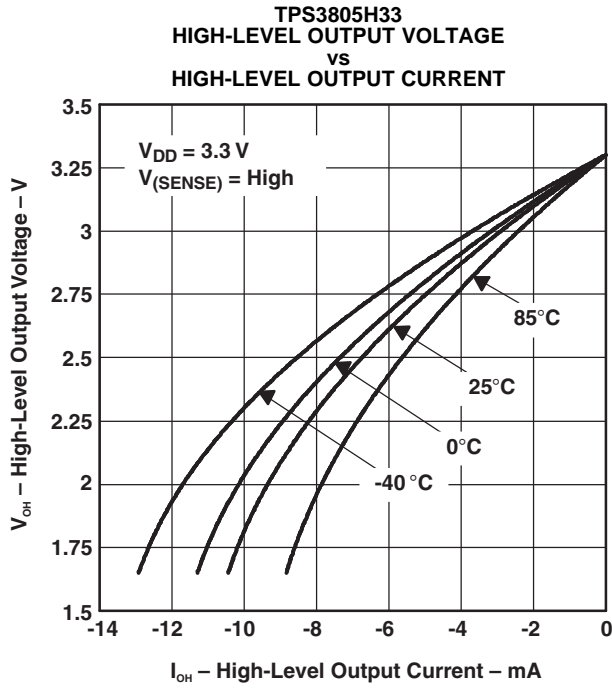

Figure 7.

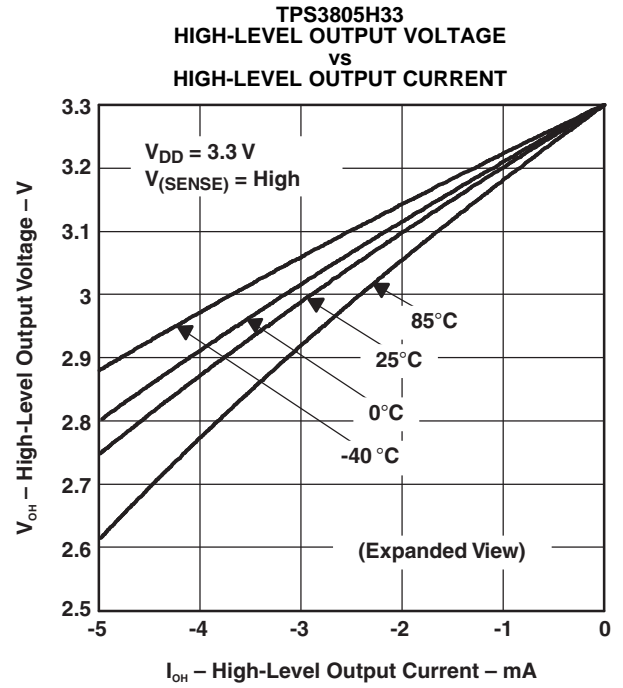

Figure 8.



TYPICAL CHARACTERISTICS (continued)

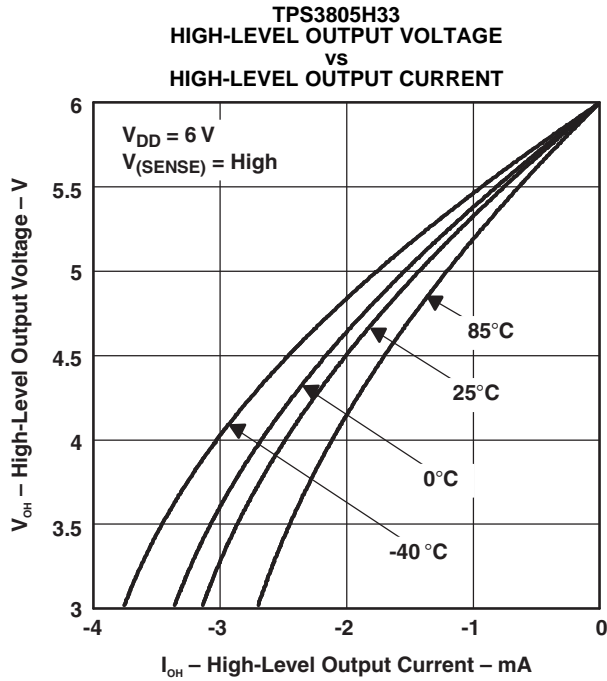

Figure 9.

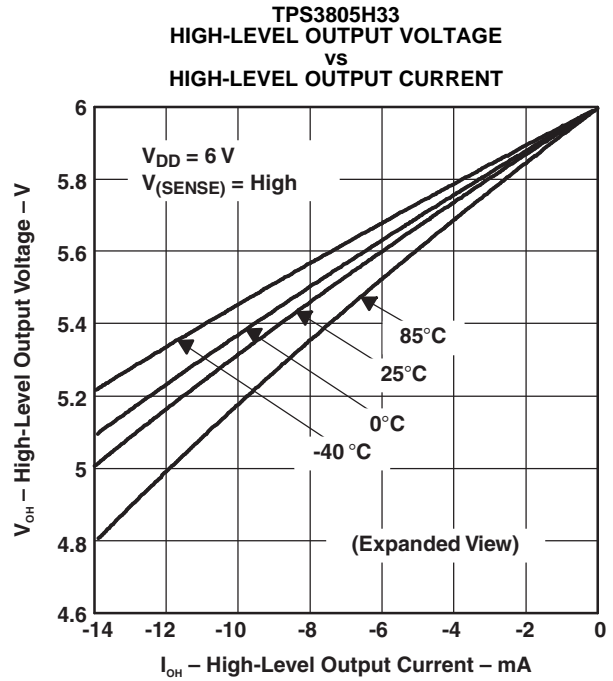

Figure 10.

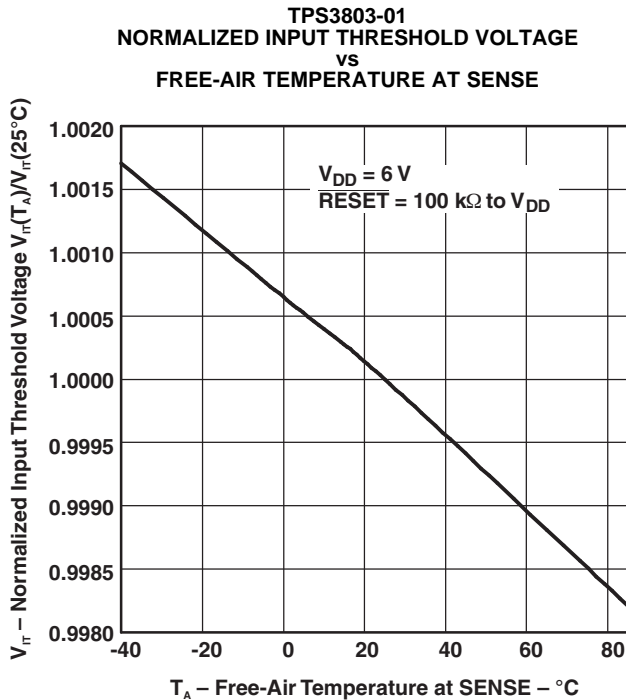

Figure 11.

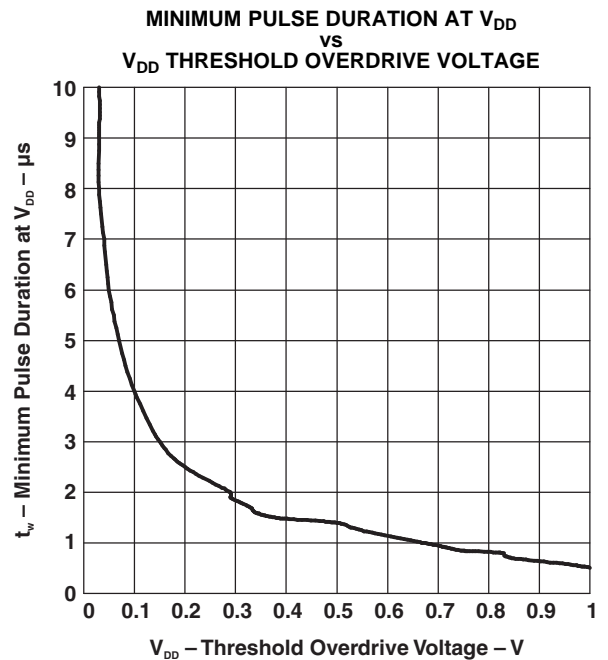

Figure 12.

### TYPICAL CHARACTERISTICS (continued)

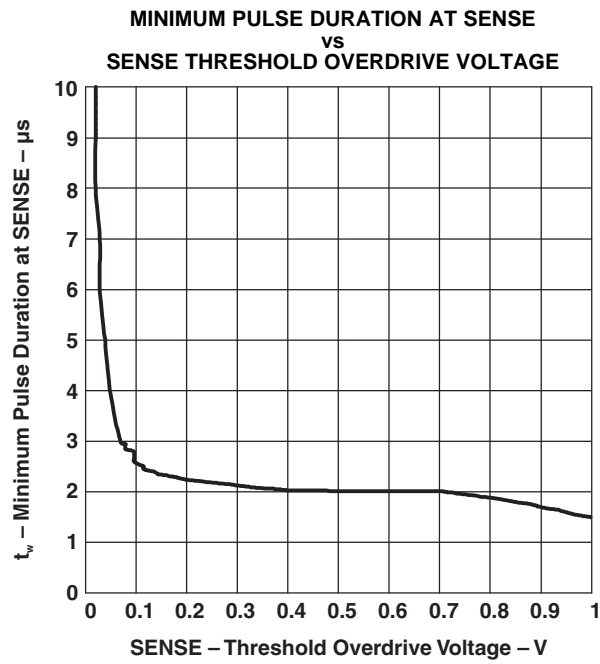

Figure 13.

### Revision History

REVISION	PAGE <sup>(1)</sup>	DESCRIPTION
SGLS228		Initial release
SGLS228A	1	Update features and description
	3	Update functional block diagram
SGLS228B	1	Update features

(1) Page numbers for previous revisions may differ from page numbers in the current version.

**PACKAGING INFORMATION**

Orderable Device	Status <sup>(1)</sup>	Package Type	Package Drawing	Pins	Package Qty	Eco Plan <sup>(2)</sup>	Lead/ Ball Finish	MSL Peak Temp <sup>(3)</sup>	Samples (Requires Login)
2T03-01QDCKRG4Q1	ACTIVE	SC70	DCK	5	3000	Green (RoHS & no Sb/Br)	CU NIPDAU	Level-1-260C-UNLIM	
2T03G15QDCKRG4Q	ACTIVE	SC70	DCK	5	3000	Green (RoHS & no Sb/Br)	CU NIPDAU	Level-1-260C-UNLIM	
2T05H33QDCKRG4Q	ACTIVE	SC70	DCK	5	3000	Green (RoHS & no Sb/Br)	CU NIPDAU	Level-1-260C-UNLIM	
TPS3803-01QDCKRQ1	ACTIVE	SC70	DCK	5	3000	Green (RoHS & no Sb/Br)	CU NIPDAU	Level-1-260C-UNLIM	
TPS3803G15QDCKRQ1	ACTIVE	SC70	DCK	5	3000	Green (RoHS & no Sb/Br)	CU NIPDAU	Level-1-260C-UNLIM	
TPS3805H33QDCKRQ1	ACTIVE	SC70	DCK	5	3000	Green (RoHS & no Sb/Br)	CU NIPDAU	Level-1-260C-UNLIM	

<sup>(1)</sup> The marketing status values are defined as follows:

**ACTIVE:** Product device recommended for new designs.

**LIFEBUY:** TI has announced that the device will be discontinued, and a lifetime-buy period is in effect.

**NRND:** Not recommended for new designs. Device is in production to support existing customers, but TI does not recommend using this part in a new design.

**PREVIEW:** Device has been announced but is not in production. Samples may or may not be available.

**OBSELETE:** TI has discontinued the production of the device.

<sup>(2)</sup> Eco Plan - The planned eco-friendly classification: Pb-Free (RoHS), Pb-Free (RoHS Exempt), or Green (RoHS & no Sb/Br) - please check <http://www.ti.com/productcontent> for the latest availability information and additional product content details.

**TBD:** The Pb-Free/Green conversion plan has not been defined.

**Pb-Free (RoHS):** TI's terms "Lead-Free" or "Pb-Free" mean semiconductor products that are compatible with the current RoHS requirements for all 6 substances, including the requirement that lead not exceed 0.1% by weight in homogeneous materials. Where designed to be soldered at high temperatures, TI Pb-Free products are suitable for use in specified lead-free processes.

**Pb-Free (RoHS Exempt):** This component has a RoHS exemption for either 1) lead-based flip-chip solder bumps used between the die and package, or 2) lead-based die adhesive used between the die and leadframe. The component is otherwise considered Pb-Free (RoHS compatible) as defined above.

**Green (RoHS & no Sb/Br):** TI defines "Green" to mean Pb-Free (RoHS compatible), and free of Bromine (Br) and Antimony (Sb) based flame retardants (Br or Sb do not exceed 0.1% by weight in homogeneous material)

<sup>(3)</sup> MSL, Peak Temp. -- The Moisture Sensitivity Level rating according to the JEDEC industry standard classifications, and peak solder temperature.

**Important Information and Disclaimer:** The information provided on this page represents TI's knowledge and belief as of the date that it is provided. TI bases its knowledge and belief on information provided by third parties, and makes no representation or warranty as to the accuracy of such information. Efforts are underway to better integrate information from third parties. TI has taken and continues to take reasonable steps to provide representative and accurate information but may not have conducted destructive testing or chemical analysis on incoming materials and chemicals. TI and TI suppliers consider certain information to be proprietary, and thus CAS numbers and other limited information may not be available for release.

In no event shall TI's liability arising out of such information exceed the total purchase price of the TI part(s) at issue in this document sold by TI to Customer on an annual basis.

**OTHER QUALIFIED VERSIONS OF TPS3803-01-Q1, TPS3803G15-Q1, TPS3805H33-Q1 :**

- Catalog: [TPS3803-01](#), [TPS3803G15](#), [TPS3805H33](#)
- Enhanced Product: [TPS3803-01-EP](#), [TPS3803G15-EP](#), [TPS3805H33-EP](#)

NOTE: Qualified Version Definitions:

- Catalog - TI's standard catalog product
- Enhanced Product - Supports Defense, Aerospace and Medical Applications

DCK (R-PDSO-G5)

PLASTIC SMALL-OUTLINE PACKAGE



- NOTES:
- A. All linear dimensions are in millimeters.
  - B. This drawing is subject to change without notice.
  - C. Body dimensions do not include mold flash or protrusion. Mold flash and protrusion shall not exceed 0.15 per side.
  - D. Falls within JEDEC MO-203 variation AA.

DCK (R-PDSO-G5)

PLASTIC SMALL OUTLINE



- NOTES:
- All linear dimensions are in millimeters.
  - This drawing is subject to change without notice.
  - Customers should place a note on the circuit board fabrication drawing not to alter the center solder mask defined pad.
  - Publication IPC-7351 is recommended for alternate designs.
  - Laser cutting apertures with trapezoidal walls and also rounding corners will offer better paste release. Customers should contact their board assembly site for stencil design recommendations. Example stencil design based on a 50% volumetric metal load solder paste. Refer to IPC-7525 for other stencil recommendations.

## IMPORTANT NOTICE

Texas Instruments Incorporated and its subsidiaries (TI) reserve the right to make corrections, modifications, enhancements, improvements, and other changes to its products and services at any time and to discontinue any product or service without notice. Customers should obtain the latest relevant information before placing orders and should verify that such information is current and complete. All products are sold subject to TI's terms and conditions of sale supplied at the time of order acknowledgment.

TI warrants performance of its hardware products to the specifications applicable at the time of sale in accordance with TI's standard warranty. Testing and other quality control techniques are used to the extent TI deems necessary to support this warranty. Except where mandated by government requirements, testing of all parameters of each product is not necessarily performed.

TI assumes no liability for applications assistance or customer product design. Customers are responsible for their products and applications using TI components. To minimize the risks associated with customer products and applications, customers should provide adequate design and operating safeguards.

TI does not warrant or represent that any license, either express or implied, is granted under any TI patent right, copyright, mask work right, or other TI intellectual property right relating to any combination, machine, or process in which TI products or services are used. Information published by TI regarding third-party products or services does not constitute a license from TI to use such products or services or a warranty or endorsement thereof. Use of such information may require a license from a third party under the patents or other intellectual property of the third party, or a license from TI under the patents or other intellectual property of TI.

Reproduction of TI information in TI data books or data sheets is permissible only if reproduction is without alteration and is accompanied by all associated warranties, conditions, limitations, and notices. Reproduction of this information with alteration is an unfair and deceptive business practice. TI is not responsible or liable for such altered documentation. Information of third parties may be subject to additional restrictions.

Resale of TI products or services with statements different from or beyond the parameters stated by TI for that product or service voids all express and any implied warranties for the associated TI product or service and is an unfair and deceptive business practice. TI is not responsible or liable for any such statements.

TI products are not authorized for use in safety-critical applications (such as life support) where a failure of the TI product would reasonably be expected to cause severe personal injury or death, unless officers of the parties have executed an agreement specifically governing such use. Buyers represent that they have all necessary expertise in the safety and regulatory ramifications of their applications, and acknowledge and agree that they are solely responsible for all legal, regulatory and safety-related requirements concerning their products and any use of TI products in such safety-critical applications, notwithstanding any applications-related information or support that may be provided by TI. Further, Buyers must fully indemnify TI and its representatives against any damages arising out of the use of TI products in such safety-critical applications.

TI products are neither designed nor intended for use in military/aerospace applications or environments unless the TI products are specifically designated by TI as military-grade or "enhanced plastic." Only products designated by TI as military-grade meet military specifications. Buyers acknowledge and agree that any such use of TI products which TI has not designated as military-grade is solely at the Buyer's risk, and that they are solely responsible for compliance with all legal and regulatory requirements in connection with such use.

TI products are neither designed nor intended for use in automotive applications or environments unless the specific TI products are designated by TI as compliant with ISO/TS 16949 requirements. Buyers acknowledge and agree that, if they use any non-designated products in automotive applications, TI will not be responsible for any failure to meet such requirements.

Following are URLs where you can obtain information on other Texas Instruments products and application solutions:

### Products

Audio	<a href="http://www.ti.com/audio">www.ti.com/audio</a>
Amplifiers	<a href="http://amplifier.ti.com">amplifier.ti.com</a>
Data Converters	<a href="http://dataconverter.ti.com">dataconverter.ti.com</a>
DLP® Products	<a href="http://www.dlp.com">www.dlp.com</a>
DSP	<a href="http://dsp.ti.com">dsp.ti.com</a>
Clocks and Timers	<a href="http://www.ti.com/clocks">www.ti.com/clocks</a>
Interface	<a href="http://interface.ti.com">interface.ti.com</a>
Logic	<a href="http://logic.ti.com">logic.ti.com</a>
Power Mgmt	<a href="http://power.ti.com">power.ti.com</a>
Microcontrollers	<a href="http://microcontroller.ti.com">microcontroller.ti.com</a>
RFID	<a href="http://www.ti-rfid.com">www.ti-rfid.com</a>
OMAP Mobile Processors	<a href="http://www.ti.com/omap">www.ti.com/omap</a>
Wireless Connectivity	<a href="http://www.ti.com/wirelessconnectivity">www.ti.com/wirelessconnectivity</a>

### Applications

Automotive and Transportation	<a href="http://www.ti.com/automotive">www.ti.com/automotive</a>
Communications and Telecom	<a href="http://www.ti.com/communications">www.ti.com/communications</a>
Computers and Peripherals	<a href="http://www.ti.com/computers">www.ti.com/computers</a>
Consumer Electronics	<a href="http://www.ti.com/consumer-apps">www.ti.com/consumer-apps</a>
Energy and Lighting	<a href="http://www.ti.com/energy">www.ti.com/energy</a>
Industrial	<a href="http://www.ti.com/industrial">www.ti.com/industrial</a>
Medical	<a href="http://www.ti.com/medical">www.ti.com/medical</a>
Security	<a href="http://www.ti.com/security">www.ti.com/security</a>
Space, Avionics and Defense	<a href="http://www.ti.com/space-avionics-defense">www.ti.com/space-avionics-defense</a>
Video and Imaging	<a href="http://www.ti.com/video">www.ti.com/video</a>

TI E2E Community Home Page

[e2e.ti.com](http://e2e.ti.com)

Mailing Address: Texas Instruments, Post Office Box 655303, Dallas, Texas 75265  
Copyright © 2012, Texas Instruments Incorporated