

DUAL SYNCHRONOUS STEP-DOWN CONTROLLER FOR LOW VOLTAGE POWER RAILS

Check for Samples: [TPS53128](#)

FEATURES

- **D-CAP2™ Mode Control**
 - Fast Transient Response
 - No External Parts Required for Loop Compensation
 - Compatible With Ceramic Output Capacitors
- High Initial Reference Accuracy ($\pm 1\%$)
- Low Output Ripple
- Wide Input Voltage Range: 4.5 V to 24 V
- Output Voltage Range: 0.76 V to 5.5 V
- Low-Side $R_{DS(ON)}$ Loss-Less Current Sensing
- Adaptive Gate Drivers with Integrated Boost Diode
- Adjustable Soft Start
- Non-Sinking Pre-Biased Soft Start

- 350-kHz Switching Frequency
- Cycle-by-Cycle Over-Current Limiting Control
- 30-mV to 300-mV OCP Threshold Voltage
- Thermally Compensated OCP by 4000 ppm/°C at I_{TRIP}

APPLICATIONS

- Point-of-Load Regulation in Low Power Systems for Wide Range of Applications
 - Digital TV Power Supply
 - Networking Home Terminal
 - Digital Set-Top Box (STB)
 - DVD Player/Recorder
 - Gaming Consoles

DESCRIPTION

The TPS53128 is a dual, adaptive on-time D-CAP2™ mode synchronous buck controller. The part enables system designers to cost effectively complete the suite of various end equipment's power bus regulators with a low external component count and low standby consumption. The main control loop for the TPS53128 uses the D-CAP2™ Mode topology which provides a very fast transient response with no external component.

The TPS53128 also has a proprietary circuit that enables the device to adapt not only low equivalent series resistance (ESR) output capacitors such as POSCAP/SP-CAP, but also ceramic capacitor. The fixed frequency emulated adaptive on-time control supports seamless operation between PWM mode at heavy load condition and reduced frequency operation at light load for high efficiency down to milliampere range. The part provides a convenient and efficient operation with conversion voltages from 4.5 V to 24 V and output voltage from 0.76 V to 5.5 V.

The TPS53128 is available in 4-mm x 4-mm 24 pin QFN (RGE) or 24 pin TSSOP (PW) packages, and is specified from -40°C to 85°C ambient temperature range.



Please be aware that an important notice concerning availability, standard warranty, and use in critical applications of Texas Instruments semiconductor products and disclaimers thereto appears at the end of this data sheet.

D-CAP2 is a trademark of Texas Instruments.

TYPICAL APPLICATION CIRCUITS

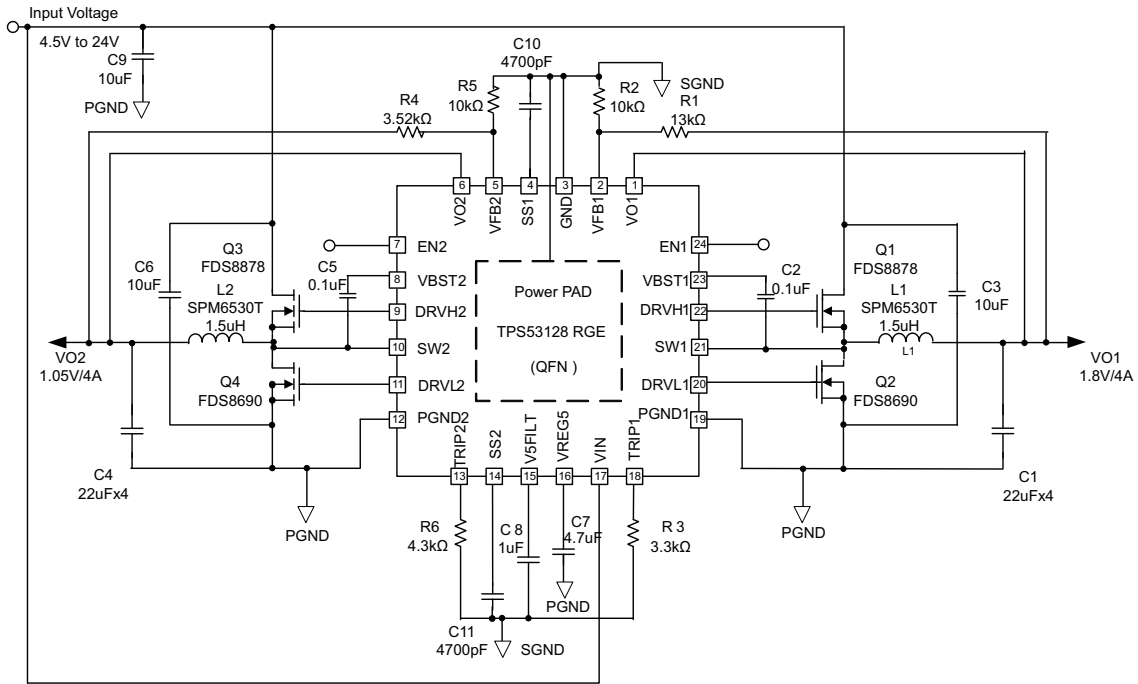

Figure 1. QFN

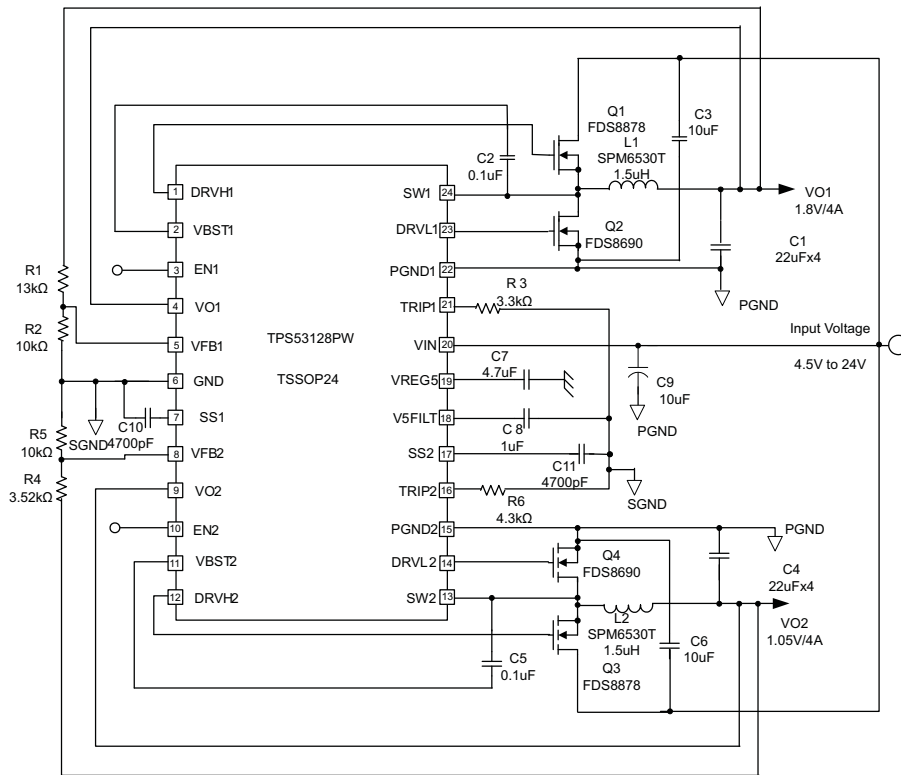

Figure 2. TSSOP

ORDERING INFORMATION⁽¹⁾

T _A	PACKAGE ^{(2) (3)}	ORDERING PART NUMBER	PINS	OUTPUT SUPPLY	ECO PLAN
-40°C to 85°C	Plastic Quad Flat Pack (QFN)	TPS53128RGET	24	Tape-and-Reel	Green (RoHS and no Sb/Br)
		TPS53128RGER		Tape-and-Reel	
	TSSOP	TPS53128PWR		Tape-and-Reel	
		TPS53128PW		Tube	

- (1) For the most current package and ordering information, see the Package Option Addendum at the end of this document, or see the TI web site at www.ti.com.
- (2) Package drawings, thermal data, and symbolization are available at www.ti.com/packaging.
- (3) All packaging options have Cu NIPDAU lead/ball finish.

ABSOLUTE MAXIMUM RATINGS

 over operating free-air temperature range (unless otherwise noted) ⁽¹⁾

		VALUE	UNIT
V _I	Input voltage range	VIN, EN1, EN2	V
		VBST1, VBST2	
		VBST1 - SW1, VBST2 - SW2	
		V5FILT, VFB1, VFB2, TRIP1, TRIP2, VO1, VO2	
		SW1, SW2	
V _O	Output voltage range	DRVH1, DRVH2	V
		DRVH1 - SW1, DRVH2 - SW2	
		DRVL1, DRVL2, VREG5, SS1, SS2	
		PGND1, PGND2	
T _A	Operating ambient temperature range	-40 to 85	°C
T _{STG}	Storage temperature range	-55 to 150	°C
T _J	Junction temperature range	-40 to 150	°C

- (1) Stresses beyond those listed under "absolute maximum ratings" may cause permanent damage to the device. These are stress ratings only and functional operation of the device at these or any other conditions beyond those indicated under "recommended operating conditions" are not implied. Exposure to absolute-maximum-rated conditions for extended periods may affect device reliability.

DISSIPATION RATINGS

2-oz. trace and copper pad with solder

PACKAGE	T _A < 25°C POWER RATING	DERATING FACTOR ABOVE T _A = 25°C	T _A = 85°C POWER RATING
24-pin QFN	2.33 W	23.3 mW/°C	0.93 W
24-pin TSSOP	0.778 W	7.8 mW/°C	0.31 W

RECOMMENDED OPERATING CONDITIONS

over operating free-air temperature range (unless otherwise noted)

			MIN	MAX	UNIT
V _{IN}	Supply input voltage	VIN	4.5	24	V
		V5FILT	4.5	5.5	
V _I	Input voltage	VBST1, VBST2	-0.1	30	V
		VBST1 - SW1, VBST2 - SW2	-0.1	5.5	
		VFB1, VFB2, VO1, VO2	-0.1	5.5	
		TRIP1, TRIP2	-0.1	0.3	
		EN1, EN2	-0.1	24	
		SW1, SW2	-1.8	24	

RECOMMENDED OPERATING CONDITIONS (continued)

over operating free-air temperature range (unless otherwise noted)

		MIN	MAX	UNIT	
V _O	Output voltage	DRVH1, DRVH2	-0.1	30	V
		VBST1 - SW1, VBST2 - SW2	-0.1	5.5	
		DRVL1, DRVL2, VREG5, SS1, SS2	-0.1	5.5	
		PGND1, PGND2	-0.1	0.1	
T _A	Operating free-air temperature	-40	85	°C	
T _J	Operating junction temperature	-40	125	°C	

ELECTRICAL CHARACTERISTICS

over operating free-air temperature range (unless otherwise noted)

PARAMETER		TEST CONDITIONS	MIN	TYP	MAX	UNIT
SUPPLY CURRENT						
I _{IN}	VIN supply current	VIN current, T _A = 25°C, VREG5 tied to V5FILT, EN1 = EN2 = 5 V, VFB1 = VFB2 = 0.8 V, SW1 = SW2 = 0.5 V		450	800	μA
I _{VINSDN}	VIN shutdown current	VIN current, T _A = 25°C, no load, EN1 = EN2 = 0 V, VREG5 = ON		30	60	μA
VFB VOLTAGE AND DISCHARGE RESISTANCE						
V _{BG}	Bandgap initial regulation accuracy	T _A = 25°C	-1		1	%
V _{VFBTHX}	VFBx threshold voltage	T _A = 25°C, SW _{inj} = OFF	755	765	775	mV
		T _A = 0°C to 70°C, SW _{inj} = OFF ⁽¹⁾	753.5		776.5	
		T _A = -40°C to 85°C, SW _{inj} = OFF ⁽¹⁾	752		778	
I _{VFB}	VFB input current	VFBx = 0.8 V, T _A = 25°C	-100	-10	100	nA
R _{Dischg}	VO discharge resistance	ENx = 0 V, VOx = 0.5 V, T _A = 25°C		40	80	Ω
VREG5 OUTPUT						
V _{VREG5}	VREG5 output voltage	T _A = 25°C, 5.5 V < VIN < 24 V, 0 < I _{VREG5} < 10 mA	4.8	5.0	5.2	V
V _{LN5}	Line regulation	5.5 V < VIN < 24 V, I _{VREG5} = 10 mA			20	mV
V _{LD5}	Load regulation	1 mA < I _{VREG5} < 10 mA			40	mV
I _{VREG5}	Output current	VIN = 5.5 V, VREG5 = 4.0 V, T _A = 25°C		170		mA
OUTPUT: N-CHANNEL MOSFET GATE DRIVERS						
R _{DRVH}	DRVH resistance	Source, I _{DRVHx} = -100 mA		5.5	11	Ω
		Sink, I _{DRVHx} = 100 mA		2.5	5	
R _{DRVL}	DRVL resistance	Source, I _{DRVLx} = -100 mA		4	8	Ω
		Sink, I _{DRVLx} = 100 mA		2	4	
T _D	Dead time	DRVHx-low to DRVLx-on	20	50	80	ns
		DRVLx-low to DRVHx-on	20	40	80	
INTERNAL BOOST DIODE						
V _{FBST}	Forward voltage	V _{VREG5-VBSTx} , I _F = 10 mA, T _A = 25°C	0.7	0.8	0.9	V
I _{VBSTLK}	VBST leakage current	VBSTx = 29 V, SWx = 24 V, T _A = 25°C		0.1	1	μA
ON-TIME TIMER CONTROL						
T _{ON1L}	CH1 on time	SW1 = 12 V, VO1 = 1.8 V		490		ns
T _{ON2L}	CH2 on time	SW2 = 12 V, VO2 = 1.8 V		390		ns

(1) Not production tested - ensured by design.

ELECTRICAL CHARACTERISTICS (continued)

over operating free-air temperature range (unless otherwise noted)

PARAMETER		TEST CONDITIONS	MIN	TYP	MAX	UNIT
T _{OFF1L}	CH1 min off time	SW1 = 0.7 V, T _A = 25°C, VFB1 = 0.7 V		285		ns
T _{OFF2L}	CH2 min off time	SW2 = 0.7 V, T _A = 25°C, VFB2 = 0.7 V		285		ns
SOFT START						
I _{SSC}	SS1/SS2 charge current	V _{SS1} /V _{SS2} = 0 V, T _A = 25°C	-1.5	-2	-2.5	μA
TC _{ISSC}	I _{SSC} temperature coefficient	On the basis of 25°C ⁽¹⁾	-4		3	nA/°C
I _{SSD}	SS1/SS2 discharge current	V _{SS1} /V _{SS2} = 0.5 V	100	150		μA
UVLO						
V _{UV5VFILT}	V5FILT UVLO threshold	Wake up	3.7	4.0	4.3	V
		Hysteresis	0.2	0.3	0.4	
LOGIC THRESHOLD						
V _{ENH}	ENx high-level input voltage	EN 1/2	2.0			V
V _{ENL}	ENx low-level input voltage	EN 1/2			0.3	V
CURRENT SENSE						
I _{TRIP}	TRIP source current	V _{TRIPx} = 0.1 V, T _A = 25°C	8.5	10	11.5	μA
TC _{I_{TRIP}}	I _{TRIP} temperature coefficient	On the basis of 25°C		4000		ppm/°C
V _{OCLoff}	OCP compensation offset	(V _{TRIPx-GND} -V _{PGNDx-SWx}) voltage, V _{TRIPx-GND} = 60 mV, T _A = 25°C	-15	0	15	mV
		(V _{TRIPx-GND} -V _{PGNDx-SWx}) voltage, V _{TRIPx-GND} = 60 mV	-20		20	
V _{Rtrip}	Current limit threshold setting range	V _{TRIPx-GND} voltage	30		300	mV
OUTPUT UNDERVOLTAGE AND OVERVOLTAGE PROTECTION						
V _{OVP}	Output OVP trip threshold	OVP detect	110	115	120	%
T _{OVPDEL}	Output OVP prop delay			1.5		μs
V _{UVP}	Output UVP trip threshold	UVP detect	65	70	75	%
		Hysteresis (recover < 20 μs)		10		
T _{UVPDEL}	Output UVP delay		17	30	40	μs
T _{UVPEN}	Output UVP enable delay	UVP enable delay / soft-start time	x1.4	x1.7	x2.0	ms
THERMAL SHUTDOWN						
T _{SDN}	Thermal shutdown threshold	Shutdown temperature ⁽²⁾		150		°C
		Hysteresis ⁽²⁾		20		

(2) Not production tested - ensured by design.

TERMINAL FUNCTIONS
PIN Function Table

TERMINAL			I/O	DESCRIPTION
NAME	QFN 24	TSSOP 24		
VBST1, VBST2	23, 8	2, 11	I	Supply input for high-side NFET driver. Bypass to SWx with a high-quality 0.1-μF ceramic capacitor. An external schottky diode can be added from VREG5 if forward drop is critical to drive the high-side FET.
EN1, EN2	24, 7	3, 10	I	Enable. Pull High to enable SMPS.
VO1, VO2	1, 6	4, 9	I	Output voltage inputs for on-time adjustment and output discharge. Connect directly to the output voltage.
VFB1, VFB2	2, 5	5, 8	I	D-CAP2 feedback inputs. Connect to output voltage with resistor divider.

PIN Fucntion Table (continued)

TERMINAL			I/O	DESCRIPTION
NAME	QFN 24	TSSOP 24		
GND	3	6	I	Signal ground pin. Connect to PGND1, PGND2 and system ground at a single point.
DRVH1, DRVH2	22, 9	1, 12	O	High-side N-Channel MOSFET gate driver outputs. SWx referenced drivers switch between SWx (OFF) and VBSTx (ON).
SW1, SW2	21, 10	24, 13	I/O	Switch node connections for both the high-side drivers and the over current comparators.
DRVL1, DRVL2	20, 11	23, 14	O	Low-side N-Channel MOSFET gate driver outputs. PGND referenced drivers switch between PGNDx (OFF) and VREG5 (ON).
PGND1, PGND2	19, 12	22, 15	I/O	Power ground connections for both the low-side drivers and the over current comparators. Connect PGND1, PGND2 and GND strongly together near the IC.
TRIP1, TRIP2	18, 13	21, 16	I	Over current threshold programming pin. Connect to GND with a resistor to GND to set threshold for low-side $R_{DS(ON)}$ current limit.
VIN	17	20	I	Supply Input for 5-V linear regulator. Bypass to GND with a minimum high-quality 0.1- μ F ceramic capacitor.
V5FILT	15	18	I	5-V supply input for the entire control circuitry except the MOSFET drivers. Bypass to GND with a minimum high-quality 1.0- μ F ceramic capacitor. V5FILT is connected to VREG5 via an internal 10- Ω resistor.
VREG5	16	19	O	Output of 5-V linear regulator and supply for MOSFET drivers. Bypass to GND with a minimum high-quality 4.7- μ F ceramic capacitor. VREG5 is connected to V5FILT via an internal 10- Ω resistor.
SS1, SS2	4,14	7, 17	O	Soft-start programming pin. Connect capacitor from SSx pin to GND to program soft-start time.

QFN PACKAGE
(TOP VIEW)

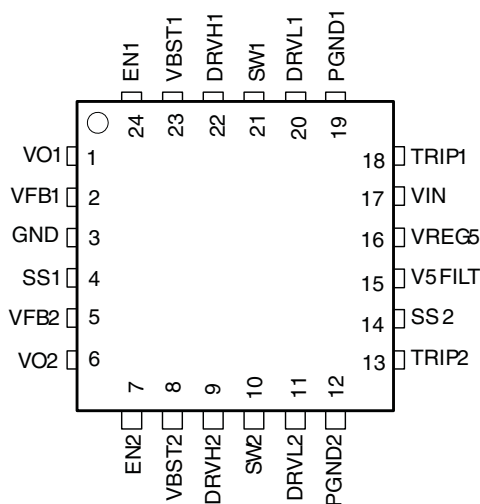

TSSOP PACKAGE
(TOP VIEW)

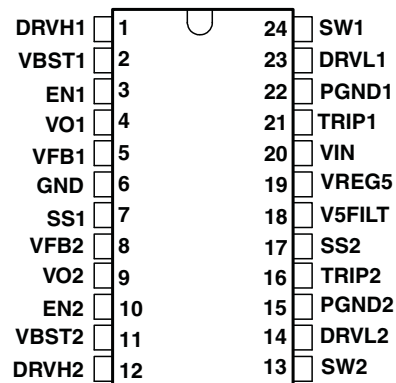

FUNCTIONAL BLOCK DIAGRAM

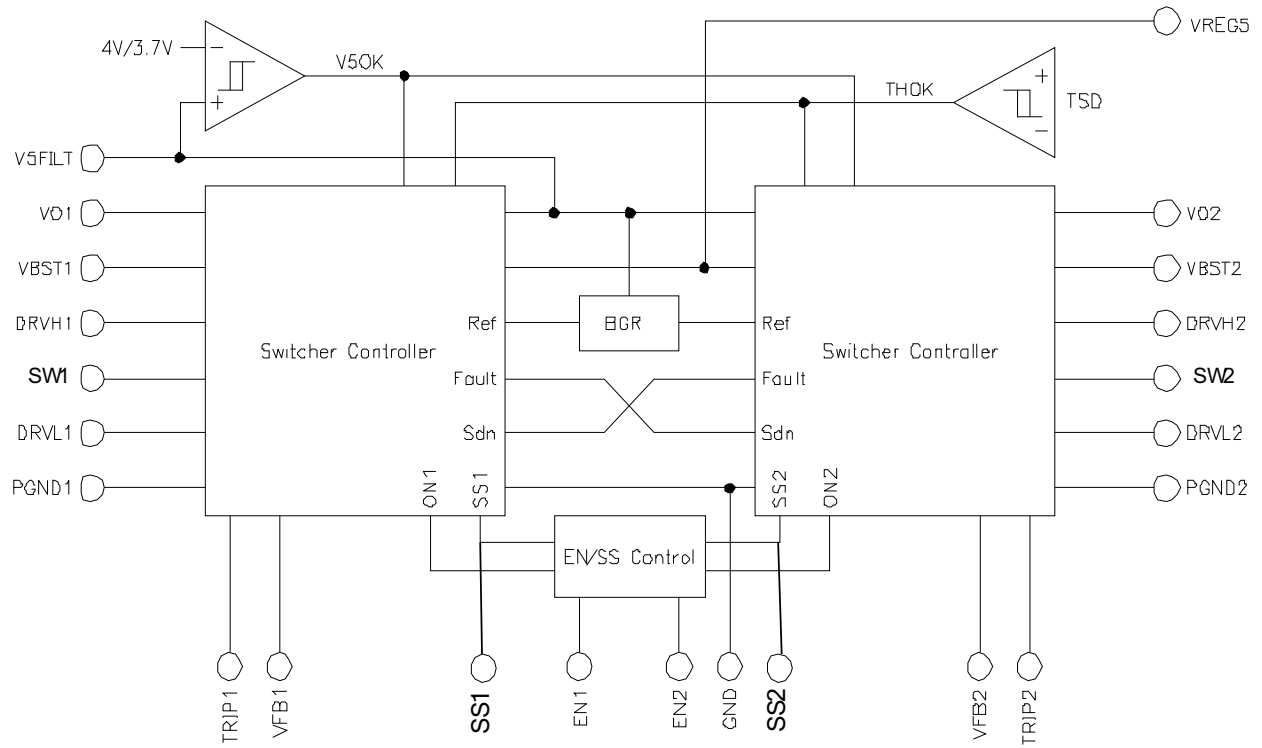

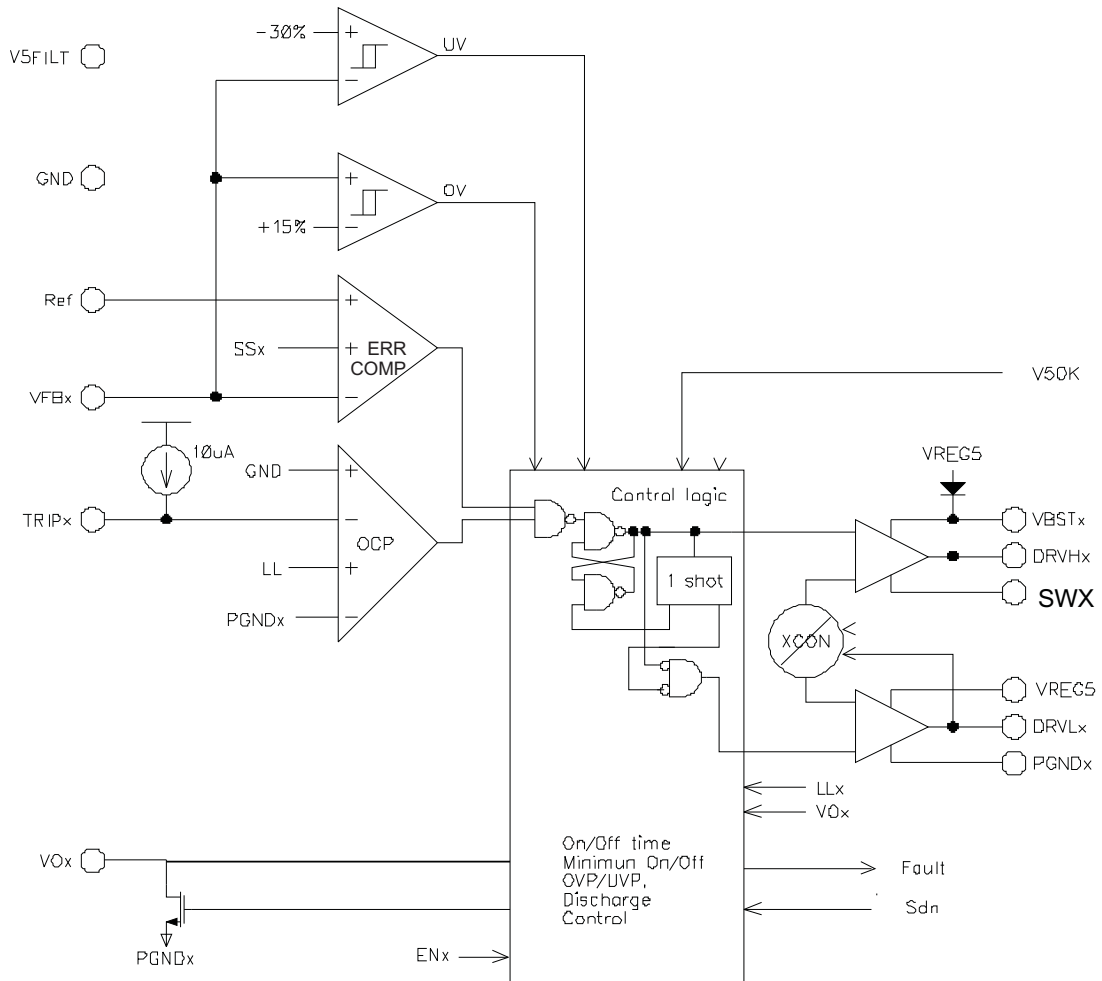

DETAILED DESCRIPTION

PWM Operation

The main control loop of the TPS53128 is an adaptive on-time pulse width modulation (PWM) controller using a proprietary D-CAP2™ mode control. D-CAP2™ mode control combines constant on-time control with an internal compensation circuit for pseudo-fixed frequency and low external component count configuration with both low ESR and ceramic output capacitors. It is stable even with virtually no ripple at the output.

At the beginning of each cycle, the synchronous high-side MOSFET is turned on. After an internal one-shot timer expires, this MOSFET is turned off. When the feedback voltage falls below the reference voltage, the one-shot timer is reset and the high-side MOSFET is turned back on. The one shot is set by the converter input voltage V_{IN} , and the output voltage V_O , to maintain a pseudo-fixed frequency over the input voltage range. An internal ramp is added to the reference voltage to simulate output ripple, eliminating the need for ESR induced output ripple from D-CAP mode control.

Light-Load Condition

TPS53128 automatically reduces switching frequency at light-load conditions to maintain high efficiency. This reduction of frequency is achieved smoothly and without increase of V_{OUT} ripple or load regulation. Detail operation is described as follows. As the output current decreases from heavy-load condition, the inductor current is also reduced, and eventually comes to the point that its valley touches zero current, which is the boundary between continuous conduction and discontinuous condition modes. The low-side MOSFET is turned off when this zero inductor current is detected. As the load current is further decreased, the converter runs in discontinuous conduction mode and it takes longer and longer to discharge the output capacitor to the level that requires the next ON cycle. The ON time is kept the same as that in the heavy-load condition. In reverse, when the output current increases from light load to heavy load, the switching frequency increases to the preset value as the inductor current reaches the continuous conduction. The transition load point to the light load operation, $I_{OUT(LL)}$ (i.e., threshold between continuous and discontinuous condition mode) can be calculated as follows.

$$I_{OUT(LL)} = \frac{1}{2 \times L \times f_{SW}} \frac{V_{IN} - V_{OX}}{V_{IN}} \times V_{OX} \quad (1)$$

Where f_{SW} is the PWM switching frequency.

Switching frequency versus output current in the light-load condition is a function of L , f_{SW} , V_{IN} and V_{OUT} , but it decreases almost proportional to the output current from the $I_{OUT(LL)}$ given in [Equation 1](#).

Drivers

Each channel of the TPS53128 contains two high-current resistive MOSFET gate drivers. The low-side driver is a PGND referenced, VREG5 powered driver designed to drive the gate of a high-current, low $R_{DS(ON)}$ N-channel MOSFET whose source is connected to PGND. The high-side driver is a floating SWx referenced VBST powered driver designed to drive the gate of a high-current, low $R_{DS(ON)}$ N-channel MOSFET. To maintain the VBST voltage during the high-side driver ON time, a capacitor is placed from SWx to VBSTx. Each driver draws average current equal to gate charge (Q_g at $V_{gs} = 5\text{ V}$) times switching frequency (f_{SW}).

To prevent cross-conduction, there is a narrow dead-time when both high-side and low-side drivers are OFF between each driver transition. During this time the inductor current is carried by one of the MOSFETs body diodes.

PWM Frequency and Adaptive On-Time Control

TPS53128 employs adaptive on-time control scheme and does not have a dedicated on board oscillator.

TPS53128 runs with pseudo-constant frequency by using the input voltage and output voltage to set the on-time one-shot timer. The on-time is inversely proportional to the input voltage and proportional to the output voltage. Therefore, when the duty ratio is V_{OUT}/V_{IN} , the frequency is constant.

5-Volt Regulator

The TPS53128 has an internal 5-V low-dropout (LDO) regulator to provide a regulated voltage for all both drivers and the IC's internal logic. A high-quality 4.7- μ F or greater ceramic capacitor from VREG5 to GND is required to stabilize the internal regulator. An internal 10- Ω resistor from VREG5 filters the regulator output to the IC's analog and logic input voltage, V5FILT. An additional high-quality 1.0- μ F ceramic capacitor is required from V5FILT to GND to filter switching noise from VREG5.

Soft Start

The TPS53128 has a programmable soft-start. When the ENx pin becomes high, 2.0- μ A current begins charging the capacitor connected from the SS pin to GND. The internal reference for the D-CAP2™ mode control comparator is overridden by the soft-start voltage until the soft-start voltage is greater than the internal reference for smooth control of the output voltage during start up.

Pre-Bias Support

The TPS53128 supports pre-bias start-up without sinking current from the output capacitor. When enabled, the low-side driver is held off until the soft-start commands a voltage higher than the pre-bias level (internal soft-start becomes greater than feedback voltage (VFB)), then the TPS53128 slowly activates synchronous rectification by limiting the first DRV1 pulses with a narrow on-time. This limited on-time is then incremented on a cycle-by-cycle basis until it coincides with the full 1-D off-time. This scheme prevents the initial sinking of current from the pre-bias output, and ensure that the output voltage (VOUT) starts and ramps up smoothly into regulation and the control loop is given time to transition from pre-biased start-up to normal mode operation.

Output Discharge Control

TPS53128 discharges the outputs when ENx is low, or the controller is turned off by the protection functions (OVP, UVP, UVLO, and thermal shutdown). The device discharges output using an internal 40- Ω MOSFET which is connected to VOx and PGNDx. The external low-side MOSFET is not turned on during the output discharge operation to avoid the possibility of causing negative voltage at the output. This discharge ensures that on start the regulated voltage always initializes from 0 V.

Over Current Limit

TPS53128 has cycle-by-cycle over current limit feature. The over current limits the inductor valley current by monitoring the voltage drop across the low-side MOSFET $R_{DS(ON)}$ during the low-side driver on-time. If the inductor current is larger than the over current limit (OCL), the TPS53128 delays the start of the next switching cycle until the sensed inductor current falls below the OCL current. MOSFET $R_{DS(ON)}$ current sensing is used to provide an accuracy and cost effective solution without external devices. To program the OCL, the TRIP pin should be connected to GND through a trip voltage setting resistor, according to the following equations.

$$V_{TRIP} = \left(I_{OCL} - \frac{(V_{IN} - V_O)}{2 \cdot L1 \cdot f_{SW}} \cdot \frac{V_O}{V_{IN}} \right) \cdot R_{DS(ON)} \quad (2)$$

$$R_{TRIP} (k\Omega) = \frac{V_{TRIP} (mV)}{I_{TRIP} (\mu A)} \quad (3)$$

The trip voltage should be between 30 mV to 300 mV over all operational temperature, including the 4000-ppm/°C temperature slope compensation for the temperature dependency of the $R_{DS(ON)}$.

If the load current exceeds the over current limit, the voltage will begin to drop. If the over current conditions continues the output voltage will fall below the under voltage protection threshold and the TPS53128 will shut down.

In an over current condition, the current to the load exceeds the current to the output capacitor; thus the output voltage tends to fall off. Eventually, it will end up with crossing the under voltage protection threshold and shutdown.

Over/Under Voltage Protection

TPS53128 monitors a resistor divided feedback voltage to detect over and under voltage. If the feedback voltage is higher than 115% of the reference voltage, the OVP comparator output goes high and the circuit latches the high-side MOSFET driver OFF and the low-side MOSFET driver ON.

When the feedback voltage is lower than 70% of the reference voltage, the UVP comparator output goes high and an internal UVP delay counter begins counting. After 30 μ s, TPS53128 latches OFF both top and bottom MOSFET drivers. This function is enabled approximately $1.7 \times T_{SS}$ after power-on. The OVP and UVP latch off is reset when EN goes low level.

UVLO Protection

TPS53128 has V5FILT under voltage lock out protection (UVLO) that monitors the voltage of V5FILT pin.

When the V5FILT voltage is lower than UVLO threshold voltage, the device is shut off. All output drivers are OFF and output discharge is ON. The UVLO is non-latch protection.

Thermal Shutdown

The TPS53128 includes an over temperature protection shut-down feature. If the TPS53128 die temperature exceeds the OTP threshold (typically 150°C), both the high-side and low-side drivers are shut off, the output voltage discharge function is enabled and then the device is shut off until the die temperature drops. Thermal shutdown is a non-latch protection.

TYPICAL CHARACTERISTICS

VIN SUPPLY CURRENT
vs
JUNCTION TEMPERATURE

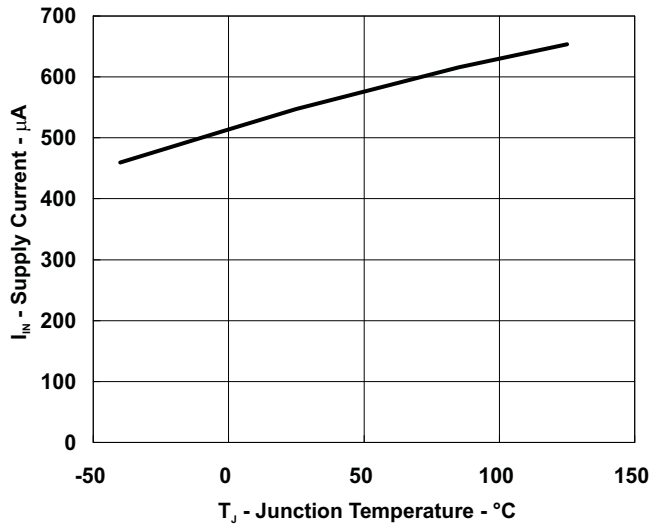

Figure 3.

VIN SHUTDOWN CURRENT
vs
JUNCTION TEMPERATURE

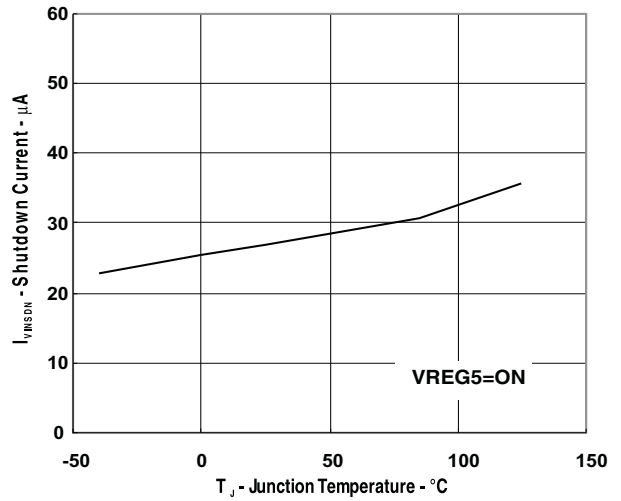

Figure 4.

TRIP SOURCE CURRENT
vs
JUNCTION TEMPERATURE

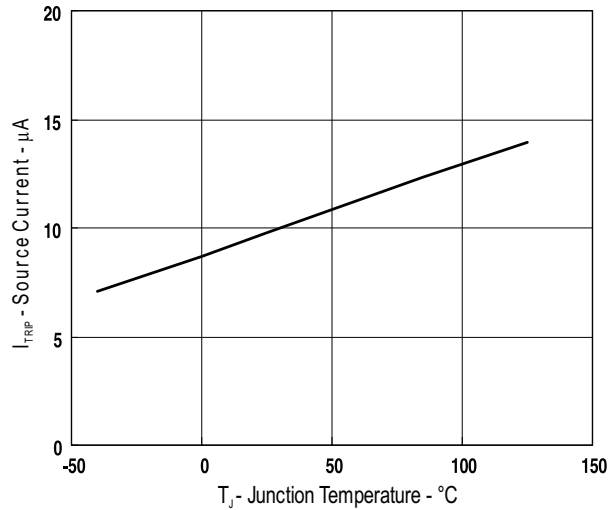

Figure 5.

VREG5 VOLTAGE
vs
JUNCTION TEMPERATURE

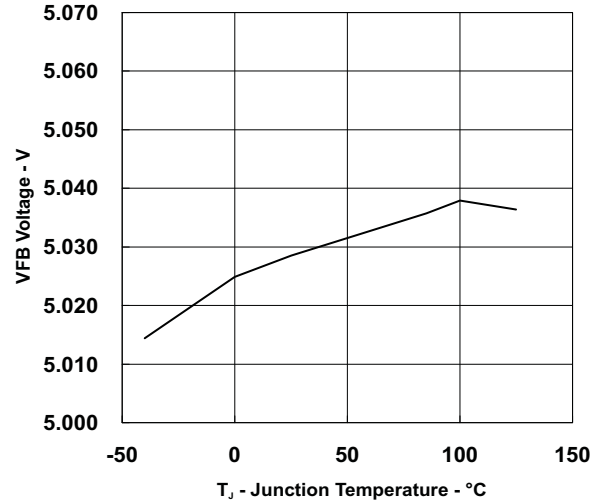

Figure 6.

TYPICAL CHARACTERISTICS (continued)

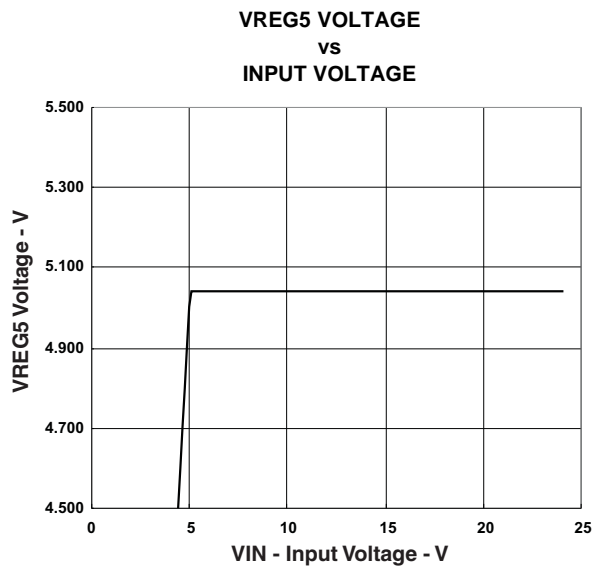

Figure 7.

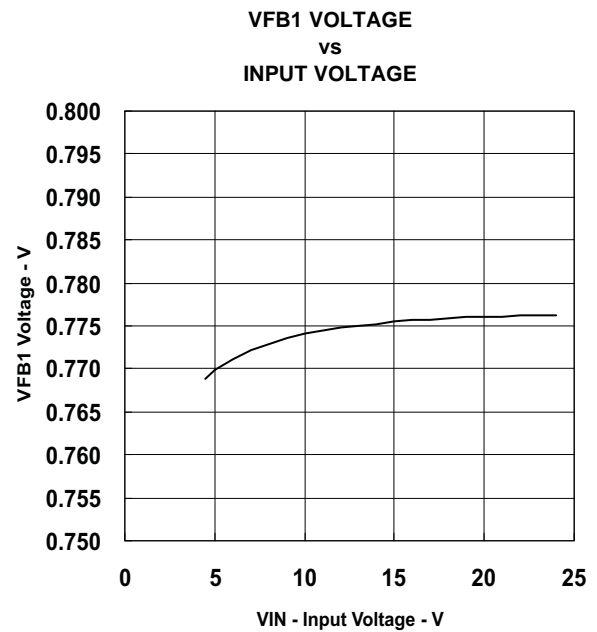

Figure 8.

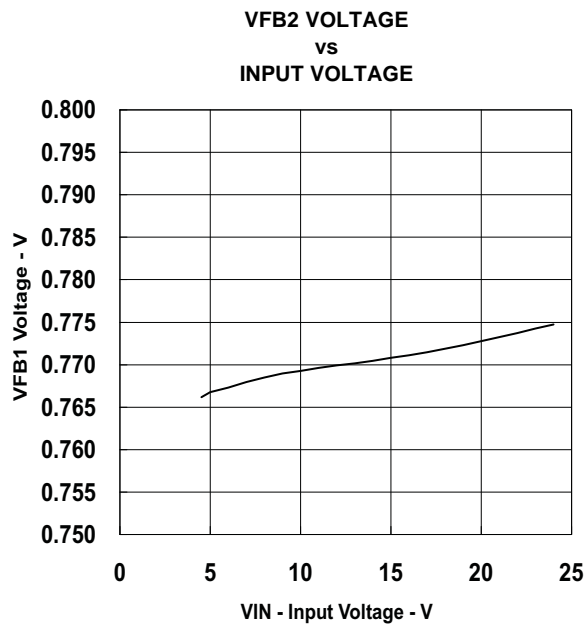

Figure 9.

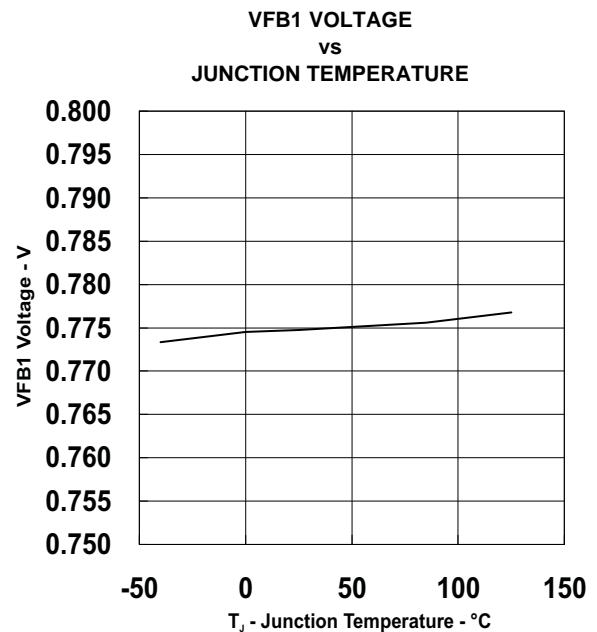
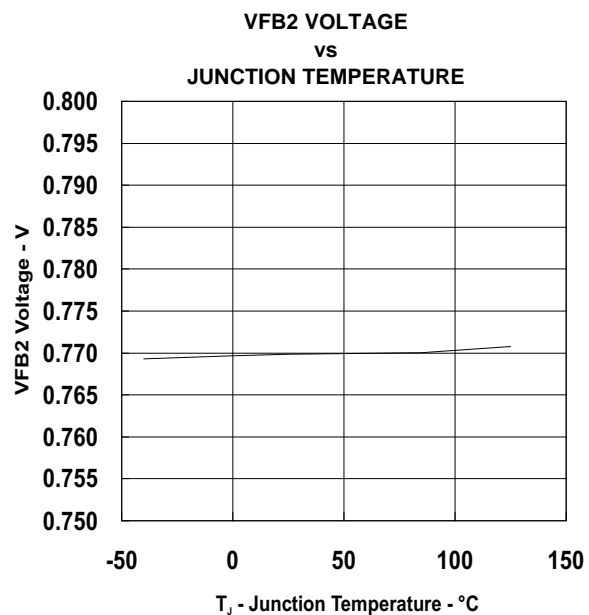

Figure 10.

TYPICAL CHARACTERISTICS (continued)



TYPICAL APPLICATION PERFORMANCE

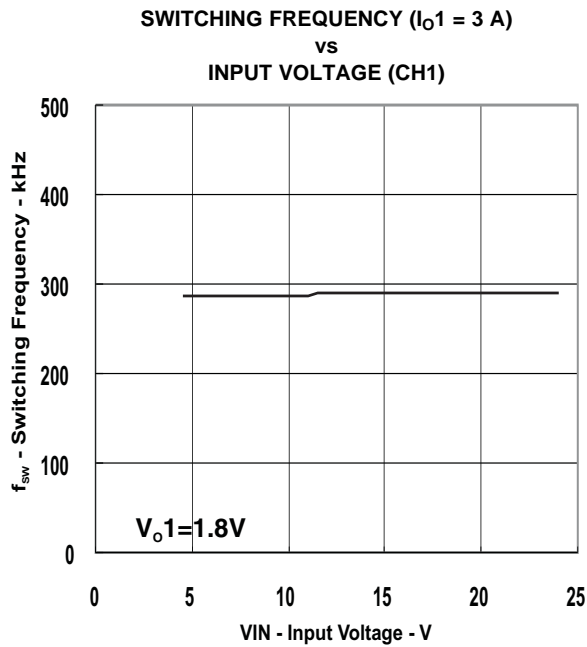

Figure 12.

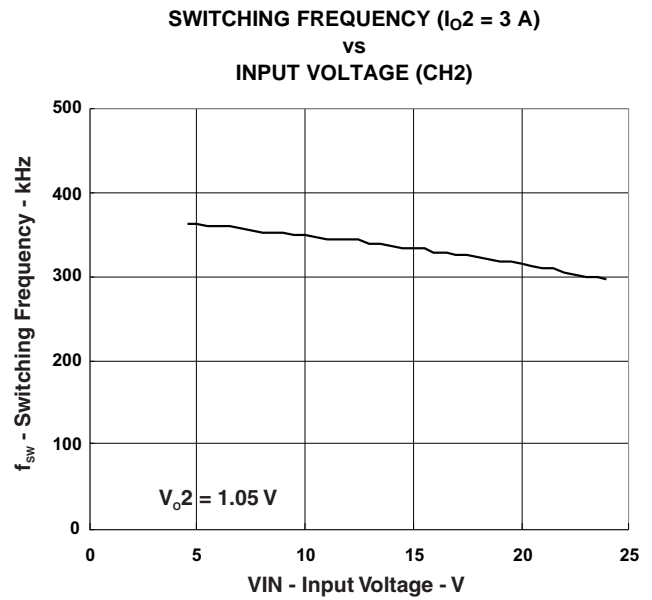

Figure 13.

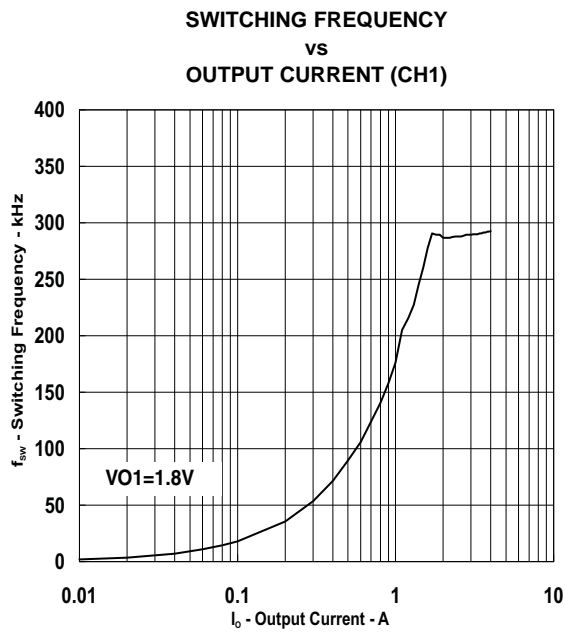

Figure 14.

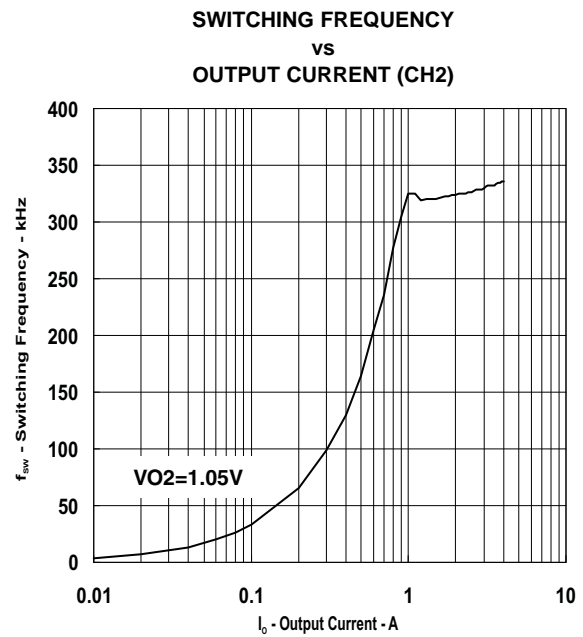

Figure 15.

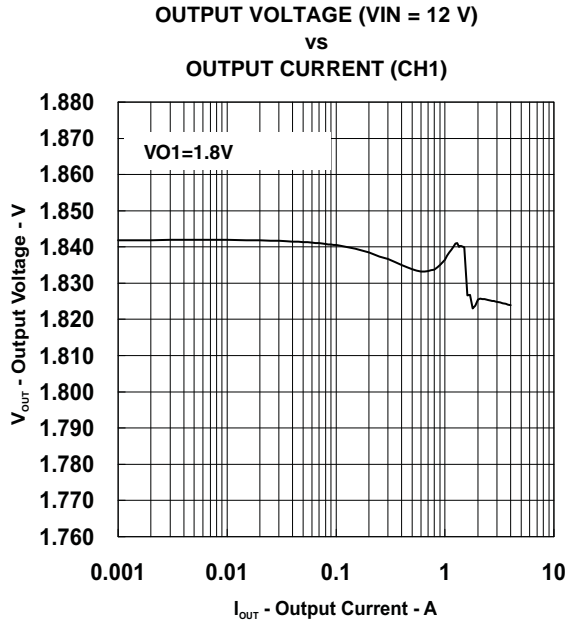

Figure 16.

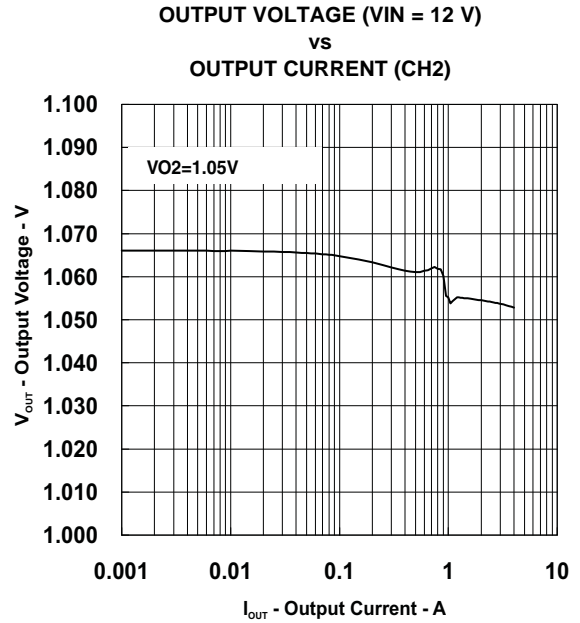

Figure 17.

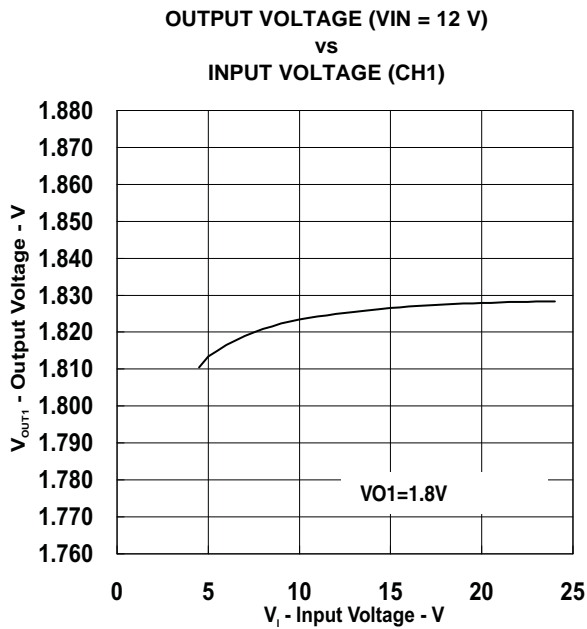

Figure 18.

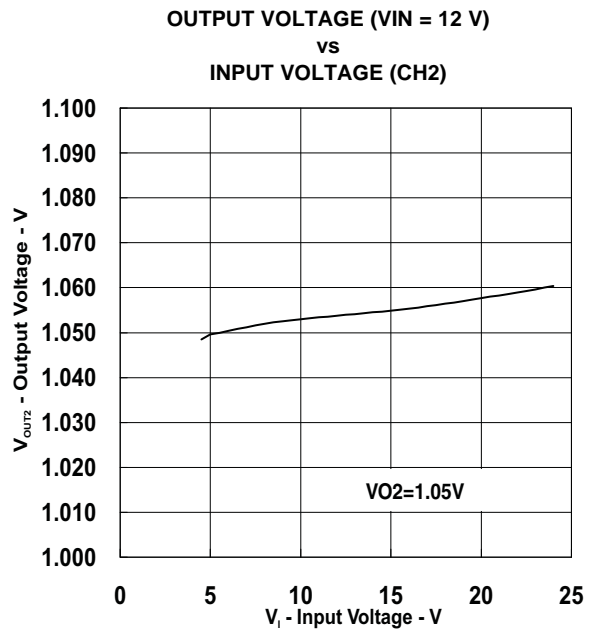

Figure 19.

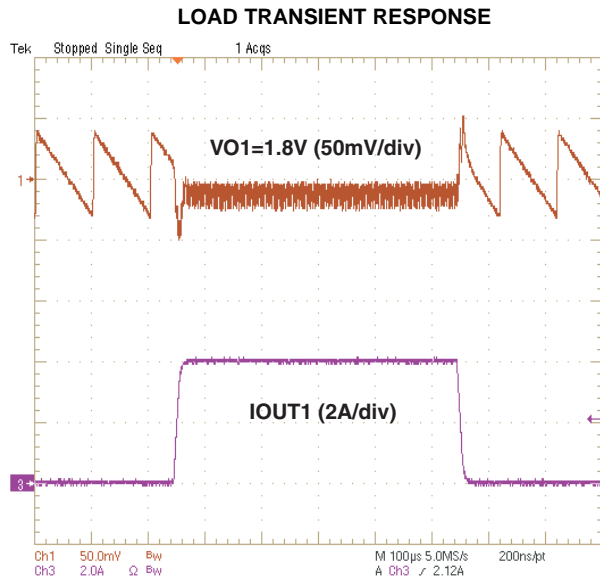

Figure 20.

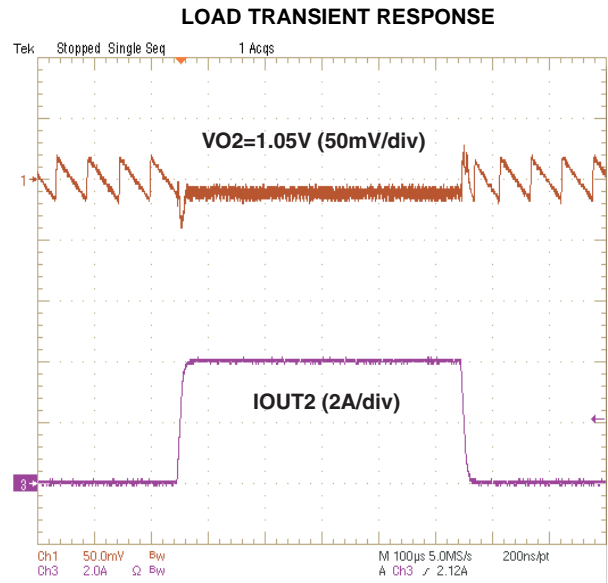

Figure 21.

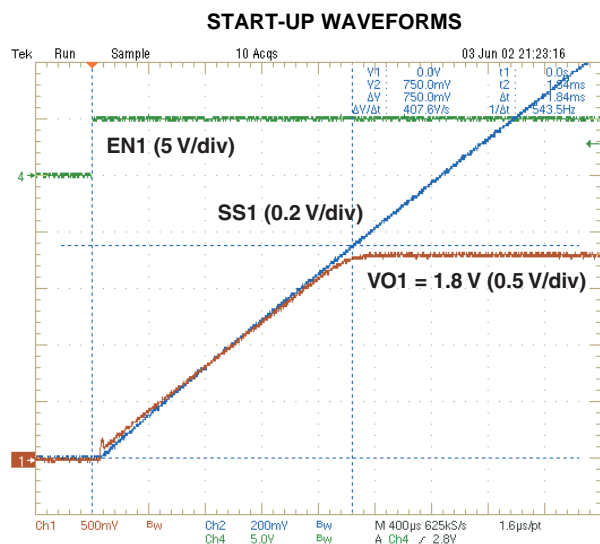

Figure 22.

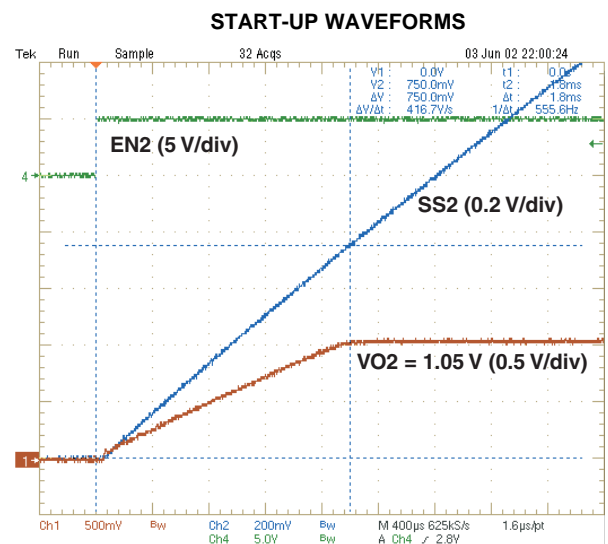

Figure 23.

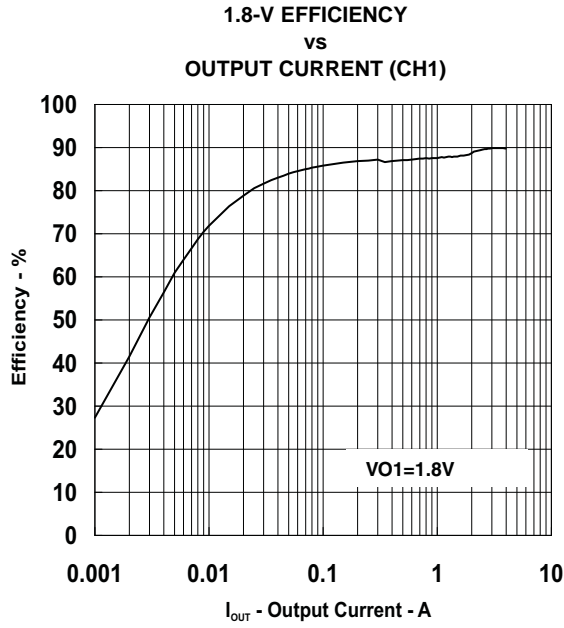

Figure 24.

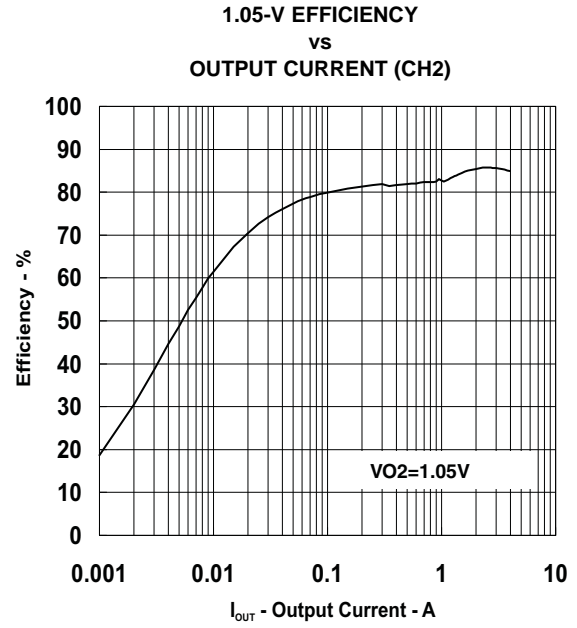

Figure 25.

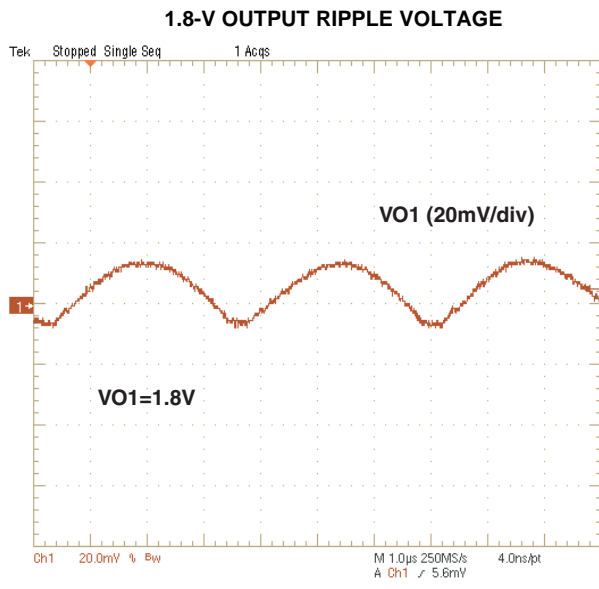

Figure 26.

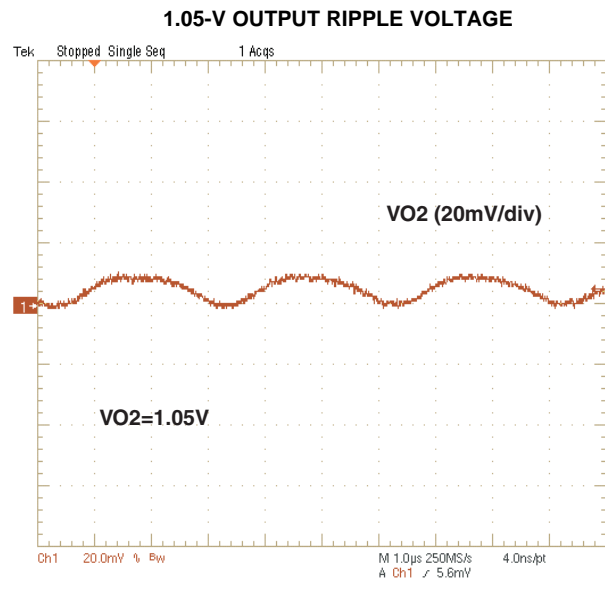

Figure 27.

APPLICATION INFORMATION

1. Choose inductor.

The inductance value is selected to provide approximately 30% peak to peak ripple current at maximum load. Larger ripple current increases output ripple voltage, improve S/N ratio and contribute to stable operation.

Equation 4 can be used to calculate L1.

$$L1 = \frac{(V_{IN(max)} - V_{O1})}{I_{L1(ripple)} \times f_{SW}} \times \frac{V_{O1}}{V_{IN(max)}} = \frac{3 \times (V_{IN(max)} - V_{O1})}{I_{O1} \times f_{SW}} \times \frac{V_{O1}}{V_{IN(max)}} \quad (4)$$

The inductors current ratings needs to support both the RMS (thermal) current and the Peak (saturation) current. The RMS and peak inductor current can be estimated as follows.

$$I_{L1(RIPPLE)} = \frac{V_{IN(MAX)} - V_{O1}}{L1 \cdot f_{SW}} \cdot \frac{V_{O1}}{V_{IN(MAX)}} \quad (5)$$

$$I_{L1(PEAK)} = \frac{V_{TRIP}}{R_{DS(ON)}} + I_{L1(RIPPLE)} \quad (6)$$

$$I_{L1(RMS)} = \sqrt{I_{O1}^2 + \frac{1}{12} (I_{L1(RIPPLE)})^2} \quad (7)$$

Note: The calculation above shall serve as a general reference. To further improve transient response, the output inductance could be reduced further. This needs to be considered along with the selection of the output capacitor.

2. Choose output capacitor.

The capacitor value and ESR determines the amount of output voltage ripple and load transient response. it is recommended to use a ceramic output capacitor.

$$C1 = \frac{I_{L1(RIPPLE)}}{8 \cdot V_{O1(RIPPLE)}} \cdot \frac{1}{f_{SW}} \quad (8)$$

$$C1 = \frac{\Delta I_{load}^2 \cdot L1}{2 \cdot V_{O1} \cdot \Delta V_{OS}} \quad (9)$$

$$C1 = \frac{\Delta I_{load}^2 \cdot L1}{2 \cdot K \cdot \Delta V_{US}} \quad (10)$$

Where

$$K = (V_{IN} - V_{O1}) \cdot \frac{T_{on}}{T_{on} + T_{min(off)}} \quad (11)$$

Select the capacitance value greater than the largest value calculated from Equation 8, Equation 9 and Equation 10. The capacitance for C1 should be greater than 66 μF.

Where

ΔV_{OS} = The allowable amount of overshoot voltage in load transition

ΔV_{US} = The allowable amount of undershoot voltage in load transition

T_{min(off)} = Minimum off time

3. Choose input capacitor.

The TPS53128 requires an input decoupling capacitor and a bulk capacitor is needed depending on the application. A minimum 10-μF high-quality ceramic capacitor is recommended for the input capacitor. The capacitor voltage rating needs to be greater than the maximum input voltage.

4. Choose bootstrap capacitor.

The TPS53128 requires a bootstrap capacitor from SW to VBST to provide the floating supply for the high-side drivers. A minimum 0.1- μ F high-quality ceramic capacitor is recommended. The voltage rating should be greater than 10 V.

5. Choose VREG5 and V5FILT capacitor.

The TPS53128 requires both the VREG5 regulator and V5FILT input are bypassed. A minimum 4.7- μ F high-quality ceramic capacitor must be connected between the VREG5 and GND for proper operation. A minimum 1- μ F high-quality ceramic capacitor must be connected between the V5FILT and GND for proper operation. Both of these capacitors' voltage ratings should be greater than 10 V.

6. Choose output voltage divider resistors.

The output voltage is set with a resistor divider from the output voltage node to the VFBx pin. It is recommended to use 1% tolerance or better resistors. Select R2 between 10 k Ω and 100 k Ω and use [Equation 12](#) or [Equation 13](#) to calculate R1.

$$V_{swinj} = (V_{IN} - V_{O1} \cdot 0.5875) \cdot \left(\frac{1}{f_{SW}}\right) \cdot \left(\frac{V_{O1}}{V_{IN}}\right) \cdot 4975 \quad (12)$$

$$R1 = \left(\frac{V_{O1}}{V_{FB} + \frac{V_{FB(RIPPLE)} + V_{swinj}}{2}} - 1 \right) \cdot R2 \quad (13)$$

Where

$V_{FB(RIPPLE)}$ = Ripple voltage at VFB

V_{swinj} = Ripple voltage at error comparator

7. Choose register setting for over current limit.

$$V_{TRIP} = \left(I_{OCL} - \frac{(V_{IN} - V_{O1})}{2 \cdot L1 \cdot f_{SW}} \cdot \frac{V_{O1}}{V_{IN}} \right) \cdot R_{DS(ON)} \quad (14)$$

$$R_{TRIP} (k\Omega) = \frac{V_{TRIP} (mV) - V_{OCLoff}}{I_{TRIP(min)} (\mu A)} \quad (15)$$

Where

$R_{DS(ON)}$ = Low side FET on-resistance

$I_{TRIP(min)}$ = TRIP pin source current (8.5 μ A)

V_{OCLoff} = Minimum over current limit offset voltage (–20 mV)

I_{OCL} = Over current limit

8. Choose soft start capacitor.

Soft start time equation is as follows.

$$C_{SS} = \frac{T_{SS} \cdot I_{SSC}}{V_{FB}} \quad (16)$$

LAYOUT SUGGESTIONS

- Keep the input switching current loop as small as possible.
- Place the input capacitor (C3,C6) close to the top switching FET. The output current loop should also be kept as small as possible.
- Keep the SW node as physically small and short as possible as to minimize parasitic capacitance and inductance and to minimize radiated emissions. Kelvin connections should be brought from the output to the feedback pin (FBx) of the device.
- Keep analog and non-switching components away from switching components.
- Make a single point connection from the signal ground to power ground.
- Do not allow switching current to flow under the device.

PACKAGING INFORMATION

Orderable Device	Status ⁽¹⁾	Package Type	Package Drawing	Pins	Package Qty	Eco Plan ⁽²⁾	Lead/ Ball Finish	MSL Peak Temp ⁽³⁾	Samples (Requires Login)
TPS53128PW	ACTIVE	TSSOP	PW	24	60	Green (RoHS & no Sb/Br)	CU NIPDAU	Level-1-260C-UNLIM	Purchase Samples
TPS53128PWR	ACTIVE	TSSOP	PW	24	2000	Green (RoHS & no Sb/Br)	CU NIPDAU	Level-1-260C-UNLIM	Request Free Samples
TPS53128RGER	ACTIVE	VQFN	RGE	24	3000	Green (RoHS & no Sb/Br)	CU NIPDAU	Level-2-260C-1 YEAR	Request Free Samples
TPS53128RGET	ACTIVE	VQFN	RGE	24	250	Green (RoHS & no Sb/Br)	CU NIPDAU	Level-2-260C-1 YEAR	Purchase Samples

⁽¹⁾ The marketing status values are defined as follows:

ACTIVE: Product device recommended for new designs.

LIFEBUY: TI has announced that the device will be discontinued, and a lifetime-buy period is in effect.

NRND: Not recommended for new designs. Device is in production to support existing customers, but TI does not recommend using this part in a new design.

PREVIEW: Device has been announced but is not in production. Samples may or may not be available.

OBSELETE: TI has discontinued the production of the device.

⁽²⁾ Eco Plan - The planned eco-friendly classification: Pb-Free (RoHS), Pb-Free (RoHS Exempt), or Green (RoHS & no Sb/Br) - please check <http://www.ti.com/productcontent> for the latest availability information and additional product content details.

TBD: The Pb-Free/Green conversion plan has not been defined.

Pb-Free (RoHS): TI's terms "Lead-Free" or "Pb-Free" mean semiconductor products that are compatible with the current RoHS requirements for all 6 substances, including the requirement that lead not exceed 0.1% by weight in homogeneous materials. Where designed to be soldered at high temperatures, TI Pb-Free products are suitable for use in specified lead-free processes.

Pb-Free (RoHS Exempt): This component has a RoHS exemption for either 1) lead-based flip-chip solder bumps used between the die and package, or 2) lead-based die adhesive used between the die and leadframe. The component is otherwise considered Pb-Free (RoHS compatible) as defined above.

Green (RoHS & no Sb/Br): TI defines "Green" to mean Pb-Free (RoHS compatible), and free of Bromine (Br) and Antimony (Sb) based flame retardants (Br or Sb do not exceed 0.1% by weight in homogeneous material)

⁽³⁾ MSL, Peak Temp. -- The Moisture Sensitivity Level rating according to the JEDEC industry standard classifications, and peak solder temperature.

Important Information and Disclaimer: The information provided on this page represents TI's knowledge and belief as of the date that it is provided. TI bases its knowledge and belief on information provided by third parties, and makes no representation or warranty as to the accuracy of such information. Efforts are underway to better integrate information from third parties. TI has taken and continues to take reasonable steps to provide representative and accurate information but may not have conducted destructive testing or chemical analysis on incoming materials and chemicals. TI and TI suppliers consider certain information to be proprietary, and thus CAS numbers and other limited information may not be available for release.

In no event shall TI's liability arising out of such information exceed the total purchase price of the TI part(s) at issue in this document sold by TI to Customer on an annual basis.

TAPE AND REEL INFORMATION
REEL DIMENSIONS

TAPE DIMENSIONS

A0	Dimension designed to accommodate the component width
B0	Dimension designed to accommodate the component length
K0	Dimension designed to accommodate the component thickness
W	Overall width of the carrier tape
P1	Pitch between successive cavity centers

TAPE AND REEL INFORMATION

*All dimensions are nominal

Device	Package Type	Package Drawing	Pins	SPQ	Reel Diameter (mm)	Reel Width W1 (mm)	A0 (mm)	B0 (mm)	K0 (mm)	P1 (mm)	W (mm)	Pin1 Quadrant
TPS53128PWR	TSSOP	PW	24	2000	330.0	16.4	6.95	8.3	1.6	8.0	16.0	Q1
TPS53128RGER	VQFN	RGE	24	3000	330.0	12.4	4.25	4.25	1.15	8.0	12.0	Q2
TPS53128RGET	VQFN	RGE	24	250	180.0	12.4	4.25	4.25	1.15	8.0	12.0	Q2

TAPE AND REEL BOX DIMENSIONS

*All dimensions are nominal

Device	Package Type	Package Drawing	Pins	SPQ	Length (mm)	Width (mm)	Height (mm)
TPS53128PWR	TSSOP	PW	24	2000	367.0	367.0	38.0
TPS53128RGER	VQFN	RGE	24	3000	367.0	367.0	35.0
TPS53128RGET	VQFN	RGE	24	250	210.0	185.0	35.0



MECHANICAL DATA

PW (R-PDSO-G24)

PLASTIC SMALL OUTLINE



4040064-6/G 02/11

- NOTES:
- A. All linear dimensions are in millimeters. Dimensioning and tolerancing per ASME Y14.5M-1994.
 - B. This drawing is subject to change without notice.
 -  Body length does not include mold flash, protrusions, or gate burrs. Mold flash, protrusions, or gate burrs shall not exceed 0,15 each side.
 -  Body width does not include interlead flash. Interlead flash shall not exceed 0,25 each side.
 - E. Falls within JEDEC MO-153

PW (R-PDSO-G24)

PLASTIC SMALL OUTLINE

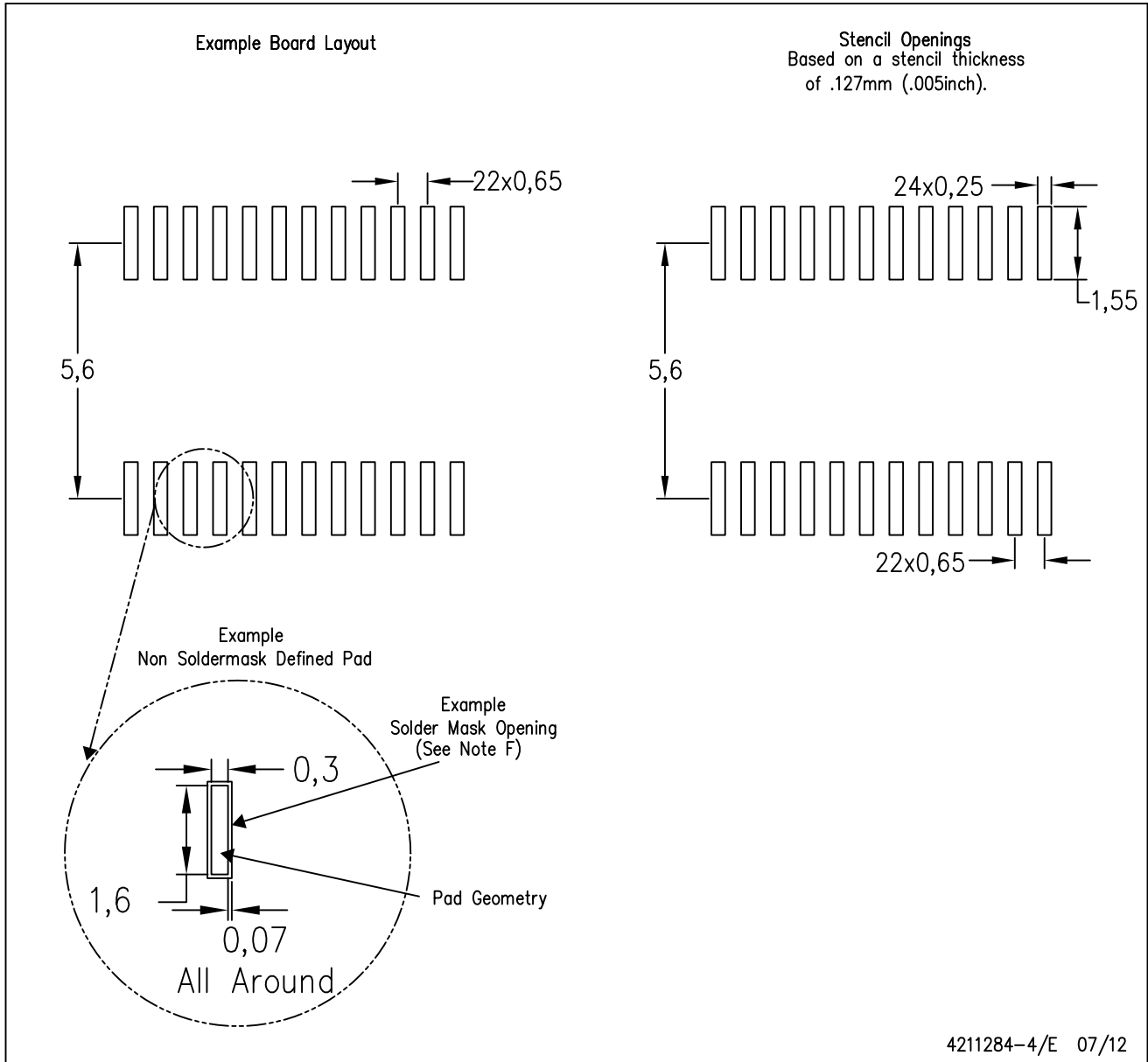

- NOTES:
- All linear dimensions are in millimeters.
 - This drawing is subject to change without notice.
 - Publication IPC-7351 is recommended for alternate design.
 - Laser cutting apertures with trapezoidal walls and also rounding corners will offer better paste release. Customers should contact their board assembly site for stencil design recommendations. Refer to IPC-7525 for other stencil recommendations.
 - Customers should contact their board fabrication site for solder mask tolerances between and around signal pads.

MECHANICAL DATA

RGE (S-PVQFN-N24)

PLASTIC QUAD FLATPACK NO-LEAD

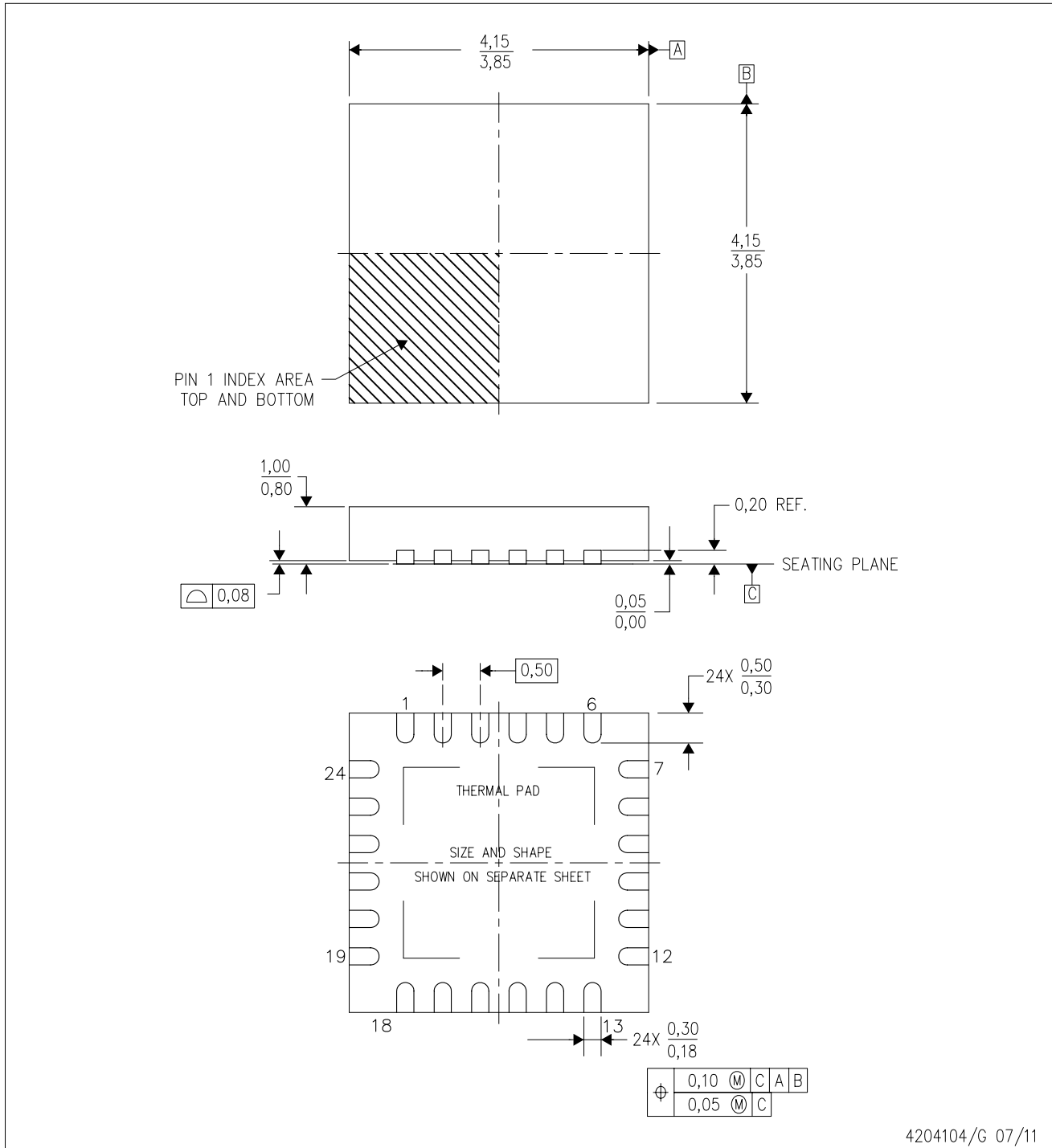

4204104/G 07/11

- NOTES:
- A. All linear dimensions are in millimeters. Dimensioning and tolerancing per ASME Y14.5M-1994.
 - B. This drawing is subject to change without notice.
 - C. Quad Flatpack, No-Leads (QFN) package configuration.
 - D. The package thermal pad must be soldered to the board for thermal and mechanical performance.
 - E. See the additional figure in the Product Data Sheet for details regarding the exposed thermal pad features and dimensions.
 - F. Falls within JEDEC MO-220.

THERMAL PAD MECHANICAL DATA

RGE (S-PVQFN-N24)

PLASTIC QUAD FLATPACK NO-LEAD

THERMAL INFORMATION

This package incorporates an exposed thermal pad that is designed to be attached directly to an external heatsink. The thermal pad must be soldered directly to the printed circuit board (PCB). After soldering, the PCB can be used as a heatsink. In addition, through the use of thermal vias, the thermal pad can be attached directly to the appropriate copper plane shown in the electrical schematic for the device, or alternatively, can be attached to a special heatsink structure designed into the PCB. This design optimizes the heat transfer from the integrated circuit (IC).

For information on the Quad Flatpack No-Lead (QFN) package and its advantages, refer to Application Report, QFN/SON PCB Attachment, Texas Instruments Literature No. SLUA271. This document is available at www.ti.com.

The exposed thermal pad dimensions for this package are shown in the following illustration.

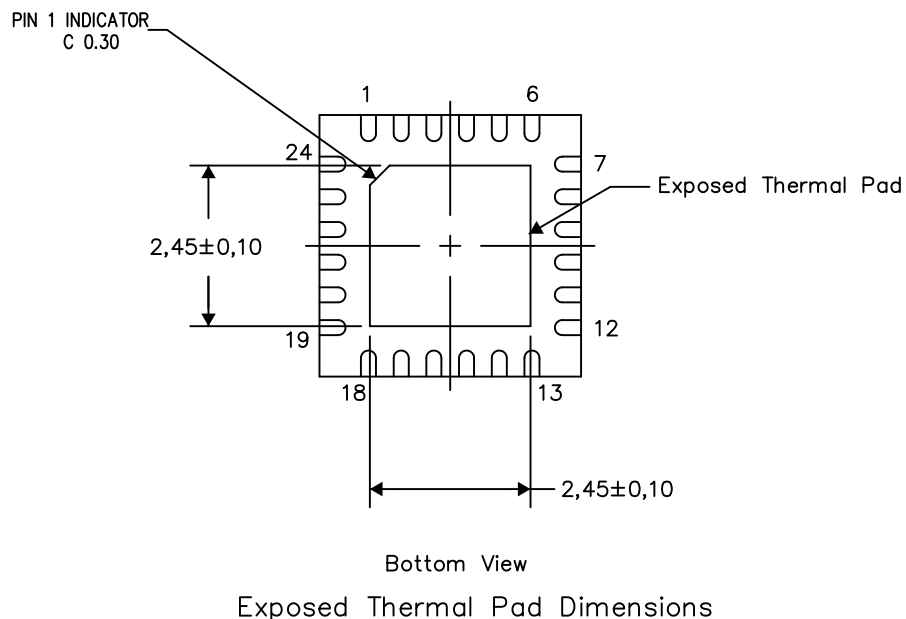

4206344-3/AA 04/12

NOTES: A. All linear dimensions are in millimeters

RGE (S-PVQFN-N24)

PLASTIC QUAD FLATPACK NO-LEAD

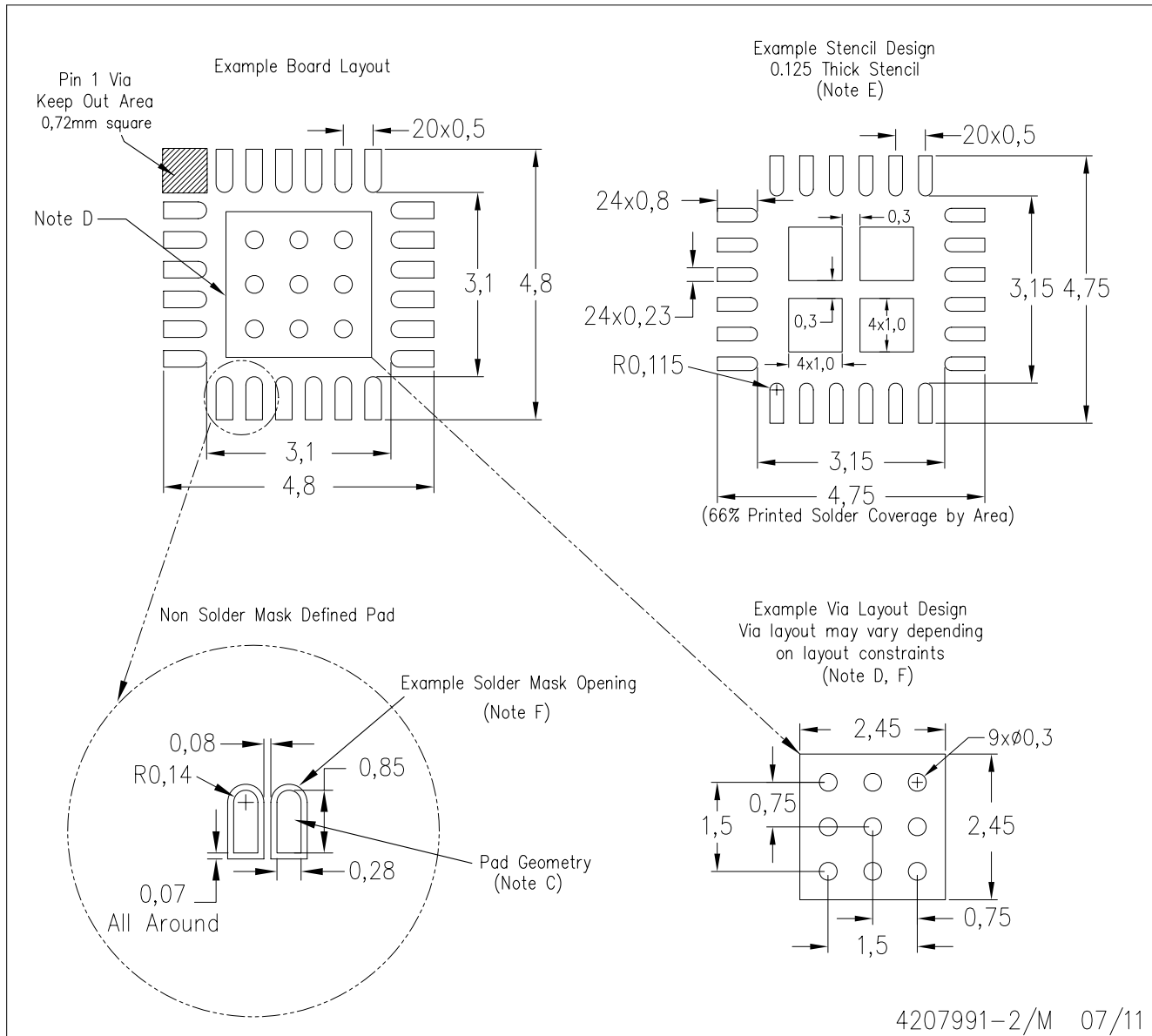

- NOTES:
- All linear dimensions are in millimeters.
 - This drawing is subject to change without notice.
 - Publication IPC-7351 is recommended for alternate designs.
 - This package is designed to be soldered to a thermal pad on the board. Refer to Application Note, Quad Flat-Pack Packages, Texas Instruments Literature No. SLUA271, and also the Product Data Sheets for specific thermal information, via requirements, and recommended board layout. These documents are available at www.ti.com <<http://www.ti.com>>.
 - Laser cutting apertures with trapezoidal walls and also rounding corners will offer better paste release. Customers should contact their board assembly site for stencil design recommendations. Refer to IPC 7525 for stencil design considerations.
 - Customers should contact their board fabrication site for recommended solder mask tolerances and via tenting recommendations for vias placed in the thermal pad.

IMPORTANT NOTICE

Texas Instruments Incorporated and its subsidiaries (TI) reserve the right to make corrections, enhancements, improvements and other changes to its semiconductor products and services per JESD46C and to discontinue any product or service per JESD48B. Buyers should obtain the latest relevant information before placing orders and should verify that such information is current and complete. All semiconductor products (also referred to herein as "components") are sold subject to TI's terms and conditions of sale supplied at the time of order acknowledgment.

TI warrants performance of its components to the specifications applicable at the time of sale, in accordance with the warranty in TI's terms and conditions of sale of semiconductor products. Testing and other quality control techniques are used to the extent TI deems necessary to support this warranty. Except where mandated by applicable law, testing of all parameters of each component is not necessarily performed.

TI assumes no liability for applications assistance or the design of Buyers' products. Buyers are responsible for their products and applications using TI components. To minimize the risks associated with Buyers' products and applications, Buyers should provide adequate design and operating safeguards.

TI does not warrant or represent that any license, either express or implied, is granted under any patent right, copyright, mask work right, or other intellectual property right relating to any combination, machine, or process in which TI components or services are used. Information published by TI regarding third-party products or services does not constitute a license to use such products or services or a warranty or endorsement thereof. Use of such information may require a license from a third party under the patents or other intellectual property of the third party, or a license from TI under the patents or other intellectual property of TI.

Reproduction of significant portions of TI information in TI data books or data sheets is permissible only if reproduction is without alteration and is accompanied by all associated warranties, conditions, limitations, and notices. TI is not responsible or liable for such altered documentation. Information of third parties may be subject to additional restrictions.

Resale of TI components or services with statements different from or beyond the parameters stated by TI for that component or service voids all express and any implied warranties for the associated TI component or service and is an unfair and deceptive business practice. TI is not responsible or liable for any such statements.

Buyer acknowledges and agrees that it is solely responsible for compliance with all legal, regulatory and safety-related requirements concerning its products, and any use of TI components in its applications, notwithstanding any applications-related information or support that may be provided by TI. Buyer represents and agrees that it has all the necessary expertise to create and implement safeguards which anticipate dangerous consequences of failures, monitor failures and their consequences, lessen the likelihood of failures that might cause harm and take appropriate remedial actions. Buyer will fully indemnify TI and its representatives against any damages arising out of the use of any TI components in safety-critical applications.

In some cases, TI components may be promoted specifically to facilitate safety-related applications. With such components, TI's goal is to help enable customers to design and create their own end-product solutions that meet applicable functional safety standards and requirements. Nonetheless, such components are subject to these terms.

No TI components are authorized for use in FDA Class III (or similar life-critical medical equipment) unless authorized officers of the parties have executed a special agreement specifically governing such use.

Only those TI components which TI has specifically designated as military grade or "enhanced plastic" are designed and intended for use in military/aerospace applications or environments. Buyer acknowledges and agrees that any military or aerospace use of TI components which have **not** been so designated is solely at the Buyer's risk, and that Buyer is solely responsible for compliance with all legal and regulatory requirements in connection with such use.

TI has specifically designated certain components which meet ISO/TS16949 requirements, mainly for automotive use. Components which have not been so designated are neither designed nor intended for automotive use; and TI will not be responsible for any failure of such components to meet such requirements.

Products

Audio	www.ti.com/audio
Amplifiers	amplifier.ti.com
Data Converters	dataconverter.ti.com
DLP® Products	www.dlp.com
DSP	dsp.ti.com
Clocks and Timers	www.ti.com/clocks
Interface	interface.ti.com
Logic	logic.ti.com
Power Mgmt	power.ti.com
Microcontrollers	microcontroller.ti.com
RFID	www.ti-rfid.com
OMAP Mobile Processors	www.ti.com/omap
Wireless Connectivity	www.ti.com/wirelessconnectivity

Applications

Automotive and Transportation	www.ti.com/automotive
Communications and Telecom	www.ti.com/communications
Computers and Peripherals	www.ti.com/computers
Consumer Electronics	www.ti.com/consumer-apps
Energy and Lighting	www.ti.com/energy
Industrial	www.ti.com/industrial
Medical	www.ti.com/medical
Security	www.ti.com/security
Space, Avionics and Defense	www.ti.com/space-avionics-defense
Video and Imaging	www.ti.com/video

TI E2E Community e2e.ti.com