

## Cap-Free, NMOS, 400mA Low-Dropout Regulator with Reverse Current Protection

Check for Samples: [TPS73601-Q1](#), [TPS73625-Q1](#), [TPS73633-Q1](#)

### FEATURES

- Qualified for Automotive Applications
- Stable with No Output Capacitor or Any Value or Type of Capacitor
- Input Voltage Range of 1.7V to 5.5V
- Ultra-Low Dropout Voltage: 75mV typ
- Excellent Load Transient Response—with or without Optional Output Capacitor
- New NMOS Topology Delivers Low Reverse Leakage Current
- Low Noise:  $30\mu\text{V}_{\text{RMS}}$  typ (10Hz to 100kHz)
- 0.5% Initial Accuracy
- 1% Overall Accuracy Over Line, Load, and Temperature
- Less Than  $1\mu\text{A}$  max  $I_{\text{Q}}$  in Shutdown Mode
- Thermal Shutdown and Specified Min/Max Current Limit Protection
- Available in Multiple Output Voltage Versions
  - Fixed Outputs of 1.20V to 3.3V
  - Adjustable Output from 1.20V to 5.5V

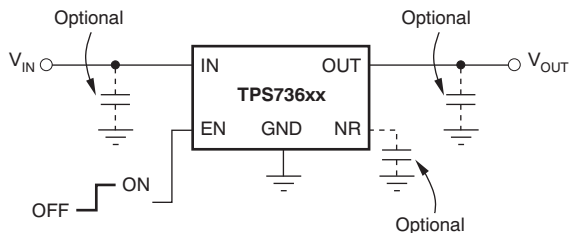

Typical Application Circuit for Fixed-Voltage Versions

### DESCRIPTION

The TPS736xx family of low-dropout (LDO) linear voltage regulators uses a new topology: an NMOS pass element in a voltage-follower configuration. This topology is stable using output capacitors with low ESR, and even allows operation without a capacitor. It also provides high reverse blockage (low reverse current) and ground pin current that is nearly constant over all values of output current.

The TPS736xx uses an advanced BiCMOS process to yield high precision while delivering very low dropout voltages and low ground pin current. Current consumption, when not enabled, is under  $1\mu\text{A}$  and ideal for portable applications. The extremely low output noise ( $30\mu\text{V}_{\text{RMS}}$  with  $0.1\mu\text{F}$   $C_{\text{NR}}$ ) is ideal for powering VCOs. These devices are protected by thermal shutdown and foldback current limit.

DBV PACKAGE  
SOT23  
(TOP VIEW)

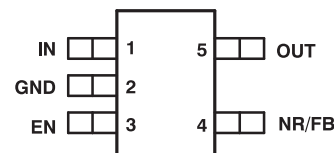

Please be aware that an important notice concerning availability, standard warranty, and use in critical applications of Texas Instruments semiconductor products and disclaimers thereto appears at the end of this data sheet.

All trademarks are the property of their respective owners.



This integrated circuit can be damaged by ESD. Texas Instruments recommends that all integrated circuits be handled with appropriate precautions. Failure to observe proper handling and installation procedures can cause damage.

ESD damage can range from subtle performance degradation to complete device failure. Precision integrated circuits may be more susceptible to damage because very small parametric changes could cause the device not to meet its published specifications.

### ORDERING INFORMATION<sup>(1)</sup>

| T <sub>A</sub> | OUTPUT VOLTAGE | PACKAGE <sup>(2)</sup> |              | ORDERABLE PART NUMBER          | TOP-SIDE MARKING |
|----------------|----------------|------------------------|--------------|--------------------------------|------------------|
| –40°C to 125°C | adjustable     | SOT (SOT-23) – DBV     | Reel of 3000 | TPS73601QDBVRQ1                | PTWQ             |
|                | 2.5 V          |                        |              | TPS73625QDBVRQ1 <sup>(3)</sup> | PREVIEW          |
|                | 3.3 V          |                        |              | TPS73633QDBVRQ1 <sup>(3)</sup> | PREVIEW          |

- (1) For the most current package and ordering information, see the Package Option Addendum at the end of this document, or see the TI web site at [www.ti.com](http://www.ti.com).  
 (2) Package drawings, thermal data, and symbolization are available at [www.ti.com/packaging](http://www.ti.com/packaging).  
 (3) Product Preview

### ABSOLUTE MAXIMUM RATINGS

over operating free-air temperature range unless otherwise noted<sup>(1)</sup>

| PARAMETER                                  | TPS736xx                                      | UNIT |
|--------------------------------------------|-----------------------------------------------|------|
| V <sub>IN</sub> range                      | –0.3 to 6.0                                   | V    |
| V <sub>EN</sub> range                      | –0.3 to 6.0                                   | V    |
| V <sub>OUT</sub> range                     | –0.3 to 5.5                                   | V    |
| V <sub>NR</sub> , V <sub>FB</sub> range    | –0.3 to 6.0                                   | V    |
| Peak output current                        | Internally limited                            |      |
| Output short-circuit duration              | Indefinite                                    |      |
| Continuous total power dissipation         | See <a href="#">Thermal Information</a> Table |      |
| Junction temperature range, T <sub>J</sub> | –40 to +150                                   | °C   |
| Storage temperature range                  | –65 to +150                                   | °C   |

- (1) Stresses beyond those listed under Absolute Maximum Ratings may cause permanent damage to the device. These are stress ratings only, and functional operation of the device at these or any other conditions beyond those indicated under the [Electrical Characteristics](#) is not implied. Exposure to absolute maximum rated conditions for extended periods may affect device reliability.

**THERMAL INFORMATION**

| THERMAL METRIC <sup>(1)</sup> |                                                             | DBV <sup>(2)</sup> | UNITS |
|-------------------------------|-------------------------------------------------------------|--------------------|-------|
|                               |                                                             | 5 PINS             |       |
| $\theta_{JA}$                 | Junction-to-ambient thermal resistance <sup>(3)</sup>       | 180                | °C/W  |
| $\theta_{JcTop}$              | Junction-to-case (top) thermal resistance <sup>(4)</sup>    | 64                 |       |
| $\theta_{JB}$                 | Junction-to-board thermal resistance <sup>(5)</sup>         | 35                 |       |
| $\psi_{JT}$                   | Junction-to-top characterization parameter <sup>(6)</sup>   | N/A                |       |
| $\psi_{JB}$                   | Junction-to-board characterization parameter <sup>(7)</sup> | N/A                |       |
| $\theta_{JcBot}$              | Junction-to-case (bottom) thermal resistance <sup>(8)</sup> | N/A                |       |

- (1) For more information about traditional and new thermal metrics, see the *IC Package Thermal Metrics* application report, [SPRA953A](#).
- (2) Thermal data for the DBV package is derived by thermal simulations based on JEDEC-standard methodology as specified in the JESD51 series. The following assumptions are used in the simulations:
  - (a) DBV: There is no exposed pad with the DBV package.
  - (b) DBV: The top and bottom copper layers are assumed to have a 20% thermal conductivity of copper representing a 20% copper coverage.
  - (c) These data were generated with only a single device at the center of a JEDEC high-K (2s2p) board with 3in x 3in copper area. To understand the effects of the copper area on thermal performance, see the [Power Dissipation](#) section of this data sheet.
- (3) The junction-to-ambient thermal resistance under natural convection is obtained in a simulation on a JEDEC-standard, high-K board, as specified in JESD51-7, in an environment described in JESD51-2a.
- (4) The junction-to-case (top) thermal resistance is obtained by simulating a cold plate test on the top of the package. No specific JEDEC-standard test exists, but a close description can be found in the ANSI SEMI standard G30-88.
- (5) The junction-to-board thermal resistance is obtained by simulating in an environment with a ring cold plate fixture to control the PCB temperature, as described in JESD51-8.
- (6) The junction-to-top characterization parameter,  $\psi_{JT}$ , estimates the junction temperature of a device in a real system and is extracted from the simulation data to obtain  $\theta_{JA}$  using a procedure described in JESD51-2a (sections 6 and 7).
- (7) The junction-to-board characterization parameter,  $\psi_{JB}$ , estimates the junction temperature of a device in a real system and is extracted from the simulation data to obtain  $\theta_{JA}$  using a procedure described in JESD51-2a (sections 6 and 7).
- (8) The junction-to-case (bottom) thermal resistance is obtained by simulating a cold plate test on the exposed (power) pad. No specific JEDEC standard test exists, but a close description can be found in the ANSI SEMI standard G30-88.

## ELECTRICAL CHARACTERISTICS

Over operating temperature range ( $T_A = -40^{\circ}\text{C}$  to  $+125^{\circ}\text{C}$ ),  $V_{IN} = V_{OUT(nom)} + 0.5\text{V}^{(1)}$ ,  $I_{OUT} = 10\text{mA}$ ,  $V_{EN} = 1.7\text{V}$ , and  $C_{OUT} = 0.1\mu\text{F}$ , unless otherwise noted. Typical values are at  $T_J = +25^{\circ}\text{C}$ .

| PARAMETER                         |                                                                             | TEST CONDITIONS                                                                                                          | MIN                         | TYP                  | MAX            | UNIT                |
|-----------------------------------|-----------------------------------------------------------------------------|--------------------------------------------------------------------------------------------------------------------------|-----------------------------|----------------------|----------------|---------------------|
| $V_{IN}$                          | Input voltage range <sup>(1) (2)</sup>                                      |                                                                                                                          | 1.7                         |                      | 5.5            | V                   |
| $V_{FB}$                          | Internal reference (TPS73601)                                               | $T_J = +25^{\circ}\text{C}$                                                                                              | 1.198                       | 1.20                 | 1.210          | V                   |
| $V_{OUT}$                         | Output voltage range (TPS73601) <sup>(3)</sup>                              |                                                                                                                          | $V_{FB}$                    |                      | $5.5 - V_{DO}$ | V                   |
|                                   | Accuracy <sup>(1)</sup><br><sup>(4)</sup>                                   | Nominal                                                                                                                  | $T_J = +25^{\circ}\text{C}$ |                      | -0.5           | +0.5                |
| over $V_{IN}$ , $I_{OUT}$ , and T |                                                                             | $V_{OUT} + 0.5\text{V} \leq V_{IN} \leq 5.5\text{V}$ ;<br>$10\text{mA} \leq I_{OUT} \leq 400\text{mA}$                   |                             | -1.0                 | $\pm 0.5$      | +1.0                |
| $\Delta V_{OUT}\%/\Delta V_{IN}$  | Line regulation <sup>(1)</sup>                                              | $V_{O(nom)} + 0.5\text{V} \leq V_{IN} \leq 5.5\text{V}$                                                                  |                             | 0.01                 |                | %/V                 |
| $\Delta V_{OUT}\%/\Delta I_{OUT}$ | Load regulation                                                             | $1\text{mA} \leq I_{OUT} \leq 400\text{mA}$                                                                              |                             | 0.002                |                | %/mA                |
|                                   |                                                                             | $10\text{mA} \leq I_{OUT} \leq 400\text{mA}$                                                                             |                             | 0.0005               |                |                     |
| $V_{DO}$                          | Dropout voltage <sup>(5)</sup><br>( $V_{IN} = V_{OUT(nom)} - 0.1\text{V}$ ) | $I_{OUT} = 400\text{mA}$                                                                                                 |                             | 75                   | 200            | mV                  |
| $Z_O(\text{DO})$                  | Output impedance in dropout                                                 | $1.7\text{V} \leq V_{IN} \leq V_{OUT} + V_{DO}$                                                                          |                             | 0.25                 |                | $\Omega$            |
| $I_{CL}$                          | Output current limit                                                        | $V_{OUT} = 0.9 \times V_{OUT(nom)}$                                                                                      | 400                         | 650                  | 800            | mA                  |
|                                   |                                                                             | $3.6\text{V} \leq V_{IN} \leq 4.2\text{V}$ , $0^{\circ}\text{C} \leq T_J \leq +70^{\circ}\text{C}$                       | 500                         |                      | 800            | mA                  |
| $I_{SC}$                          | Short-circuit current                                                       | $V_{OUT} = 0\text{V}$                                                                                                    |                             | 450                  |                | mA                  |
| $I_{REV}$                         | Reverse leakage current <sup>(6)</sup> ( $-I_{IN}$ )                        | $V_{EN} \leq 0.5\text{V}$ , $0\text{V} \leq V_{IN} \leq V_{OUT}$                                                         |                             | 0.1                  | 10             | $\mu\text{A}$       |
| $I_{GND}$                         | GND pin current                                                             | $I_{OUT} = 10\text{mA}$ ( $I_Q$ )                                                                                        |                             | 400                  | 550            | $\mu\text{A}$       |
|                                   |                                                                             | $I_{OUT} = 400\text{mA}$                                                                                                 |                             | 800                  | 1000           |                     |
| $I_{SHDN}$                        | Shutdown current ( $I_{GND}$ )                                              | $V_{EN} \leq 0.5\text{V}$ , $V_{OUT} \leq V_{IN} \leq 5.5$ ,<br>$-40^{\circ}\text{C} \leq T_J \leq +100^{\circ}\text{C}$ |                             | 0.02                 | 1.3            | $\mu\text{A}$       |
| $I_{FB}$                          | FB pin current (TPS73601)                                                   |                                                                                                                          |                             | 0.1                  | 0.45           | $\mu\text{A}$       |
| PSRR                              | Power-supply rejection ratio (ripple rejection)                             | $f = 100\text{Hz}$ , $I_{OUT} = 400\text{mA}$                                                                            |                             | 58                   |                | dB                  |
|                                   |                                                                             | $f = 10\text{KHz}$ , $I_{OUT} = 400\text{mA}$                                                                            |                             | 37                   |                |                     |
| $V_N$                             | Output noise voltage<br>BW = 10Hz – 100KHz                                  | $C_{OUT} = 10\mu\text{F}$ , No $C_{NR}$                                                                                  |                             | $27 \times V_{OUT}$  |                | $\mu\text{V}_{RMS}$ |
|                                   |                                                                             | $C_{OUT} = 10\mu\text{F}$ , $C_{NR} = 0.01\mu\text{F}$                                                                   |                             | $8.5 \times V_{OUT}$ |                |                     |
| $t_{STR}$                         | Startup time                                                                | $V_{OUT} = 3\text{V}$ , $R_L = 30\Omega$ $C_{OUT} = 1\mu\text{F}$ ,<br>$C_{NR} = 0.01\mu\text{F}$                        |                             | 600                  |                | $\mu\text{s}$       |
| $V_{EN}(\text{HI})$               | EN pin high (enabled)                                                       |                                                                                                                          | 1.7                         |                      | $V_{IN}$       | V                   |
| $V_{EN}(\text{LO})$               | EN pin low (shutdown)                                                       |                                                                                                                          | 0                           |                      | 0.5            | V                   |
| $I_{EN}(\text{HI})$               | EN pin current (enabled)                                                    | $V_{EN} = 5.5\text{V}$                                                                                                   |                             | 0.02                 | 0.1            | $\mu\text{A}$       |
| $T_{SD}$                          | Thermal shutdown temperature                                                | Shutdown, temperature increasing                                                                                         |                             | +160                 |                | $^{\circ}\text{C}$  |
|                                   |                                                                             | Reset, temperature decreasing                                                                                            |                             | +140                 |                |                     |
| $T_A$                             | Operating ambient temperature                                               |                                                                                                                          | -40                         |                      | +125           | $^{\circ}\text{C}$  |

- (1) Minimum  $V_{IN} = V_{OUT} + V_{DO}$  or 1.7V, whichever is greater.
- (2) For  $V_{OUT(nom)} < 1.6\text{V}$ , when  $V_{IN} \leq 1.6\text{V}$ , the output will lock to  $V_{IN}$  and may result in a damaging over-voltage level on the output. To avoid this situation, disable the device before powering down the  $V_{IN}$ .
- (3) TPS73601 is tested at  $V_{OUT} = 2.5\text{V}$ .
- (4) Tolerance of external resistors not included in this specification.
- (5)  $V_{DO}$  is not measured for fixed output versions with  $V_{OUT(nom)} < 1.8\text{V}$ .
- (6) Fixed-voltage versions only; refer to [Applications](#) section for more information.

FUNCTIONAL BLOCK DIAGRAMS

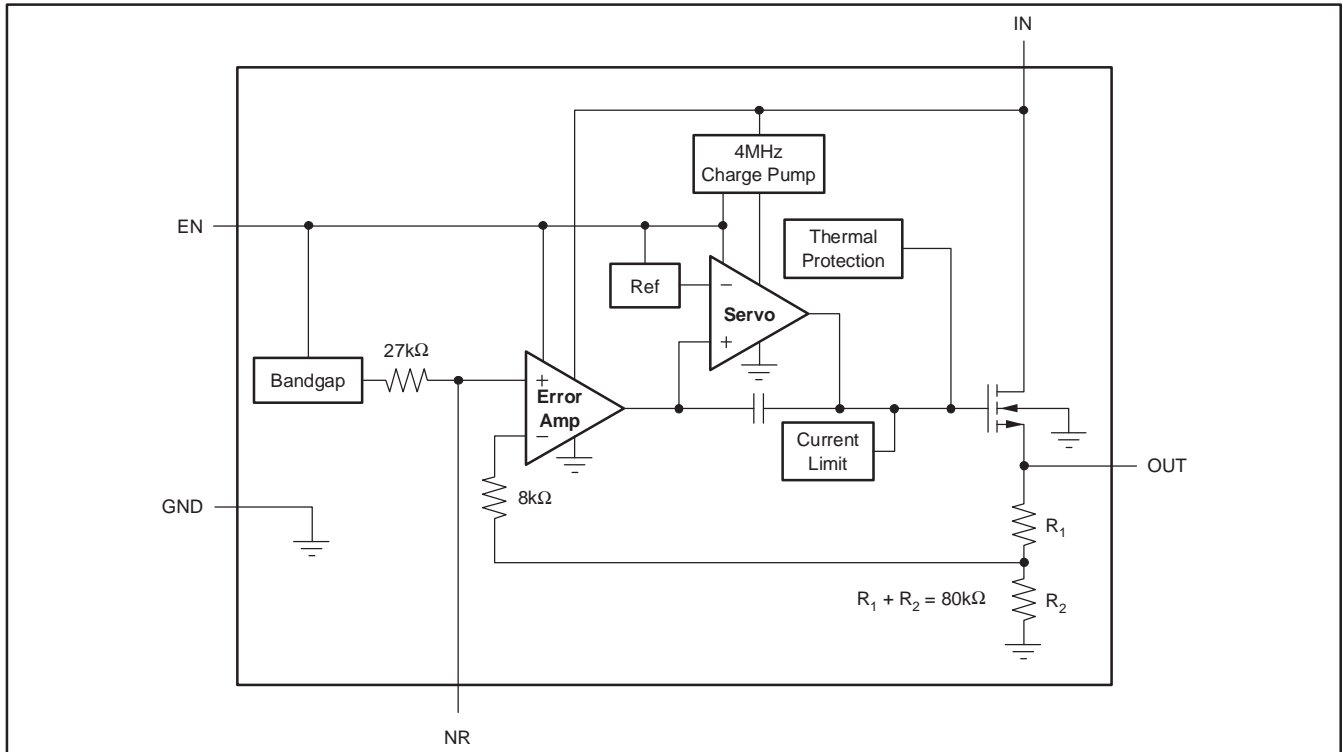

Figure 1. Fixed Voltage Version

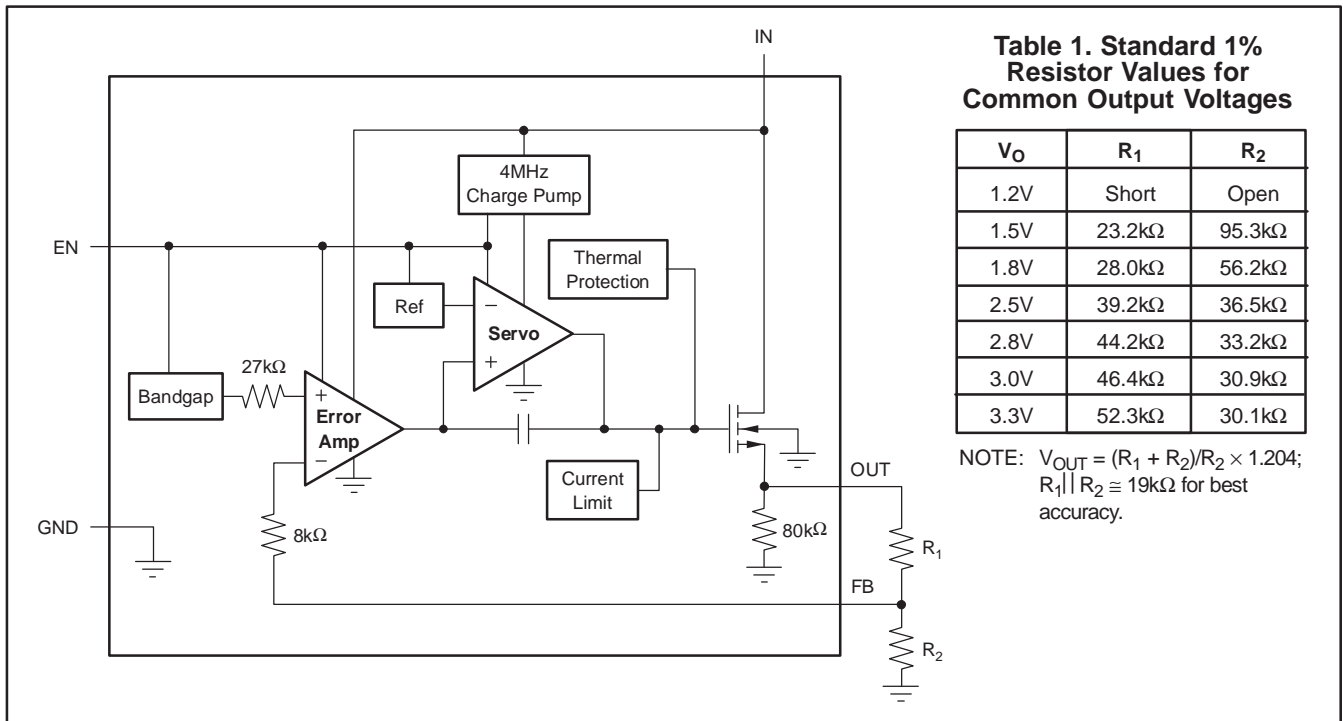
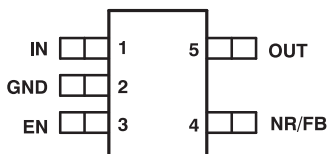

Figure 2. Adjustable Voltage Version

### PIN CONFIGURATION

DBV PACKAGE  
SOT23  
(TOP VIEW)



### PIN DESCRIPTIONS

| NAME | SOT23 (DBV) PIN NO. | DESCRIPTION                                                                                                                                                                                                                                                |
|------|---------------------|------------------------------------------------------------------------------------------------------------------------------------------------------------------------------------------------------------------------------------------------------------|
| IN   | 1                   | Input supply                                                                                                                                                                                                                                               |
| GND  | 2                   | Ground                                                                                                                                                                                                                                                     |
| EN   | 3                   | Driving the enable pin (EN) high turns on the regulator. Driving this pin low puts the regulator into shutdown mode. Refer to the <a href="#">Shutdown</a> section under Applications Information for more details. EN can be connected to IN if not used. |
| NR   | 4                   | Fixed voltage versions only—connecting an external capacitor to this pin bypasses noise generated by the internal bandgap, reducing output noise to very low levels.                                                                                       |
| FB   | 4                   | Adjustable voltage version only—this is the input to the control loop error amplifier, and is used to set the output voltage of the device.                                                                                                                |
| OUT  | 5                   | Output of the Regulator. There are no output capacitor requirements for stability.                                                                                                                                                                         |

**TYPICAL CHARACTERISTICS**

For all voltage versions, at  $T_J = +25^\circ\text{C}$ ,  $V_{IN} = V_{OUT(nom)} + 0.5\text{V}$ ,  $I_{OUT} = 10\text{mA}$ ,  $V_{EN} = 1.7\text{V}$ , and  $C_{OUT} = 0.1\mu\text{F}$ , unless otherwise noted.

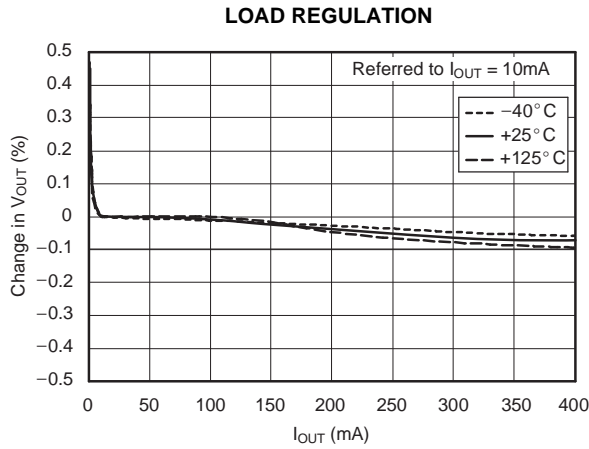

Figure 3.

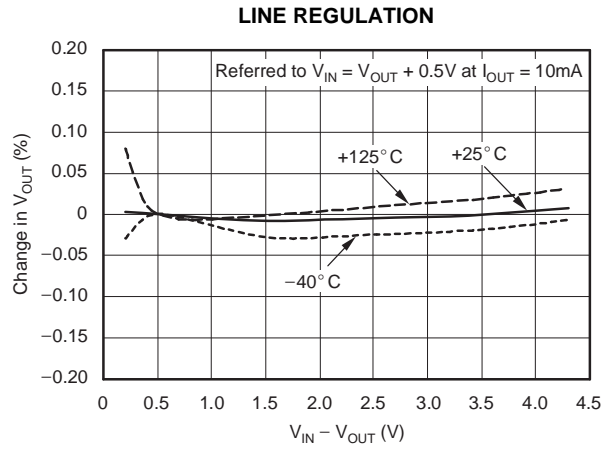

Figure 4.

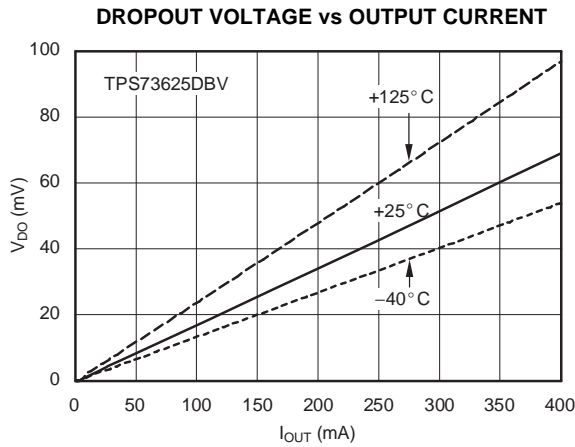

Figure 5.

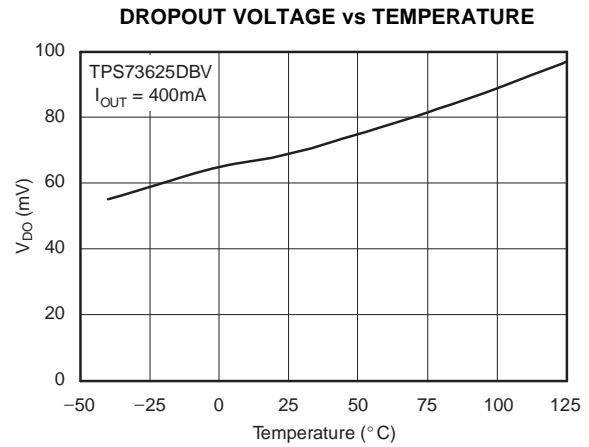

Figure 6.

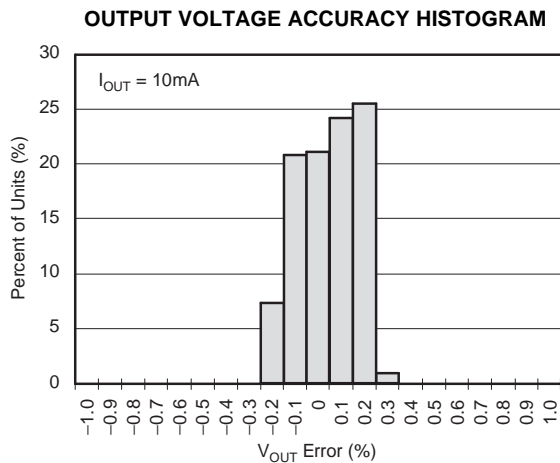

Figure 7.

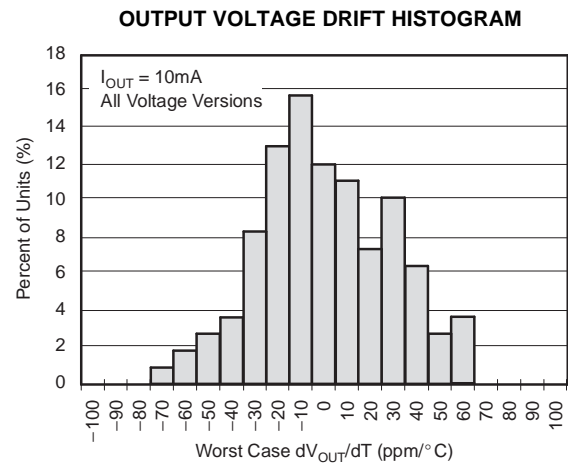

Figure 8.

**TYPICAL CHARACTERISTICS (continued)**

For all voltage versions, at  $T_J = +25^\circ\text{C}$ ,  $V_{IN} = V_{OUT(nom)} + 0.5\text{V}$ ,  $I_{OUT} = 10\text{mA}$ ,  $V_{EN} = 1.7\text{V}$ , and  $C_{OUT} = 0.1\mu\text{F}$ , unless otherwise noted.

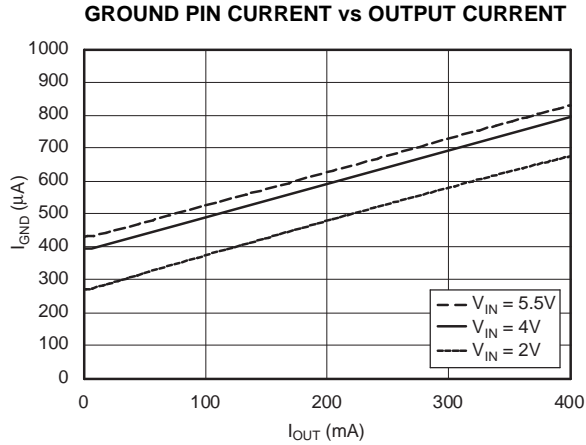

Figure 9.

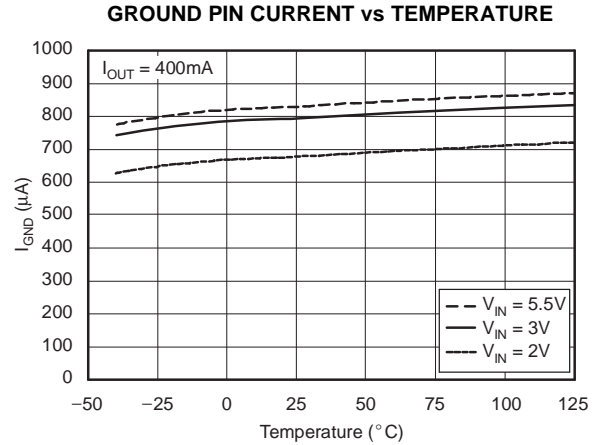

Figure 10.

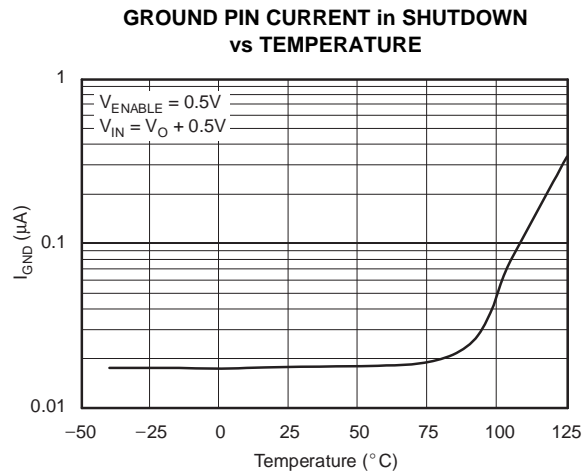

Figure 11.

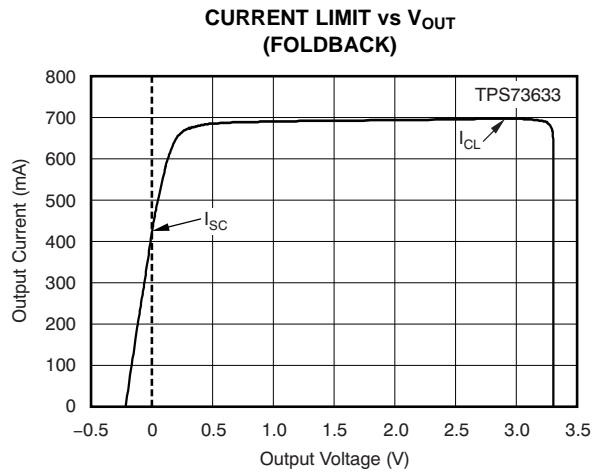

Figure 12.

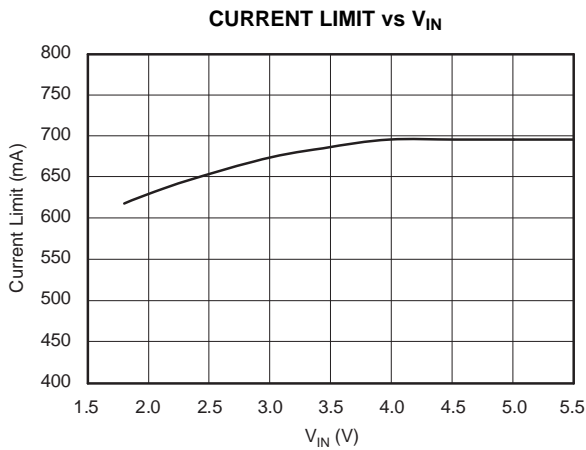

Figure 13.

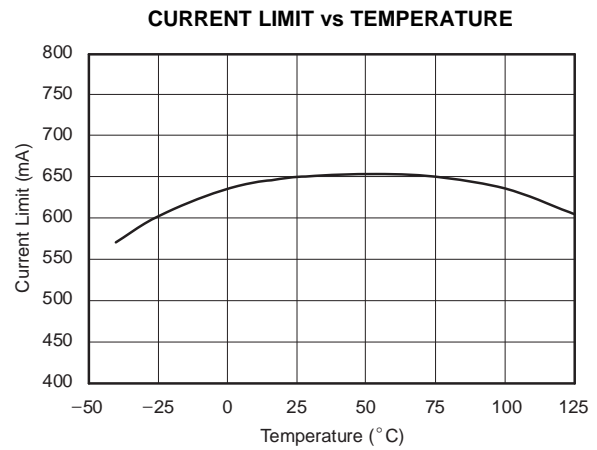

Figure 14.



**TYPICAL CHARACTERISTICS (continued)**

For all voltage versions, at  $T_J = +25^\circ\text{C}$ ,  $V_{IN} = V_{OUT(nom)} + 0.5\text{V}$ ,  $I_{OUT} = 10\text{mA}$ ,  $V_{EN} = 1.7\text{V}$ , and  $C_{OUT} = 0.1\mu\text{F}$ , unless otherwise noted.

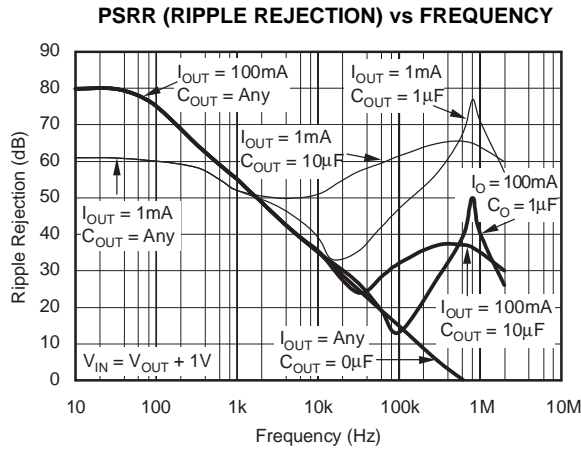

Figure 15.

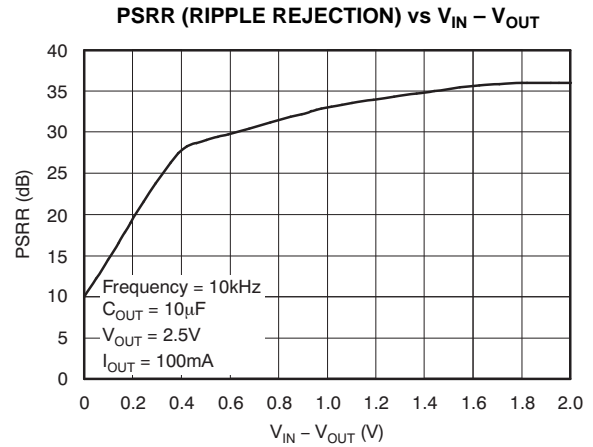

Figure 16.

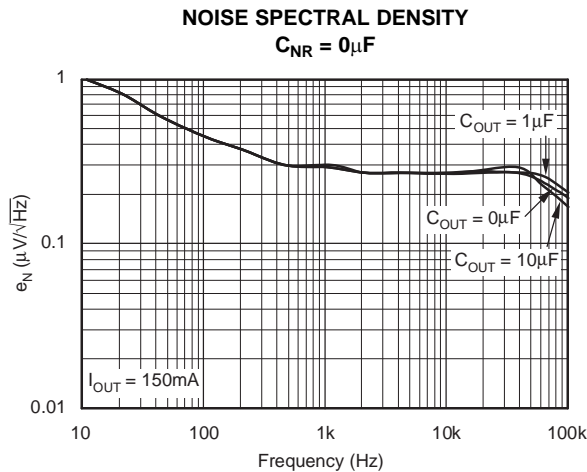

Figure 17.

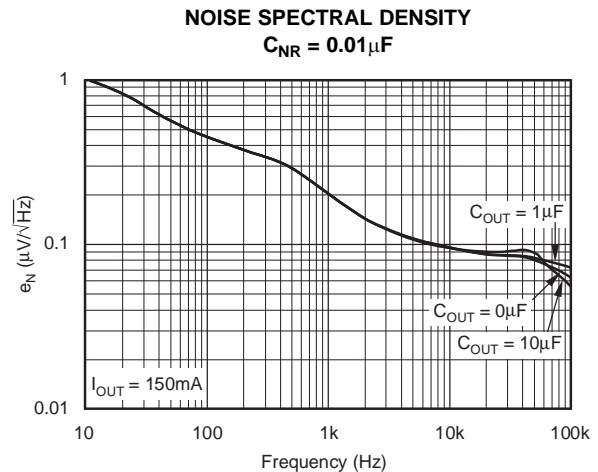

Figure 18.

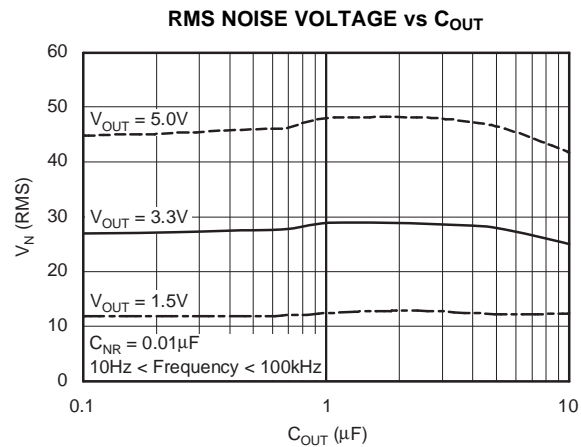

Figure 19.

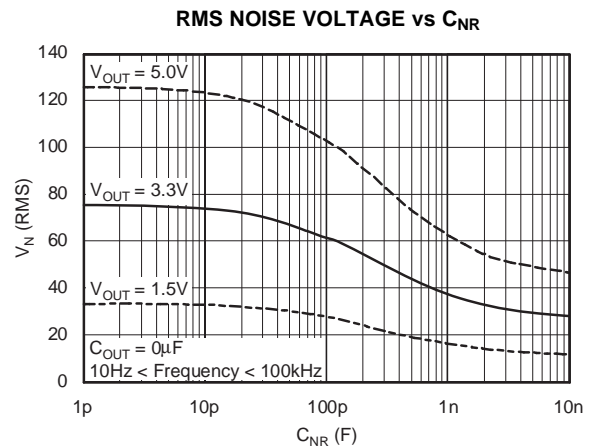

Figure 20.

**TYPICAL CHARACTERISTICS (continued)**

For all voltage versions, at  $T_J = +25^\circ\text{C}$ ,  $V_{IN} = V_{OUT(nom)} + 0.5\text{V}$ ,  $I_{OUT} = 10\text{mA}$ ,  $V_{EN} = 1.7\text{V}$ , and  $C_{OUT} = 0.1\mu\text{F}$ , unless otherwise noted.

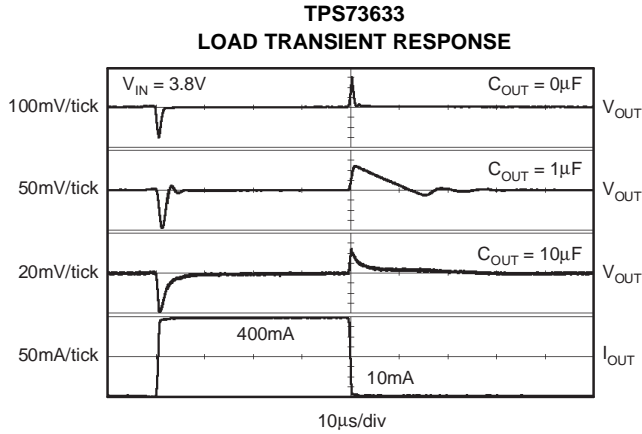

Figure 21.

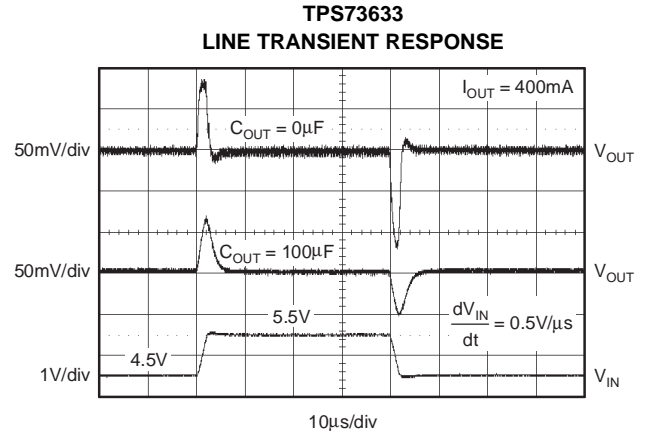

Figure 22.

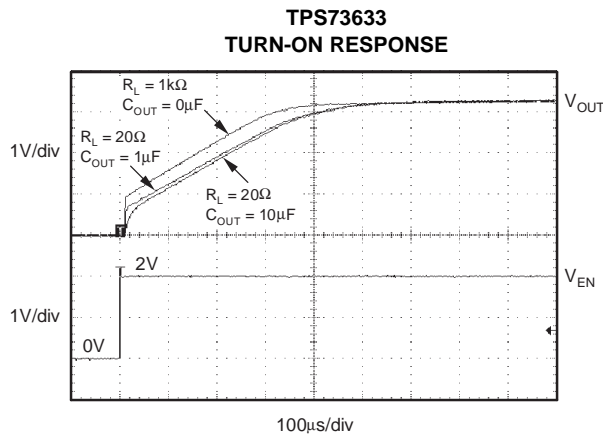

Figure 23.

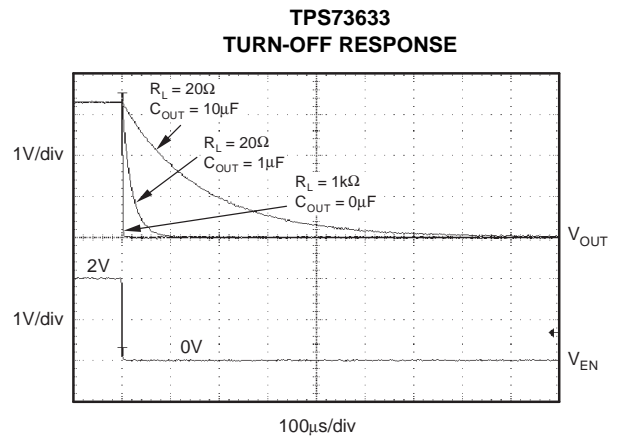

Figure 24.

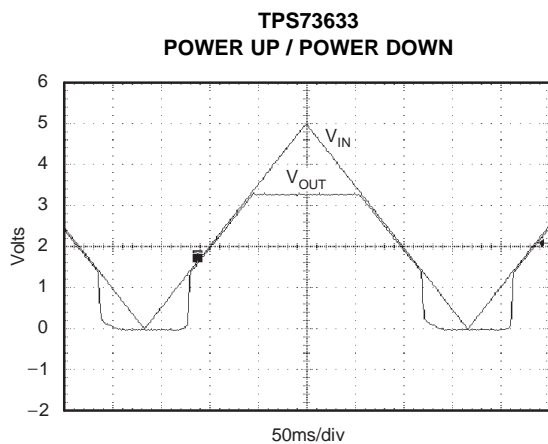

Figure 25.

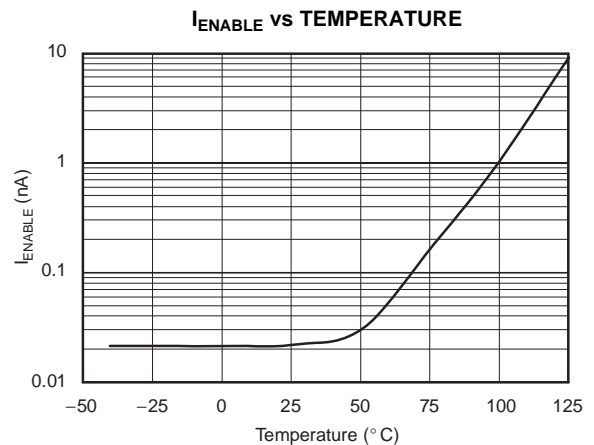

Figure 26.

**TYPICAL CHARACTERISTICS (continued)**

For all voltage versions, at  $T_J = +25^\circ\text{C}$ ,  $V_{IN} = V_{OUT(nom)} + 0.5\text{V}$ ,  $I_{OUT} = 10\text{mA}$ ,  $V_{EN} = 1.7\text{V}$ , and  $C_{OUT} = 0.1\mu\text{F}$ , unless otherwise noted.

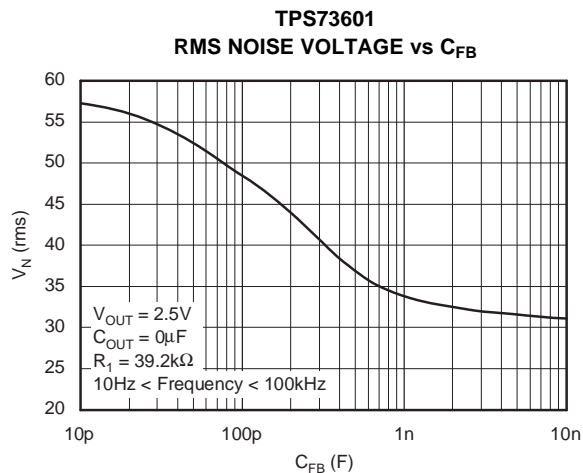

Figure 27.

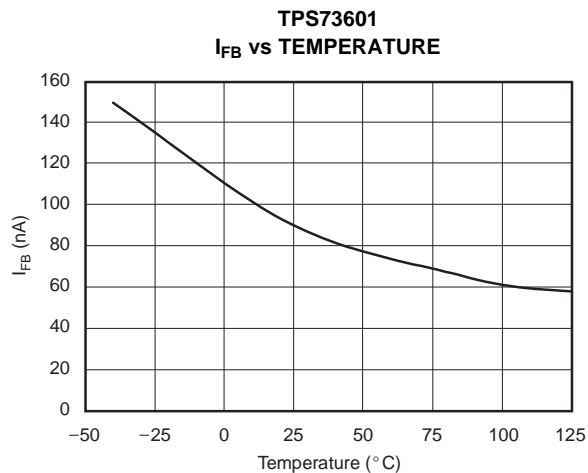

Figure 28.

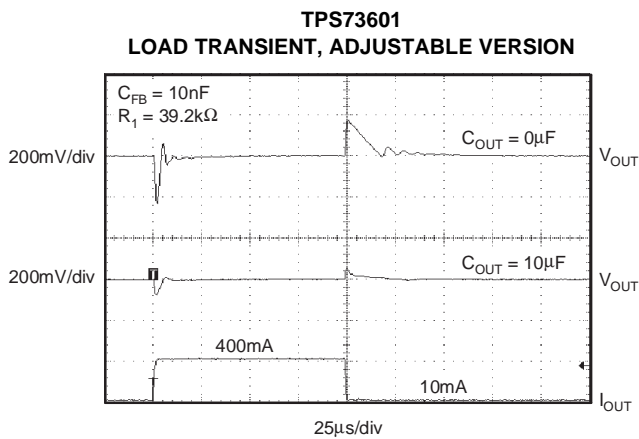

Figure 29.

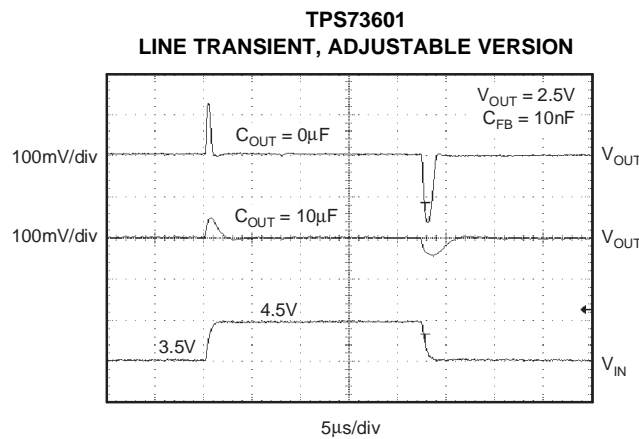

Figure 30.

### APPLICATION INFORMATION

The TPS736xx belongs to a family of new generation LDO regulators that use an NMOS pass transistor to achieve ultra-low-dropout performance, reverse current blockage, and freedom from output capacitor constraints. These features, combined with low noise and an enable input, make the TPS736xx ideal for portable applications. This regulator family offers a wide selection of fixed output voltage versions and an adjustable output version. All versions have thermal and over-current protection, including foldback current limit.

Figure 31 shows the basic circuit connections for the fixed voltage models. Figure 32 gives the connections for the adjustable output version (TPS73601).

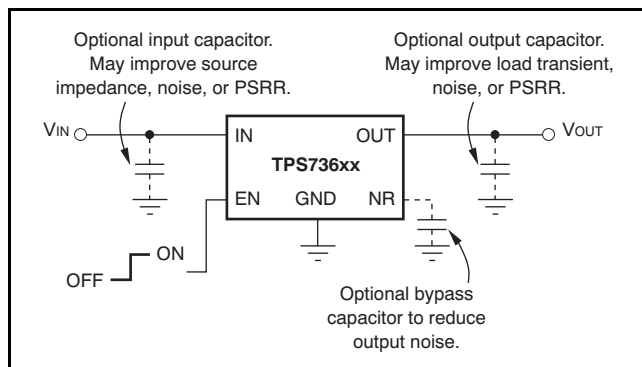

Figure 31. Typical Application Circuit for Fixed-Voltage Versions

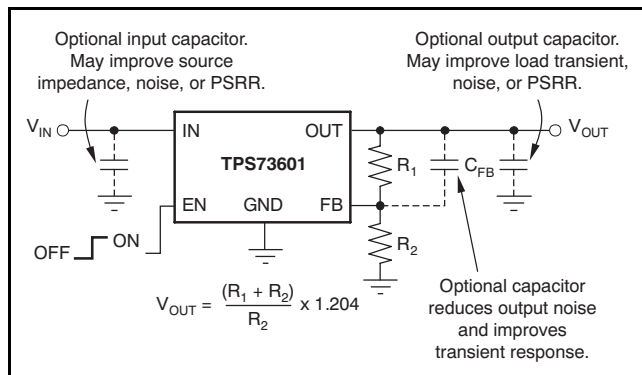

Figure 32. Typical Application Circuit for Adjustable-Voltage Version

$R_1$  and  $R_2$  can be calculated for any output voltage using the formula shown in Figure 32. Sample resistor values for common output voltages are shown in Figure 2.

For best accuracy, make the parallel combination of  $R_1$  and  $R_2$  approximately equal to  $19k\Omega$ . This  $19k\Omega$ , in addition to the internal  $8k\Omega$  resistor, presents the same impedance to the error amp as the  $27k\Omega$  bandgap reference output. This impedance helps compensate for leakages into the error amp terminals.

### INPUT AND OUTPUT CAPACITOR REQUIREMENTS

Although an input capacitor is not required for stability, it is good analog design practice to connect a  $0.1\mu F$  to  $1\mu F$  low ESR capacitor across the input supply near the regulator. This counteracts reactive input sources and improves transient response, noise rejection, and ripple rejection. A higher-value capacitor may be necessary if large, fast rise-time load transients are anticipated or the device is located several inches from the power source.

The TPS736xx does not require an output capacitor for stability and has maximum phase margin with no capacitor. It is designed to be stable for all available types and values of capacitors. In applications where multiple low ESR capacitors are in parallel, ringing may occur when the product of  $C_{OUT}$  and total ESR drops below  $50nF$ . Total ESR includes all parasitic resistances, including capacitor ESR and board, socket, and solder joint resistance. In most applications, the sum of capacitor ESR and trace resistance will meet this requirement.

### OUTPUT NOISE

A precision band-gap reference is used to generate the internal reference voltage,  $V_{REF}$ . This reference is the dominant noise source within the TPS736xx and it generates approximately  $32\mu V_{RMS}$  (10Hz to 100kHz) at the reference output (NR). The regulator control loop gains up the reference noise with the same gain as the reference voltage, so that the noise voltage of the regulator is approximately given by:

$$V_N = 32\mu V_{RMS} \times \frac{(R_1 + R_2)}{R_2} = 32\mu V_{RMS} \times \frac{V_{OUT}}{V_{REF}} \quad (1)$$

Since the value of  $V_{REF}$  is 1.2V, this relationship reduces to:

$$V_N(\mu V_{RMS}) = 27 \left( \frac{\mu V_{RMS}}{V} \right) \times V_{OUT}(V) \quad (2)$$

for the case of no  $C_{NR}$ .

An internal 27kΩ resistor in series with the noise reduction pin (NR) forms a low-pass filter for the voltage reference when an external noise reduction capacitor, C<sub>NR</sub>, is connected from NR to ground. For C<sub>NR</sub> = 10nF, the total noise in the 10Hz to 100kHz bandwidth is reduced by a factor of ~3.2, giving the approximate relationship:

$$V_N(\mu V_{RMS}) = 8.5 \left( \frac{\mu V_{RMS}}{V} \right) \times V_{OUT}(V) \quad (3)$$

for C<sub>NR</sub> = 10nF.

This noise reduction effect is shown as RMS Noise Voltage vs C<sub>NR</sub> in the [Typical Characteristics](#) section.

The TPS73601 adjustable version does not have the NR pin available. However, connecting a feedback capacitor, C<sub>FB</sub>, from the output to the feedback pin (FB) reduces output noise and improves load transient performance.

The TPS736xx uses an internal charge pump to develop an internal supply voltage sufficient to drive the gate of the NMOS pass element above V<sub>OUT</sub>. The charge pump generates ~250μV of switching noise at ~4MHz; however, charge-pump noise contribution is negligible at the output of the regulator for most values of I<sub>OUT</sub> and C<sub>OUT</sub>.

## BOARD LAYOUT RECOMMENDATION TO IMPROVE PSRR AND NOISE PERFORMANCE

To improve ac performance such as PSRR, output noise, and transient response, it is recommended that the board be designed with separate ground planes for V<sub>IN</sub> and V<sub>OUT</sub>, with each ground plane connected only at the GND pin of the device. In addition, the ground connection for the bypass capacitor should connect directly to the GND pin of the device.

## INTERNAL CURRENT LIMIT

The TPS736xx internal current limit helps protect the regulator during fault conditions. Foldback current limit helps to protect the regulator from damage during output short-circuit conditions by reducing current limit when V<sub>OUT</sub> drops below 0.5V. See [Figure 12](#) in the [Typical Characteristics](#) section.

Note from [Figure 12](#) that approximately –0.2V of V<sub>OUT</sub> results in a current limit of 0mA. Therefore, if OUT is forced below –0.2V before EN goes high, the device may not start up. In applications that work with both a positive and negative voltage supply, the TPS736xx should be enabled first.

## ENABLE PIN AND SHUTDOWN

The enable pin (EN) is active high and is compatible with standard TTL-CMOS levels. A V<sub>EN</sub> below 0.5V (max) turns the regulator off and drops the GND pin current to approximately 10nA. When EN is used to shutdown the regulator, all charge is removed from the pass transistor gate, and the output ramps back up to a regulated V<sub>OUT</sub> (see [Figure 23](#)).

When shutdown capability is not required, EN can be connected to V<sub>IN</sub>. However, the pass gate may not be discharged using this configuration, and the pass transistor may be left on (enhanced) for a significant time after V<sub>IN</sub> has been removed. This scenario can result in reverse current flow (if the IN pin is low impedance) and faster ramp times upon power-up. In addition, for V<sub>IN</sub> ramp times slower than a few milliseconds, the output may overshoot upon power-up.

Note that current limit foldback can prevent device start-up under some conditions. See the [Internal Current Limit](#) section for more information.

## DROPOUT VOLTAGE

The TPS736xx uses an NMOS pass transistor to achieve extremely low dropout. When (V<sub>IN</sub> – V<sub>OUT</sub>) is less than the dropout voltage (V<sub>DO</sub>), the NMOS pass device is in its linear region of operation and the input-to-output resistance is the R<sub>DS-ON</sub> of the NMOS pass element.

For large step changes in load current, the TPS736xx requires a larger voltage drop from V<sub>IN</sub> to V<sub>OUT</sub> to avoid degraded transient response. The boundary of this transient dropout region is approximately twice the dc dropout. Values of V<sub>IN</sub> – V<sub>OUT</sub> above this line ensure normal transient response.

Operating in the transient dropout region can cause an increase in recovery time. The time required to recover from a load transient is a function of the magnitude of the change in load current rate, the rate of change in load current, and the available headroom (V<sub>IN</sub> to V<sub>OUT</sub> voltage drop). Under worst-case conditions [full-scale instantaneous load change with (V<sub>IN</sub> – V<sub>OUT</sub>) close to dc dropout levels], the TPS736xx can take a couple of hundred microseconds to return to the specified regulation accuracy.

## TRANSIENT RESPONSE

The low open-loop output impedance provided by the NMOS pass element in a voltage follower configuration allows operation without an output capacitor for many applications. As with any regulator, the addition of a capacitor (nominal value 1 $\mu$ F) from the OUT pin to ground will reduce undershoot magnitude but increase its duration. In the adjustable version, the addition of a capacitor, C<sub>FB</sub>, from the OUT pin to the FB pin will also improve the transient response.

The TPS736xx does not have active pull-down when the output is over-voltage. This allows applications that connect higher voltage sources, such as alternate power supplies, to the output. This also results in an output overshoot of several percent if load current quickly drops to zero when a capacitor is connected to the output. The duration of overshoot can be reduced by adding a load resistor. The overshoot decays at a rate determined by output capacitor C<sub>OUT</sub> and the internal/external load resistance. The rate of decay is given by:

(Fixed Voltage Version)

$$dV/dt = \frac{V_{OUT}}{C_{OUT} \times 80k\Omega \parallel R_{LOAD}} \quad (4)$$

(Adjustable Voltage Version)

$$dV/dt = \frac{V_{OUT}}{C_{OUT} \times 80k\Omega \parallel (R_1 + R_2) \parallel R_{LOAD}} \quad (5)$$

## REVERSE CURRENT

The NMOS pass element of the TPS736xx provides inherent protection against current flow from the output of the regulator to the input when the gate of the pass device is pulled low. To ensure that all charge is removed from the gate of the pass element, the EN pin must be driven low before the input voltage is removed. If this is not done, the pass element may be left on due to stored charge on the gate.

After the EN pin is driven low, no bias voltage is needed on any pin for reverse current blocking. Note that reverse current is specified as the current flowing out of the IN pin due to voltage applied on the OUT pin. There will be additional current flowing into the OUT pin due to the 80k $\Omega$  internal resistor divider to ground (see [Figure 1](#) and [Figure 2](#)).

For the TPS73601, reverse current may flow when V<sub>FB</sub> is more than 1.0V above V<sub>IN</sub>.

## THERMAL PROTECTION

Thermal protection disables the output when the junction temperature rises to approximately +160°C, allowing the device to cool. When the junction temperature cools to approximately +140°C, the output circuitry is again enabled. Depending on power dissipation, thermal resistance, and ambient temperature, the thermal protection circuit may cycle on and off. This limits the dissipation of the regulator, protecting it from damage due to overheating.

Any tendency to activate the thermal protection circuit indicates excessive power dissipation or an inadequate heat sink. For reliable operation, junction temperature should be limited to +125°C maximum. To estimate the margin of safety in a complete design (including heat sink), increase the ambient temperature until the thermal protection is triggered; use worst-case loads and signal conditions. For good reliability, thermal protection should trigger at least +35°C above the maximum expected ambient condition of your application. This produces a worst-case junction temperature of +125°C at the highest expected ambient temperature and worst-case load.

The internal protection circuitry of the TPS736xx has been designed to protect against overload conditions. It was not intended to replace proper heat sinking. Continuously running the TPS736xx into thermal shutdown degrades device reliability.

## POWER DISSIPATION

The ability to remove heat from the die is different for each package type, presenting different considerations in the PCB layout. The PCB area around the device that is free of other components moves the heat from the device to the ambient air. Performance data for JEDEC low- and high-K boards are shown in the [Thermal Information](#) table. Using heavier copper will increase the effectiveness in removing heat from the device. The addition of plated through-holes to heat-dissipating layers will also improve the heat-sink effectiveness.

Power dissipation depends on input voltage and load conditions. Power dissipation ( $P_D$ ) is equal to the product of the output current times the voltage drop across the output pass element ( $V_{IN}$  to  $V_{OUT}$ ):

$$P_D = (V_{IN} - V_{OUT}) \times I_{OUT} \quad (6)$$

Power dissipation can be minimized by using the lowest possible input voltage necessary to assure the required output voltage.

## PACKAGE MOUNTING

Solder pad footprint recommendations for the TPS736xx are presented in Application Bulletin *Solder Pad Recommendations for Surface-Mount Devices* ([SBFA015](#)), available from the Texas Instruments web site at [www.ti.com](http://www.ti.com).



---

**PACKAGING INFORMATION**

| Orderable Device | Status <sup>(1)</sup> | Package Type | Package Drawing | Pins | Package Qty | Eco Plan <sup>(2)</sup>    | Lead/<br>Ball Finish | MSL Peak Temp <sup>(3)</sup> | Samples<br>(Requires Login)          |
|------------------|-----------------------|--------------|-----------------|------|-------------|----------------------------|----------------------|------------------------------|--------------------------------------|
| TPS73601QDBVRQ1  | ACTIVE                | SOT-23       | DBV             | 5    | 3000        | Green (RoHS<br>& no Sb/Br) | CU NIPDAU            | Level-1-260C-UNLIM           | <a href="#">Request Free Samples</a> |

<sup>(1)</sup> The marketing status values are defined as follows:

**ACTIVE:** Product device recommended for new designs.

**LIFEBUY:** TI has announced that the device will be discontinued, and a lifetime-buy period is in effect.

**NRND:** Not recommended for new designs. Device is in production to support existing customers, but TI does not recommend using this part in a new design.

**PREVIEW:** Device has been announced but is not in production. Samples may or may not be available.

**OBSOLETE:** TI has discontinued the production of the device.

<sup>(2)</sup> Eco Plan - The planned eco-friendly classification: Pb-Free (RoHS), Pb-Free (RoHS Exempt), or Green (RoHS & no Sb/Br) - please check <http://www.ti.com/productcontent> for the latest availability information and additional product content details.

**TBD:** The Pb-Free/Green conversion plan has not been defined.

**Pb-Free (RoHS):** TI's terms "Lead-Free" or "Pb-Free" mean semiconductor products that are compatible with the current RoHS requirements for all 6 substances, including the requirement that lead not exceed 0.1% by weight in homogeneous materials. Where designed to be soldered at high temperatures, TI Pb-Free products are suitable for use in specified lead-free processes.

**Pb-Free (RoHS Exempt):** This component has a RoHS exemption for either 1) lead-based flip-chip solder bumps used between the die and package, or 2) lead-based die adhesive used between the die and leadframe. The component is otherwise considered Pb-Free (RoHS compatible) as defined above.

**Green (RoHS & no Sb/Br):** TI defines "Green" to mean Pb-Free (RoHS compatible), and free of Bromine (Br) and Antimony (Sb) based flame retardants (Br or Sb do not exceed 0.1% by weight in homogeneous material)

<sup>(3)</sup> MSL, Peak Temp. -- The Moisture Sensitivity Level rating according to the JEDEC industry standard classifications, and peak solder temperature.

**Important Information and Disclaimer:** The information provided on this page represents TI's knowledge and belief as of the date that it is provided. TI bases its knowledge and belief on information provided by third parties, and makes no representation or warranty as to the accuracy of such information. Efforts are underway to better integrate information from third parties. TI has taken and continues to take reasonable steps to provide representative and accurate information but may not have conducted destructive testing or chemical analysis on incoming materials and chemicals. TI and TI suppliers consider certain information to be proprietary, and thus CAS numbers and other limited information may not be available for release.

In no event shall TI's liability arising out of such information exceed the total purchase price of the TI part(s) at issue in this document sold by TI to Customer on an annual basis.

**OTHER QUALIFIED VERSIONS OF TPS73601-Q1 :**

● Catalog: [TPS73601](#)

● Enhanced Product: [TPS73601-EP](#)

NOTE: Qualified Version Definitions:



- Catalog - TI's standard catalog product
- Enhanced Product - Supports Defense, Aerospace and Medical Applications

**TAPE AND REEL INFORMATION**

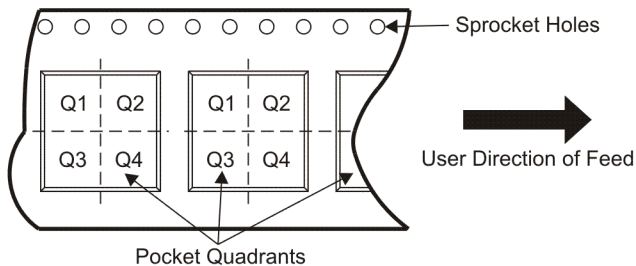
**QUADRANT ASSIGNMENTS FOR PIN 1 ORIENTATION IN TAPE**

\*All dimensions are nominal

| Device          | Package Type | Package Drawing | Pins | SPQ  | Reel Diameter (mm) | Reel Width W1 (mm) | A0 (mm) | B0 (mm) | K0 (mm) | P1 (mm) | W (mm) | Pin1 Quadrant |
|-----------------|--------------|-----------------|------|------|--------------------|--------------------|---------|---------|---------|---------|--------|---------------|
| TPS73601QDBVRQ1 | SOT-23       | DBV             | 5    | 3000 | 179.0              | 8.4                | 3.2     | 3.2     | 1.4     | 4.0     | 8.0    | Q3            |

TAPE AND REEL BOX DIMENSIONS



\*All dimensions are nominal

| Device          | Package Type | Package Drawing | Pins | SPQ  | Length (mm) | Width (mm) | Height (mm) |
|-----------------|--------------|-----------------|------|------|-------------|------------|-------------|
| TPS73601QDBVRQ1 | SOT-23       | DBV             | 5    | 3000 | 203.0       | 203.0      | 35.0        |

DBV (R-PDSO-G5)

PLASTIC SMALL-OUTLINE PACKAGE



- NOTES:
- A. All linear dimensions are in millimeters.
  - B. This drawing is subject to change without notice.
  - C. Body dimensions do not include mold flash or protrusion. Mold flash and protrusion shall not exceed 0.15 per side.
  - D. Falls within JEDEC MO-178 Variation AA.

DBV (R-PDSO-G5)

PLASTIC SMALL OUTLINE



- NOTES:
- A. All linear dimensions are in millimeters.
  - B. This drawing is subject to change without notice.
  - C. Customers should place a note on the circuit board fabrication drawing not to alter the center solder mask defined pad.
  - D. Publication IPC-7351 is recommended for alternate designs.
  - E. Laser cutting apertures with trapezoidal walls and also rounding corners will offer better paste release. Customers should contact their board assembly site for stencil design recommendations. Example stencil design based on a 50% volumetric metal load solder paste. Refer to IPC-7525 for other stencil recommendations.

## IMPORTANT NOTICE

Texas Instruments Incorporated and its subsidiaries (TI) reserve the right to make corrections, modifications, enhancements, improvements, and other changes to its products and services at any time and to discontinue any product or service without notice. Customers should obtain the latest relevant information before placing orders and should verify that such information is current and complete. All products are sold subject to TI's terms and conditions of sale supplied at the time of order acknowledgment.

TI warrants performance of its hardware products to the specifications applicable at the time of sale in accordance with TI's standard warranty. Testing and other quality control techniques are used to the extent TI deems necessary to support this warranty. Except where mandated by government requirements, testing of all parameters of each product is not necessarily performed.

TI assumes no liability for applications assistance or customer product design. Customers are responsible for their products and applications using TI components. To minimize the risks associated with customer products and applications, customers should provide adequate design and operating safeguards.

TI does not warrant or represent that any license, either express or implied, is granted under any TI patent right, copyright, mask work right, or other TI intellectual property right relating to any combination, machine, or process in which TI products or services are used. Information published by TI regarding third-party products or services does not constitute a license from TI to use such products or services or a warranty or endorsement thereof. Use of such information may require a license from a third party under the patents or other intellectual property of the third party, or a license from TI under the patents or other intellectual property of TI.

Reproduction of TI information in TI data books or data sheets is permissible only if reproduction is without alteration and is accompanied by all associated warranties, conditions, limitations, and notices. Reproduction of this information with alteration is an unfair and deceptive business practice. TI is not responsible or liable for such altered documentation. Information of third parties may be subject to additional restrictions.

Resale of TI products or services with statements different from or beyond the parameters stated by TI for that product or service voids all express and any implied warranties for the associated TI product or service and is an unfair and deceptive business practice. TI is not responsible or liable for any such statements.

TI products are not authorized for use in safety-critical applications (such as life support) where a failure of the TI product would reasonably be expected to cause severe personal injury or death, unless officers of the parties have executed an agreement specifically governing such use. Buyers represent that they have all necessary expertise in the safety and regulatory ramifications of their applications, and acknowledge and agree that they are solely responsible for all legal, regulatory and safety-related requirements concerning their products and any use of TI products in such safety-critical applications, notwithstanding any applications-related information or support that may be provided by TI. Further, Buyers must fully indemnify TI and its representatives against any damages arising out of the use of TI products in such safety-critical applications.

TI products are neither designed nor intended for use in military/aerospace applications or environments unless the TI products are specifically designated by TI as military-grade or "enhanced plastic." Only products designated by TI as military-grade meet military specifications. Buyers acknowledge and agree that any such use of TI products which TI has not designated as military-grade is solely at the Buyer's risk, and that they are solely responsible for compliance with all legal and regulatory requirements in connection with such use.

TI products are neither designed nor intended for use in automotive applications or environments unless the specific TI products are designated by TI as compliant with ISO/TS 16949 requirements. Buyers acknowledge and agree that, if they use any non-designated products in automotive applications, TI will not be responsible for any failure to meet such requirements.

Following are URLs where you can obtain information on other Texas Instruments products and application solutions:

### Products

|                             |                                                                    |
|-----------------------------|--------------------------------------------------------------------|
| Audio                       | <a href="http://www.ti.com/audio">www.ti.com/audio</a>             |
| Amplifiers                  | <a href="http://amplifier.ti.com">amplifier.ti.com</a>             |
| Data Converters             | <a href="http://dataconverter.ti.com">dataconverter.ti.com</a>     |
| DLP® Products               | <a href="http://www.dlp.com">www.dlp.com</a>                       |
| DSP                         | <a href="http://dsp.ti.com">dsp.ti.com</a>                         |
| Clocks and Timers           | <a href="http://www.ti.com/clocks">www.ti.com/clocks</a>           |
| Interface                   | <a href="http://interface.ti.com">interface.ti.com</a>             |
| Logic                       | <a href="http://logic.ti.com">logic.ti.com</a>                     |
| Power Mgmt                  | <a href="http://power.ti.com">power.ti.com</a>                     |
| Microcontrollers            | <a href="http://microcontroller.ti.com">microcontroller.ti.com</a> |
| RFID                        | <a href="http://www.ti-rfid.com">www.ti-rfid.com</a>               |
| RF/IF and ZigBee® Solutions | <a href="http://www.ti.com/lprf">www.ti.com/lprf</a>               |

### Applications

|                               |                                                                                          |
|-------------------------------|------------------------------------------------------------------------------------------|
| Communications and Telecom    | <a href="http://www.ti.com/communications">www.ti.com/communications</a>                 |
| Computers and Peripherals     | <a href="http://www.ti.com/computers">www.ti.com/computers</a>                           |
| Consumer Electronics          | <a href="http://www.ti.com/consumer-apps">www.ti.com/consumer-apps</a>                   |
| Energy and Lighting           | <a href="http://www.ti.com/energy">www.ti.com/energy</a>                                 |
| Industrial                    | <a href="http://www.ti.com/industrial">www.ti.com/industrial</a>                         |
| Medical                       | <a href="http://www.ti.com/medical">www.ti.com/medical</a>                               |
| Security                      | <a href="http://www.ti.com/security">www.ti.com/security</a>                             |
| Space, Avionics and Defense   | <a href="http://www.ti.com/space-avionics-defense">www.ti.com/space-avionics-defense</a> |
| Transportation and Automotive | <a href="http://www.ti.com/automotive">www.ti.com/automotive</a>                         |
| Video and Imaging             | <a href="http://www.ti.com/video">www.ti.com/video</a>                                   |
| Wireless                      | <a href="http://www.ti.com/wireless-apps">www.ti.com/wireless-apps</a>                   |

TI E2E Community Home Page

[e2e.ti.com](http://e2e.ti.com)

Mailing Address: Texas Instruments, Post Office Box 655303, Dallas, Texas 75265  
Copyright © 2011, Texas Instruments Incorporated