

5W ZENER DIODES

FEATURES

- VOLTAGE RANGE : 3.9 V to 200 V
- HERMETICALLY SEALED PLASTIC CASE
- HIGH SURGE CAPABILITY : 180 W (8.3 ms) .

DESCRIPTION

5 W Zener diodes.

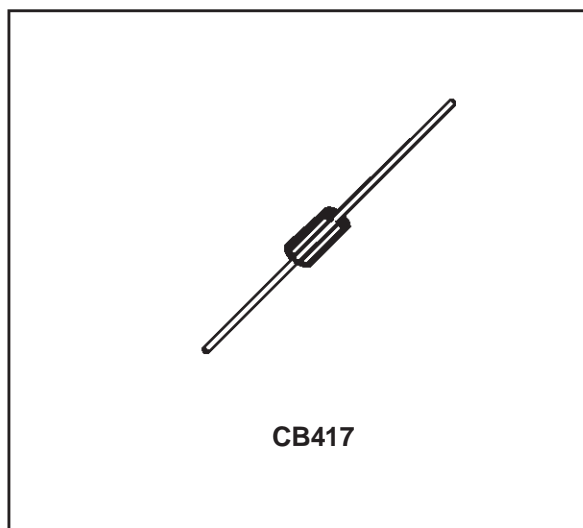

ABSOLUTE RATINGS ($T_{amb} = 25^{\circ}\text{C}$)

Symbol	Parameter		Value	Unit
P	Power dissipation on infinite heatsink	$T_{amb} = 75^{\circ}\text{C}$	5	W
T_{stg} T_j	Storage temperature range Maximum junction temperature		- 65 to + 200 200	$^{\circ}\text{C}$ $^{\circ}\text{C}$
T_L	Maximum lead temperature for soldering during 10s at 5mm from case		230	$^{\circ}\text{C}$

THERMAL RESISTANCES

Symbol	Parameter	Value	Unit
$R_{th(j-a)}$	Junction to lead	25	$^{\circ}\text{C/W}$
$R_{th(j-a)}$	Junction to ambient on printed circuit with recommended pad layout.	75	$^{\circ}\text{C/W}$

1N5335B / 1N5388B

ELECTRICAL CHARACTERISTIC (Tamb= 25°C)

TYPES	V _{ZT} @ I _{ZT} nom.	I _{ZT}	R _{ZT} @ I _{ZT} max.	R _{ZK} @ I _{ZK} max. 1.0mA	I _R @ V _R max.	V _R	αV _Z typ.	I _{ZM} max. T _{amb} =75°C (2)	ΔV _Z max. (3)	I _{ZSM} max. (4)
	(1)	(1)	(1)							
	V	mA	Ω	Ω	μA	V	10 ⁻⁴ /°C	mA	V	A
1N5335B	3.9	320	2.0	500	50	1.0	-5	1220	0.54	18.8
1N5339B	5.6	220	1.0	400	1	2.0	2.5	865	0.25	13.1
1N5342B	6.8	175	1.0	200	10	5.2	4	700	0.15	10.8
1N5344B	8.2	150	1.5	200	10	6.2	4.8	580	0.20	8.9
1N5347B	10	125	2.0	125	5	7.6	5.5	475	0.22	7.3
1N5349B	12	100	2.5	125	2	9.1	6.5	395	0.25	10.1
1N5352B	15	75	2.5	75	1	11.5	7	315	0.25	8.1
1N5355B	18	65	2.5	75	0.5	13.7	7.5	264	0.40	6.7
1N5359B	24	50	3.5	100	0.5	18.2	8	198	0.55	5.0
1N5361B	27	50	5.0	120	0.5	20.6	8.5	176	0.60	4.5
1N5363B	30	40	8.0	140	0.5	22.8	8.5	158	0.60	4.0
1N5365B	36	30	11	160	0.5	27.4	9	132	0.65	3.4
1N5366B	39	30	14	170	0.5	29.7	9	122	0.65	3.1
1N5383B	150	8	330	1500	0.5	114	9.5	31.6	3	0.81
1N5388B	200	5	480	1850	0.5	152	10	23.6	5	0.60

Note 1 : Pulse test : t_p ≤ 50ms δ < 2%

Note 2 : On infinite heatsink : L = 10mm

Note 3 : Measured between 10 % and 50 % of I_{ZM}

Note 4 : rectangular waveform (t_p = 10ms)

Tolerance on nominal V_{ZT} : ± 5 %

Forward voltage drop : V_F ≤ 1.2 V (T_{amb} = 25°C, I_F = 1A)

Fig. 1 : Power dissipation versus ambient temperature.

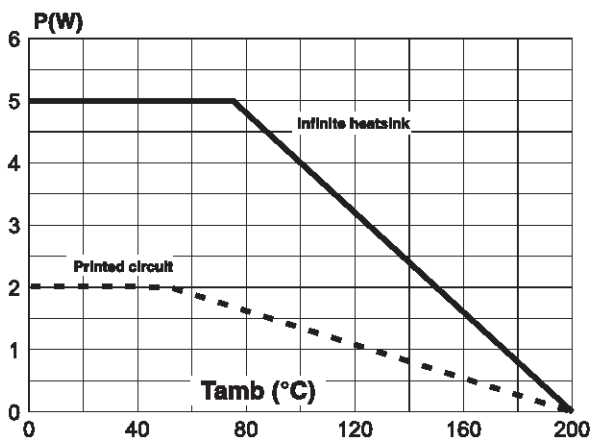

Fig. 2 : Thermal resistance versus lead length.

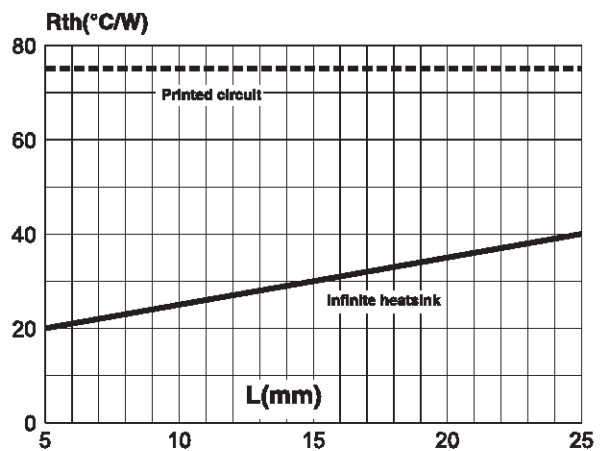

Fig. 3 : Relative variation of thermal impedance junction to ambient versus pulse duration (PC board FR4, $L_{leads} = 10mm$).

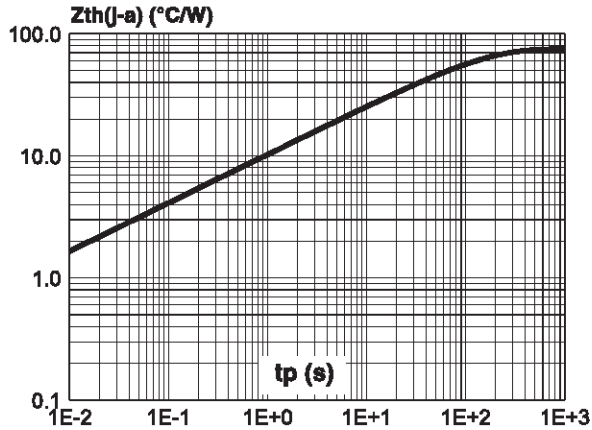

Fig. 5 : Peak forward current versus peak forward voltage drop (typical values).

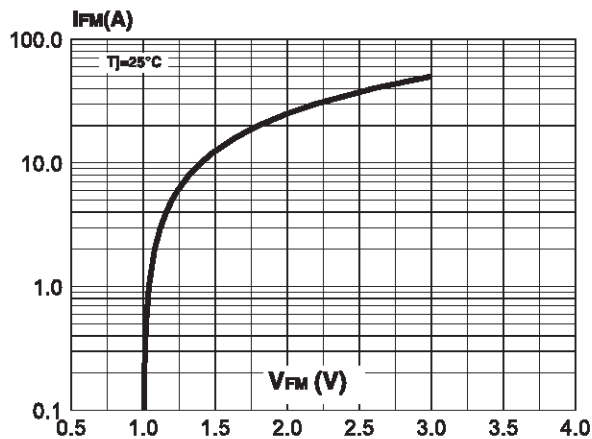

Fig. 7 : Differential resistance versus regulation voltage (typical values).

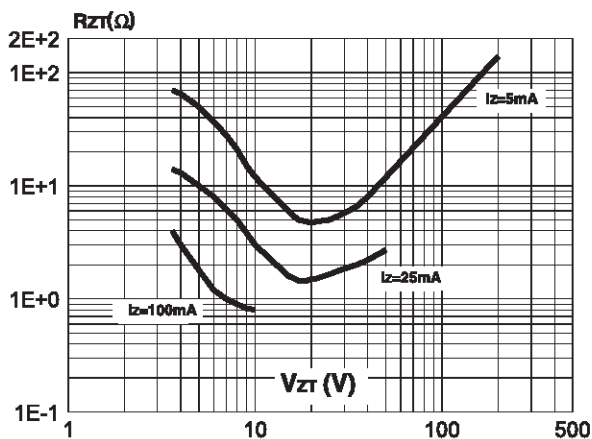

Fig. 4 : Capacitance versus reverse applied voltage.

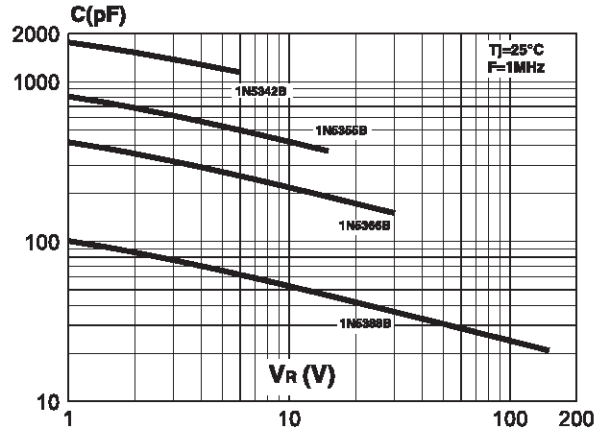

Fig. 6 : Reverse current versus regulation voltage (typical values).

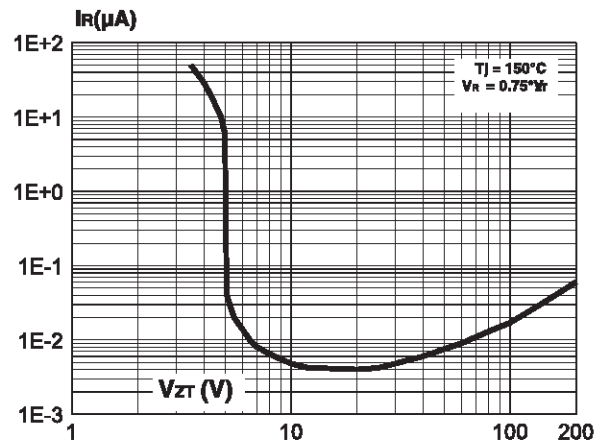
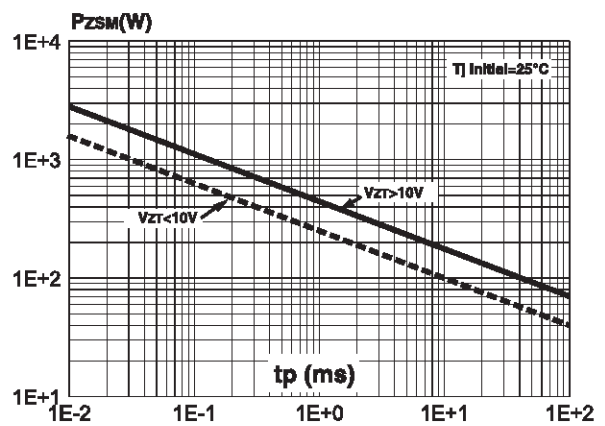

Fig. 8 : Peak pulse power versus pulse duration (rectangular waveform) (maximum values).



1N5335B / 1N5388B

MARKING : Logo, Date Code, Type Code, Cathode Band (for unidirectional types only).

ORDER CODE

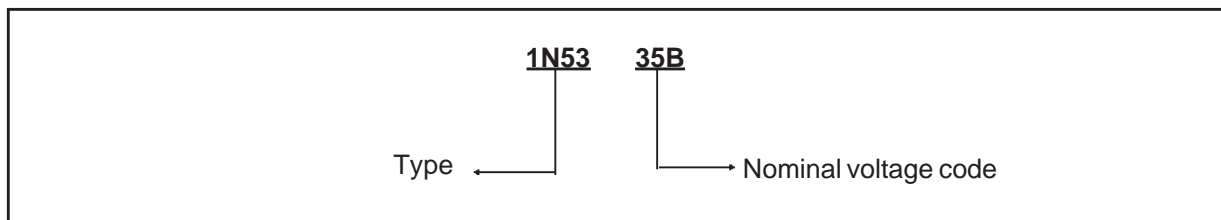

PACKAGE MECHANICAL DATA

CB417 (Plastic)

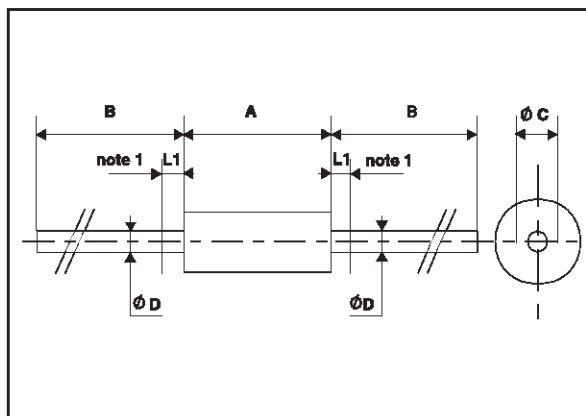

REF.	DIMENSIONS			
	Millimetres		Inches	
	Min.	Max.	Min.	Max.
A		8.89		0.350
B	25.4		1.000	
ØC		3.683		0.145
ØD		1.092		0.043
L1		1.270		0.050

Note 1 : The lead is not controlled within zone L1.

Packaging : standard packaging is in tape and reel.

Weight = 0.65 g.

Information furnished is believed to be accurate and reliable. However, SGS-THOMSON Microelectronics assumes no responsibility for the consequences of use of such information nor for any infringement of patents or other rights of third parties which may result from its use. No license is granted by implication or otherwise under any patent or patent rights of SGS-THOMSON Microelectronics. Specifications mentioned in this publication are subject to change without notice. This publication supersedes and replaces all information previously supplied. SGS-THOMSON Microelectronics products are not authorized for use as critical components in life support devices or systems without express written approval of SGS-THOMSON Microelectronics.

© 1998 SGS-THOMSON Microelectronics - Printed in Italy - All rights reserved.

SGS-THOMSON Microelectronics GROUP OF COMPANIES
 Australia - Brazil - Canada - China - France - Germany - Italy - Japan - Korea - Malaysia - Malta - Morocco
 The Netherlands - Singapore - Spain - Sweden - Switzerland - Taiwan - Thailand - United Kingdom - U.S.A.