

NPN SILICON EPITAXIAL TRANSISTOR
MP-3

DESCRIPTION

2SC2946(1) is designed for High Speed Switching, especially in Hybrid Integrated Circuits.

FEATURES

- High Voltage $V_{CE0} = 200$ V
- High Speed $t_f < 1 \mu s$

QUALITY GRADE

Standard

Please refer to "Quality grade on NEC Semiconductor Devices" (Document number IEI-1209) published by NEC Corporation to know the specification of quality grade on the devices and its recommended applications.

ABSOLUTE MAXIMUM RATINGS ($T_a = 25$ °C)

Collector to Base Voltage	V_{CBO}	330	V
Collector to Emitter Voltage	V_{CEO}	200	V
Emitter to Base Voltage	V_{EBO}	7	V
Collector Current (DC)	I_c	2	A
Collector Current (Pulse)*	I_c	4	A
Total Power Dissipation ($T_a = 25$ °C)**	P_T	2.0	W
Junction Temperature	T_j	150	°C
Storage Temperature	T_{stg}	-55 to +150	°C

* $PW \leq 10$ ms, Duty Cycle ≤ 50 %

** When mounted on ceramic substrate of $7.5 \text{ cm}^2 \times 0.7$ mm

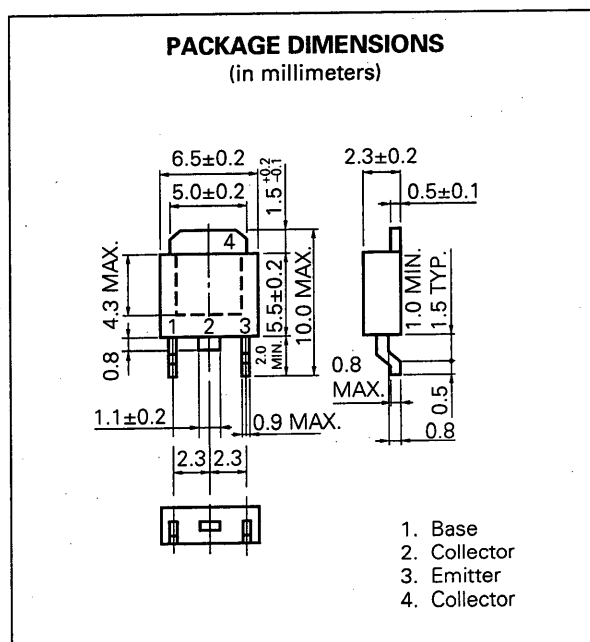
PACKAGE DIMENSIONS
(in millimeters)

ELECTRICAL CHARACTERISTICS (T_a = 25 °C)

CHARACTERISTIC	SYMBOL	MIN.	TYP.	MAX.	UNIT	TEST CONDITIONS
Collector Cutoff Current	I _{CB0}			10	μA	V _{CB} = 250 V, I _E = 0
Emitter Cutoff Current	I _{EB0}			1.0	μA	V _{EB} = 5.0 V, I _C = 0
DC Current Gain	h _{FE1} *	20	60	160		V _{CE} = 5.0 V, I _C = 100 mA
DC Current Gain	h _{FE2} *	15				V _{CE} = 5.0 V, I _C = 1.0 A
Collector Saturation Voltage	V _{CE(sat)} *			1.0	V	I _C = 1.0 A, I _B = 0.1 A
Base Saturation Voltage	V _{BE(sat)} *			1.5	V	I _C = 1.0 A, I _B = 0.1 A
Turn-on Time	t _{on}			1.0	μs	See Test Circuit
Storage Time	t _{stg}			2.0	μs	
Fall Time	t _f			1.0	μs	

* Pulsed: PW ≤ 350 μs, Duty Cycle ≤ 2 %

h_{FE} Classification

MARKING	N	M	L	K
h _{FE1}	20 to 50	30 to 70	50 to 100	80 to 160

SWITCHING TIME (t_{on}, t_{stg}, t_f) TEST CIRCUIT

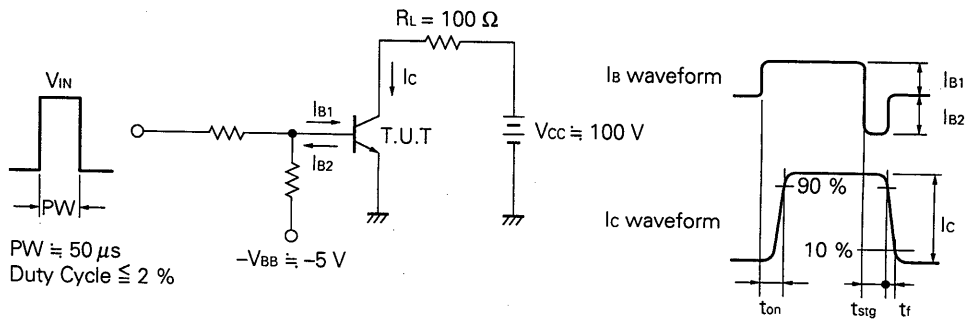

TYPICAL CHARACTERISTICS (T_a = 25 °C)

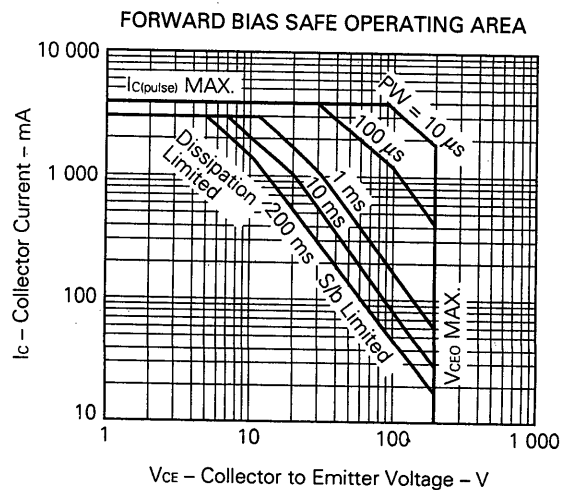
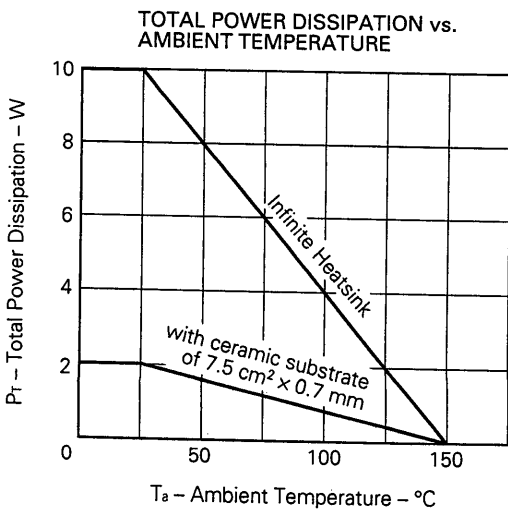

DERATING CURVE OF SAFE OPERATING AREA

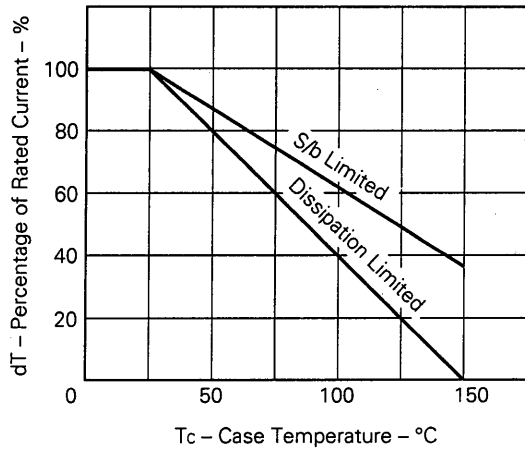

TRANSIENT THERMAL RESISTANCE

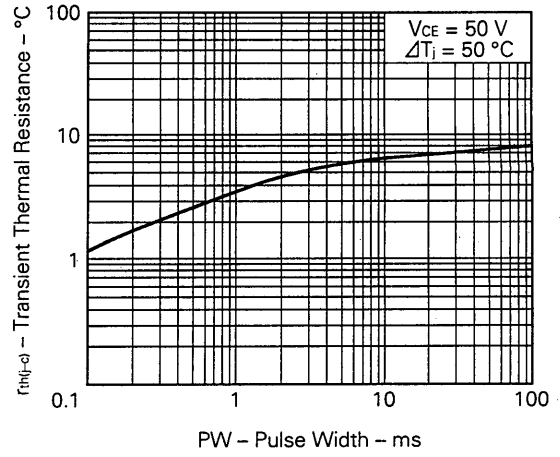

COLLECTOR CURRENT vs. COLLECTOR TO EMITTER VOLTAGE

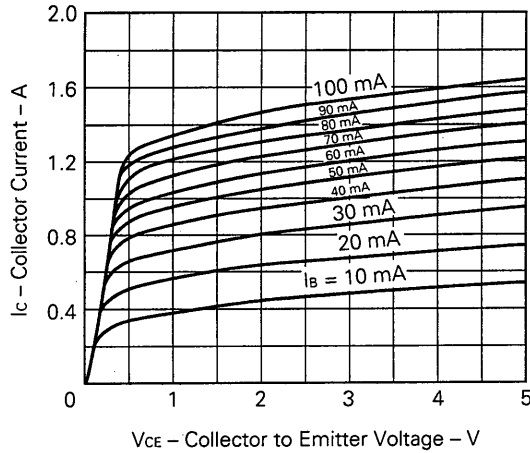

DC CURRENT GAIN vs. COLLECTOR CURRENT

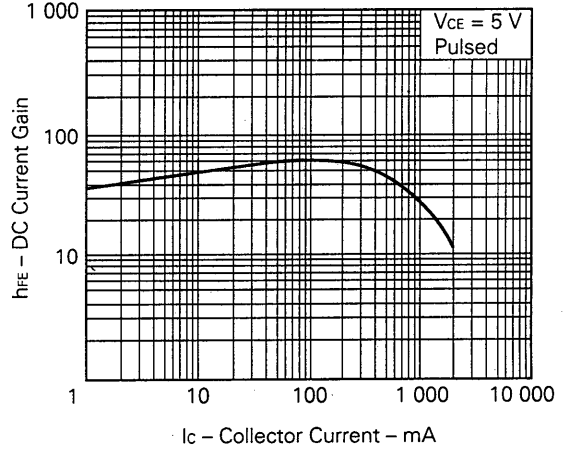

BASE AND COLLECTOR SATURATION VOLTAGE vs. COLLECTOR CURRENT

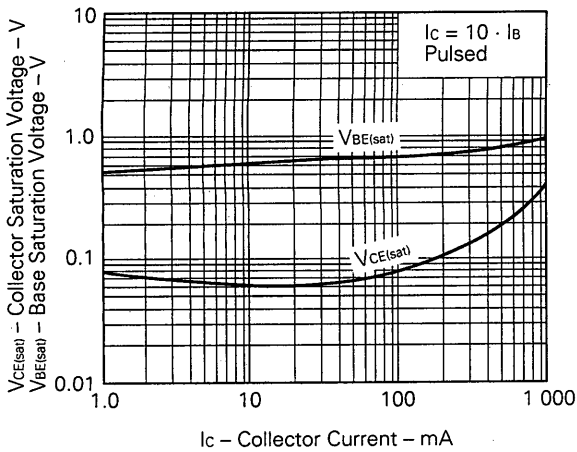

TURN ON TIME, STORAGE TIME AND FALL TIME vs. COLLECTOR CURRENT

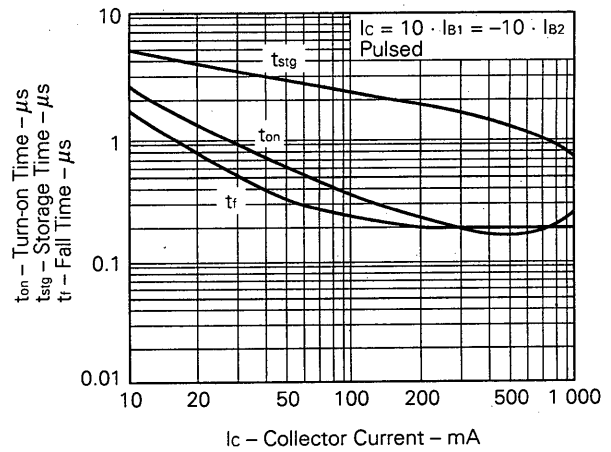

Reference

Application note name	No.
Quality control of NEC semiconductors devices.	TEI-1202
Quality control guide of semiconductors devices.	MEI-1202
Assembly manual of semiconductors devices.	IEI-1207
Design of Push-Pull Type Switching Regulators (Basic)	TEB-1002
Design of Push-Pull Type Switching Regulators (Applications)	TEB-1003
Optimum Base Drive Conditions of Switching Power Transistors	TEB-1014

No part of this document may be copied or reproduced in any form or by any means without the prior written consent of NEC Corporation. NEC Corporation assumes no responsibility for any errors which may appear in this document.

NEC Corporation does not assume any liability for infringement of patents, copyrights or other intellectual property rights of third parties by or arising from use of a device described herein or any other liability arising from use of such device. No license, either express, implied or otherwise, is granted under any patents, copyrights or other intellectual property rights of NEC Corporation or others.

The devices listed in this document are not suitable for use in aerospace equipment, submarine cables, nuclear reactor control systems and life support systems. If customers intend to use NEC devices for above applications or they intend to use "Standard" quality grade NEC devices for applications not intended by NEC, please contact our sales people in advance.

Application examples recommended by NEC Corporation.

Standard: Computer, Office equipment, Communication equipment, Test and Measurement equipment, Machine tools, Industrial robots, Audio and Visual equipment, Other consumer products, etc.

Special: Automotive and Transportation equipment, Traffic control systems, Antidisaster systems, Anticrime systems, etc.