

HIGH VOLTAGE, HIGH CURRENT SWITCH

DESCRIPTION

The BUY47 and BUY48 are silicon epitaxial planar NPN transistors in Jedec TO-39 metal case. They are used in high-voltage, high-current switching applications up to 7 A.

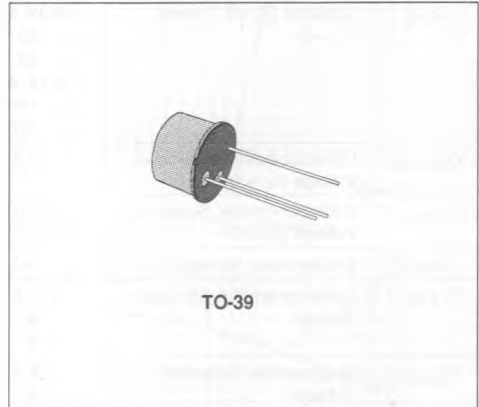

INTERNAL SCHEMATIC DIAGRAM

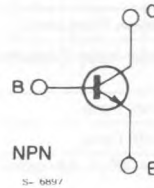

ABSOLUTE MAXIMUM RATINGS

Symbol	Parameter	Value		Unit
		BUY 47	BUY 48	
V_{CBO}	Collector-base Voltage ($I_E = 0$)	150	200	V
V_{CEO}	Collector-emitter Voltage ($I_B = 0$)	120	170	V
V_{EBO}	Emitter-base Voltage ($I_C = 0$)	6		V
I_C	Collector Current	7		A
I_{CM}	Collector Peak Current (repetitive)	10		A
P_{Tot}	Total Power Dissipation at $T_{amb} \leq 25^\circ\text{C}$ $T_{case} \leq 50^\circ\text{C}$	1		W
		10		W
T_{stg}	Storage Temperature	- 65 to 200		$^\circ\text{C}$
T_j	Junction Temperature	200		$^\circ\text{C}$

THERMAL DATA

$R_{th\ j-case}$	Thermal Resistance Junction-case	Max	15	°C/W
$R_{th\ j-amb}$	Thermal Resistance Junction-ambient	Max	175	°C/W

ELECTRICAL CHARACTERISTICS ($T_{case} = 25\text{ °C}$ unless otherwise specified)

Symbol	Parameter	Test Conditions	Min.	Typ.	Max.	Unit
I_{CBO}	Collector Cutoff Current ($I_E = 0$)	for BUY 47 $V_{CB} = 80\text{ V}$ $V_{CB} = 80\text{ V}$ for BUY 48 $V_{CB} = 100\text{ V}$ $V_{CB} = 100\text{ V}$ $T_{case} = 125\text{ °C}$			10 1	μA mA
$V_{(BR)CBO}^*$	Collector-base Breakdown Voltage ($I_E = 0$)	$I_C = 1\text{ mA}$ for BUY 47 for BUY 48	150 200			V
$V_{CE0(sus)}^*$	Collector-emitter Sustaining Voltage ($I_B = 0$)	$I_C = 20\text{ mA}$ for BUY 47 for BUY 48	120 170			V
V_{EBO}^*	Emitter-base Voltage ($I_C = 0$)	$I_E = 1\text{ mA}$	6			V
$V_{CE(sat)}^*$	Collector-emitter Saturation Voltage	$I_C = 0.5\text{ A}$ $I_B = 50\text{ mA}$ $I_C = 2\text{ A}$ $I_B = 0.2\text{ A}$ $I_C = 5\text{ A}$ $I_B = 0.5\text{ A}$		0.05	0.45 1	V
$V_{BE(sat)}^*$	Base-emitter Saturation Voltage	$I_C = 0.5\text{ A}$ $I_B = 50\text{ mA}$ $I_C = 2\text{ A}$ $I_B = 0.2\text{ A}$ $I_C = 5\text{ A}$ $I_B = 0.5\text{ A}$		0.8	1.1 1.5	V
h_{FE}^*	DC Current Gain	$I_C = 50\text{ mA}$ $V_{CE} = 5\text{ V}$ $I_C = 0.5\text{ A}$ $V_{CE} = 5\text{ V}$ $I_C = 2\text{ A}$ $V_{CE} = 5\text{ V}$ $I_C = 5\text{ A}$ $V_{CE} = 5\text{ V}$	40 40 15	130 150 130 45		
f_T	Transition Frequency	$I_C = 100\text{ mA}$ $V_{CE} = 10\text{ V}$		90		MHz
C_{CBO}	Collector-base Capacitance	$I_E = 0$ $V_{CB} = 50\text{ V}$ $f = 1\text{ MHz}$		45	80	pF
t_{on}	Turn-on Time	$I_C = 5\text{ A}$ $V_{CC} = 40\text{ V}$			1	μs
t_{off}	Turn-off Time	$I_{B1} = -I_{B2} = 0.5\text{ A}$			2	μs

* Pulsed : pulse duration = 300 μs , duty cycle = 1.5 %.

Safe Operating Areas.

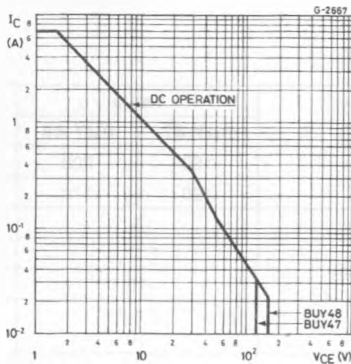

DC Current Gain.

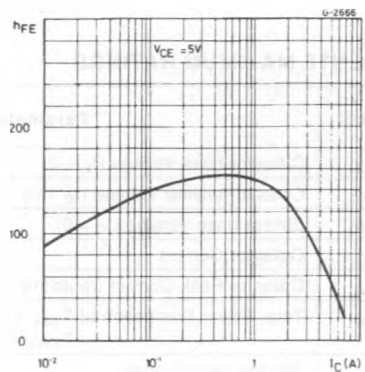

Collector-emitter Saturation Voltage.

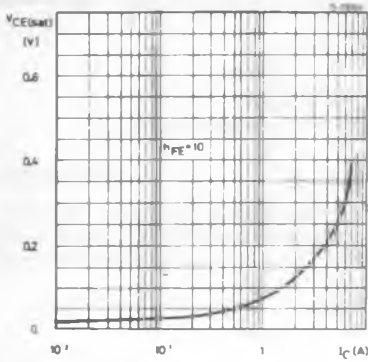

Base-emitter Saturation Voltage.

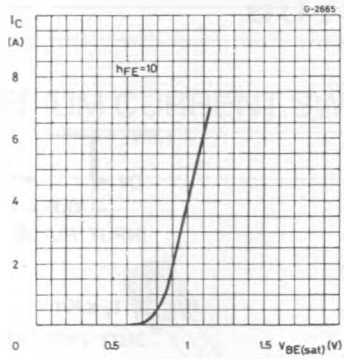

Collector-base Capacitance.

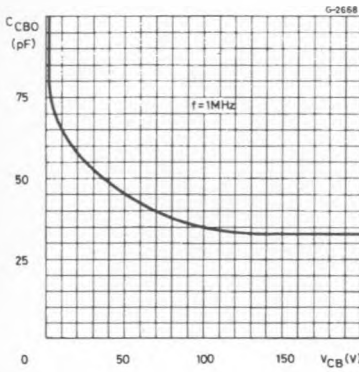

Saturated Switching Characteristics.

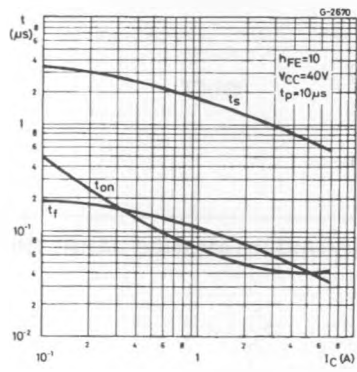

Power Rating Chart.

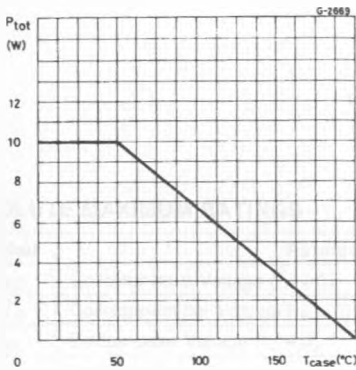

Switching Time Test Circuit.

