



FC11

N-Channel Junction Silicon FET Low-Frequency General-Purpose Amp, Differential Amp Applications

Features

- Adoption of FBET process.
- Composite type with 2 transistors contained in the CP package currently in use, improving the mounting efficiency greatly.
- The FC11 is formed with two chips, being equivalent to the 2SK771, placed in one package.
- Excellent in the thermal equilibrium and pair capability and suitable for use in differential amp.
- Common source.

Electrical Connection

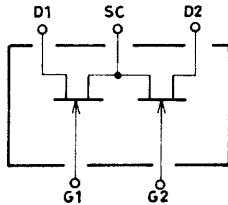

Package Dimensions

unit:mm
2070

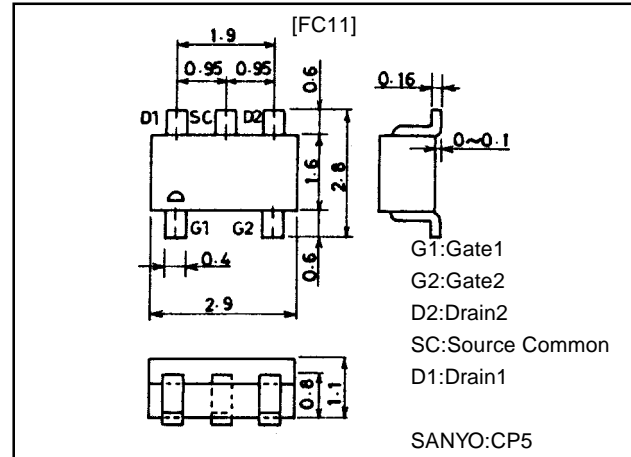

Specifications

Absolute Maximum Ratings at Ta = 25°C

Parameter	Symbol	Conditions	Ratings	Unit
Drain-to-Source Voltage	V_{DSX}		40	V
Gate-to-Drain Voltage	V_{GDS}		-40	V
Gate Current	I_G		10	mA
Drain Current	I_D		10	mA
Allowable Power Dissipation	P_D	1unit	200	mW
Total Dissipation	P_T		300	mW
Junction Temperature	T_J		150	°C
Storage Temperature	T_{stg}		-55 to +150	°C

Electrical Characteristics at Ta = 25°C

Parameter	Symbol	Conditions	Ratings			Unit
			min	typ	max	
Gate-to-Drain Breakdown Voltage	$V_{(BR)GDS}$	$I_G=10\mu A, V_{DS}=0$	-40			V
Gate Cutoff Current	I_{GSS}	$V_{GS}=-20V, V_{DS}=0V$			-1.0	nA
Cutoff Voltage	$V_{GS(off)}$	$V_{DS}=10V, I_D=1\mu A$	-0.3	-0.9	-1.8	V
Gate-to-Source Voltage Drop	ΔV_{GS}	$ V_{GS \text{ large}} - V_{GS \text{ small}} , V_{DS}=10V, I_D=1mA$			30	mV
Drain Current	I_{DSS}	$V_{DS}=10V, V_{GS}=0V$	1.2*		6.0*	mA
Drain Current Ratio		$V_{DS}=10V, I_{DSS \text{ small}}/I_{DSS \text{ large}}$	0.9			
Forward Transfer Admittance	$ Y_{fs} $	$V_{DS}=10V, V_{GS}=0V, f=1kHz$	4.5	9.0		mS
Forward Transfer Admittance Ratio		$V_{DS}=10V, Y_{fs} _{\text{small}} / Y_{fs} _{\text{large}}$	0.9			
Input Capacitance	C_{iss}	$V_{DS}=10V, V_{GS}=0V, f=1MHz$		9.0		pF
Reverse Transfer Capacitance	C_{rss}	$V_{DS}=10V, V_{GS}=0V, f=1MHz$		2.1		pF
Noise Figure	NF	$V_{DS}=10V, R_G=1k\Omega, I_D=1mA, f=1kHz$		1.5		dB

Note*:The FC11 is classified by I_{DSS} as follows (unit:mA)

1.2	D	3.0	2.5	E	6.0
-----	---	-----	-----	---	-----

Marking:11

I_{DSS} rank:D,E

The Specifications shown above are for each individual transistor.

SANYO Electric Co.,Ltd. Semiconductor Business Headquarters

TOKYO OFFICE Tokyo Bldg., 1-10, 1 Chome, Ueno, Taito-ku, TOKYO, 110-8534 JAPAN

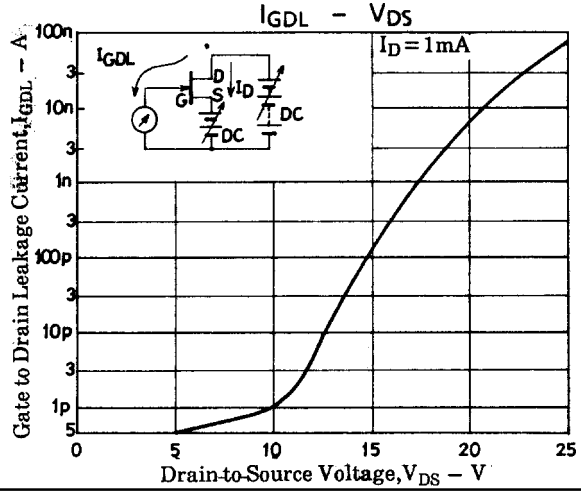
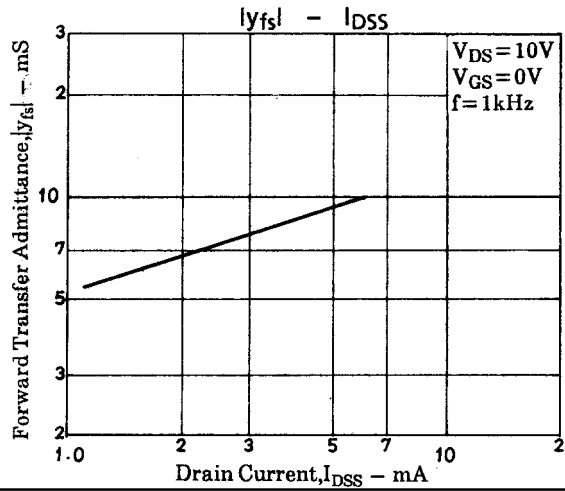
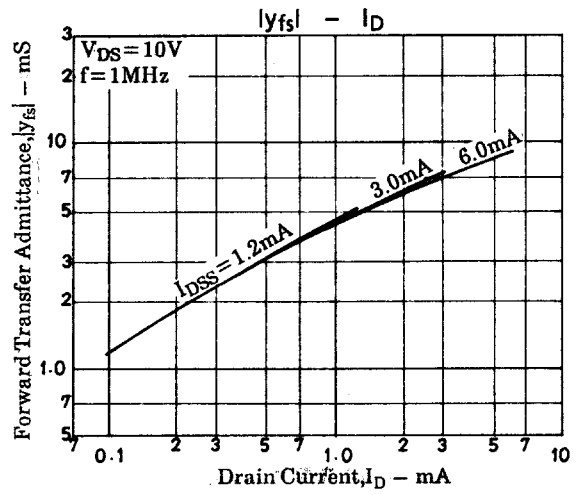
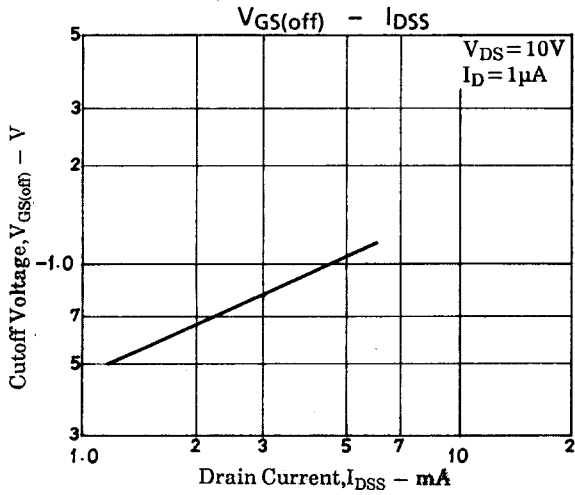
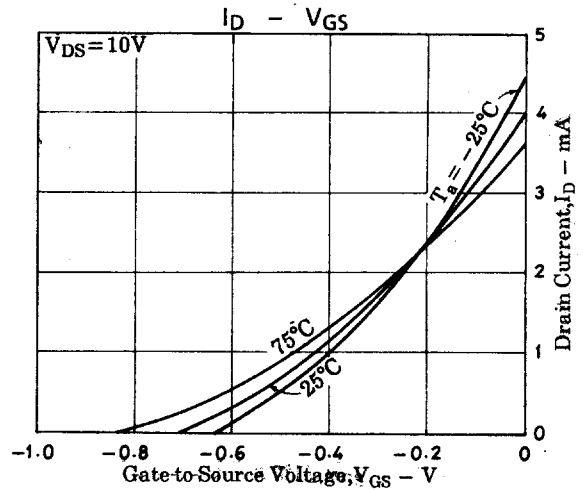
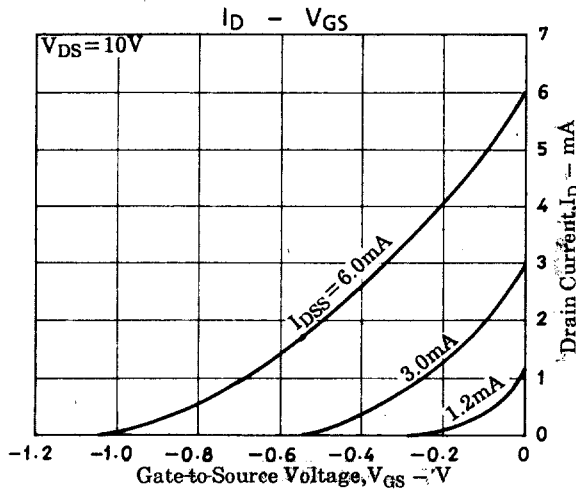
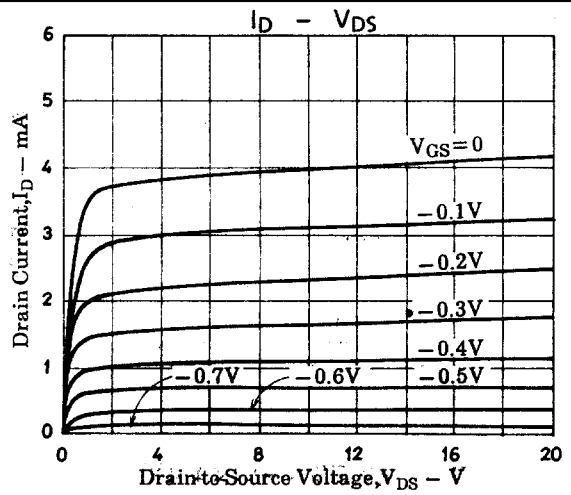
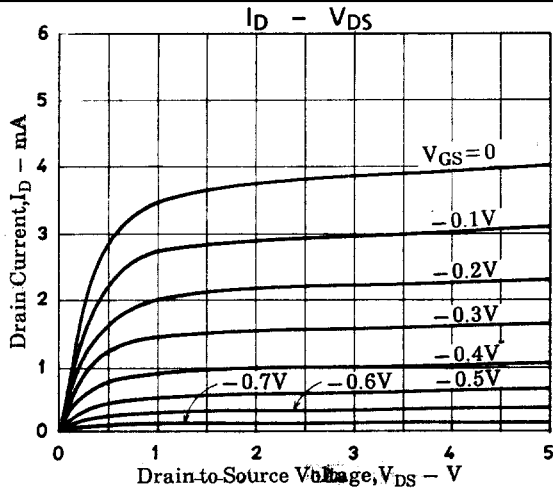

FC11

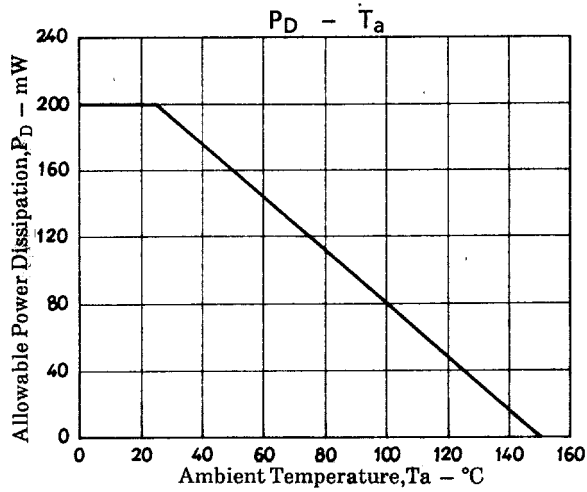
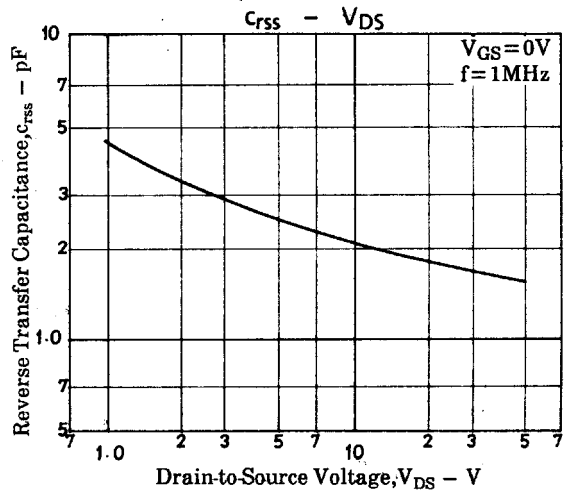
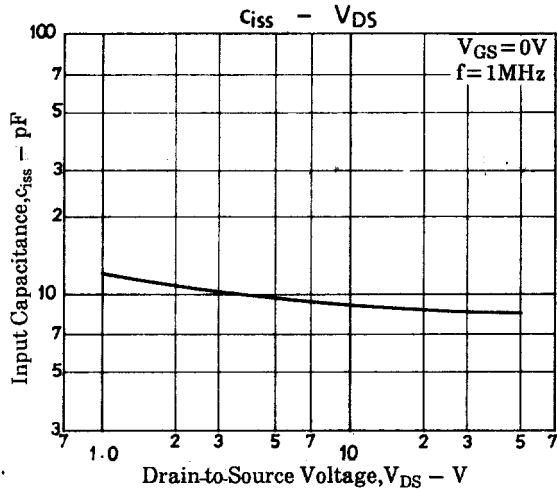

- No products described or contained herein are intended for use in surgical implants, life-support systems, aerospace equipment, nuclear power control systems, vehicles, disaster/crime-prevention equipment and the like, the failure of which may directly or indirectly cause injury, death or property loss.
- Anyone purchasing any products described or contained herein for an above-mentioned use shall:
 - ① Accept full responsibility and indemnify and defend SANYO ELECTRIC CO., LTD., its affiliates, subsidiaries and distributors and all their officers and employees, jointly and severally, against any and all claims and litigation and all damages, cost and expenses associated with such use:
 - ② Not impose any responsibility for any fault or negligence which may be cited in any such claim or litigation on SANYO ELECTRIC CO., LTD., its affiliates, subsidiaries and distributors or any of their officers and employees jointly or severally.
- Information (including circuit diagrams and circuit parameters) herein is for example only; it is not guaranteed for volume production. SANYO believes information herein is accurate and reliable, but no guarantees are made or implied regarding its use or any infringements of intellectual property rights or other rights of third parties.

This catalog provides information as of May, 1998. Specifications and information herein are subject to change without notice.