

The RF Line NPN Silicon High-Frequency Transistor

... designed for UHF linear and large-signal amplifier applications.

- Specified 12.5 Volt, 870 MHz Characteristics —
Output Power = 0.5 Watts
Minimum Gain = 8.0 dB
Efficiency 50%
- S Parameter Data From 250 MHz to 1.5 GHz
- 1.0 dB Compression > +20 dBm Typ
- Ideally Suited for Broadband, Class A, Low-Noise Applications
- Circuit board photomaster available upon request by contacting RF Tactical Marketing in Phoenix, AZ.

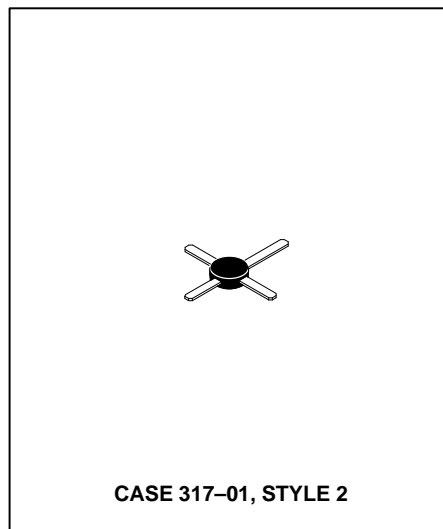
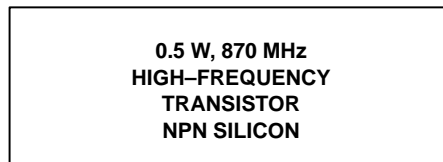

MAXIMUM RATINGS

Rating	Symbol	Value	Unit
Collector-Emitter Voltage	V_{CEO}	16	Vdc
Collector-Base Voltage	V_{CBO}	36	Vdc
Emitter-Base Voltage	V_{EBO}	3.0	Vdc
Collector Current — Continuous	I_C	150	mAdc
Total Device Dissipation @ $T_C = 50^\circ\text{C}$ Derate above 50°C	P_D	2.0 20	Watts mW/ $^\circ\text{C}$
Storage Temperature Range	T_{stg}	-65 to +150	$^\circ\text{C}$

ELECTRICAL CHARACTERISTICS ($T_C = 25^\circ\text{C}$ unless otherwise noted.)

Characteristic	Symbol	Min	Typ	Max	Unit
----------------	--------	-----	-----	-----	------

OFF CHARACTERISTICS

Collector-Emitter Breakdown Voltage ($I_C = 5.0 \text{ mAdc}$, $I_B = 0$)	$V_{(BR)CEO}$	16	—	—	Vdc
Collector-Base Breakdown Voltage ($I_C = 100 \mu\text{Adc}$, $I_E = 0$)	$V_{(BR)CBO}$	36	—	—	Vdc
Emitter-Base Breakdown Voltage ($I_E = 100 \mu\text{Adc}$, $I_C = 0$)	$V_{(BR)EBO}$	3.0	—	—	Vdc
Collector Cutoff Current ($V_{CE} = 15 \text{ Vdc}$, $V_{BE} = 0$)	I_{CES}	—	—	1.0	mAdc

ON CHARACTERISTICS

DC Current Gain ($I_C = 50 \text{ mAdc}$, $V_{CE} = 10 \text{ Vdc}$)	h_{FE}	30	90	200	—
--	----------	----	----	-----	---

DYNAMIC CHARACTERISTICS

Current-Gain — Bandwidth Product ($I_C = 100 \text{ mAdc}$, $V_{CE} = 10 \text{ Vdc}$, $f = 200 \text{ MHz}$)	f_T	—	3000	—	MHz
Output Capacitance ($V_{CB} = 12.5 \text{ Vdc}$, $I_E = 0$, $f = 1.0 \text{ MHz}$)	C_{ob}	—	2.0	2.5	pF

(continued)

ELECTRICAL CHARACTERISTICS — continued ($T_C = 25^\circ\text{C}$ unless otherwise noted.)

Characteristic		Symbol	Min	Typ	Max	Unit
FUNCTIONAL TESTS						
Common-Emitter Amplifier Power Gain ($V_{CC} = 12.5\text{ Vdc}$, $P_{Out} = 0.5\text{ W}$)	$f = 870\text{ MHz}$	G_{PE}	8.0	9.5	—	dB
	$f = 512\text{ MHz}$		—	13	—	
Collector Efficiency ($V_{CC} = 12.5\text{ Vdc}$, $P_{Out} = 0.5\text{ W}$)	$f = 870\text{ MHz}$	η	50	65	—	%
	$f = 512\text{ MHz}$		—	60	—	

TYPICAL PERFORMANCE @ $V_{CC} = 7.5\text{ V}$

Common-Emitter Amplifier Power Gain ($V_{CC} = 7.5\text{ Vdc}$, $P_{Out} = 0.5\text{ W}$)	$f = 870\text{ MHz}$	G_{PE}	—	6.5	—	dB
	$f = 512\text{ MHz}$		—	10	—	
Collector Efficiency ($V_{CC} = 7.5\text{ Vdc}$, $P_{Out} = 0.5\text{ W}$)	$f = 870\text{ MHz}$	η	—	70	—	%
	$f = 512\text{ MHz}$		—	65	—	

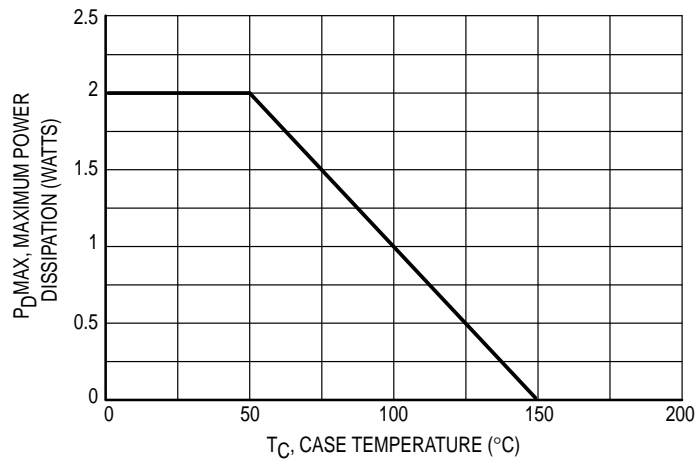
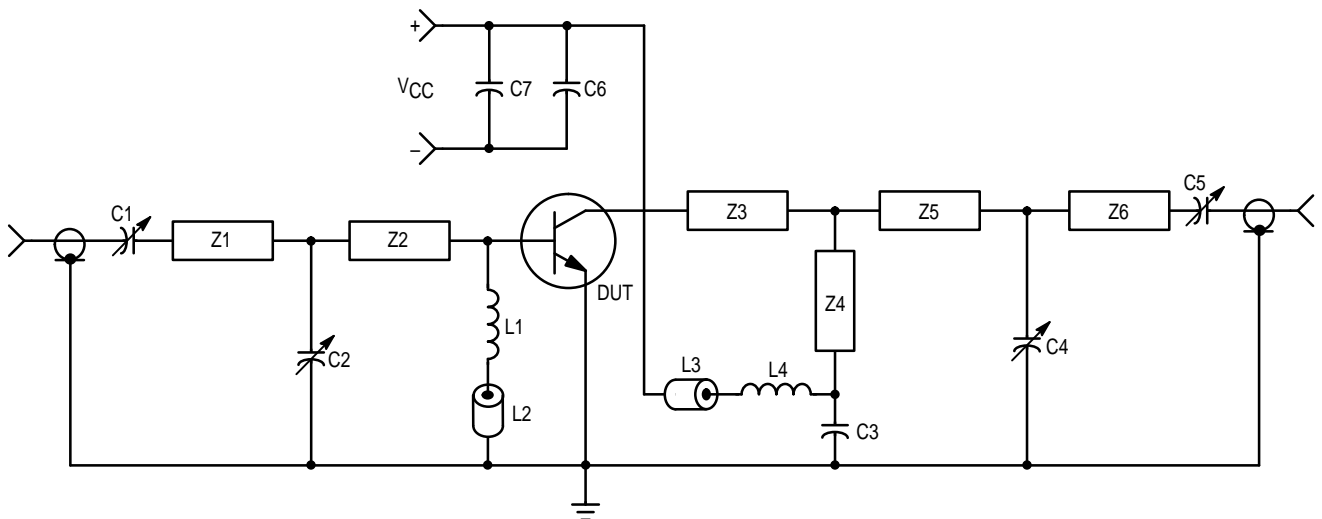

Figure 1. Power Dissipation



- | | |
|--|------------------------------|
| C1, C2, C4, C5 — 1.0–10 pF Johanson | Z1 — 50 Ω 1.5 cm |
| C3, C6 — 0.001 μF Chip Capacitor | Z2 — 30 Ω 2.5 cm |
| C7 — 1.0 μF Tantalum | Z3 — 50 Ω 2.0 cm |
| L1, L4 — 4 Turns #26 AWG, 0.3 cm ID, 0.4 cm Long | Z4 — 50 Ω 1.2 cm |
| L2, L3 — Ferrite Bead | Z5, Z6 — 50 Ω 1.25 cm |
| Microstrip Elements — $\epsilon_r = 2.55$ | |

Figure 2. 870 MHz Test Fixture

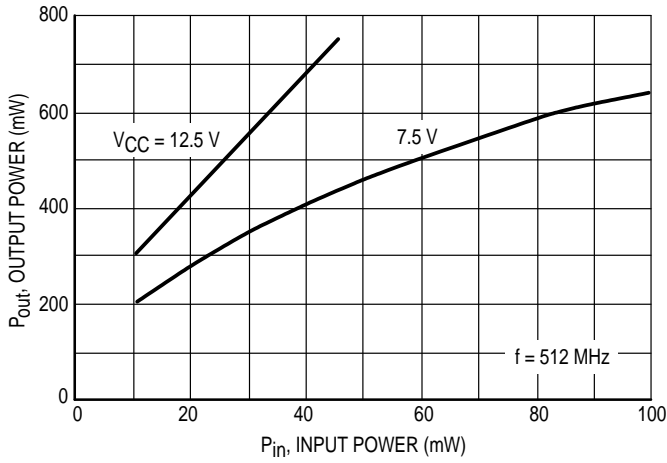

Figure 3. Output Power versus Input Power

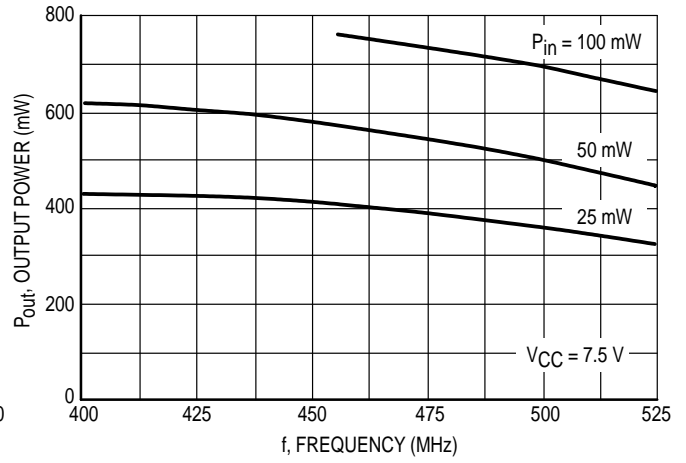

Figure 4. Output Power versus Frequency

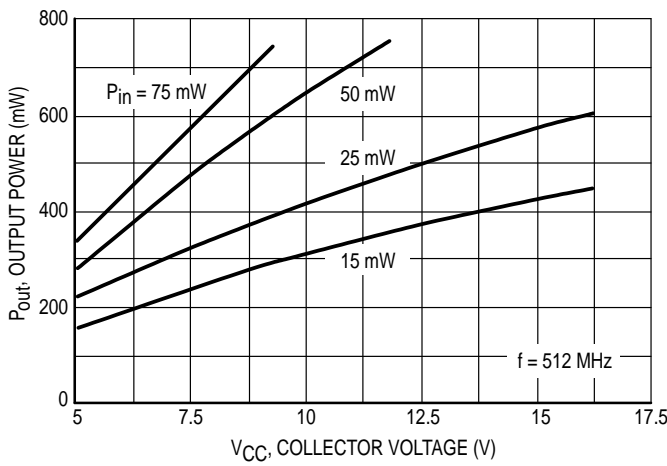

Figure 5. Output Power versus Collector Voltage

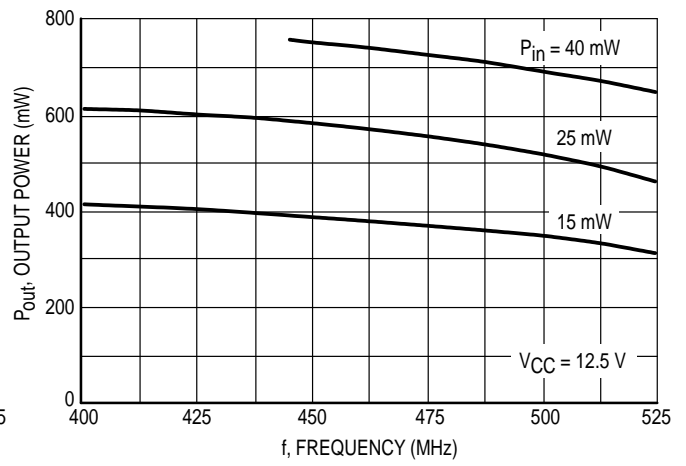

Figure 6. Output Power versus Frequency

f Frequency MHz	Z _{in} Ohms			Z _{OL} [*] Ohms					
	V _{CC} = 7.5–12.5 V			V _{CC} = 7.5 V			V _{CC} = 12.5 V		
	15 mW	25 mW	50 mW	0.25 W	0.5 W	0.75 W	0.25 W	0.5 W	0.75 W
400	4.3 – j13.3	4.9 – j11.0	5.7 – j8.7	31 – j49	44 – j34	42 – j4.9	20 – j68	42 – j60	52 – j54
440	3.9 – j8.8	4.5 – j8.7	5.4 – j6.9	27 – j42	39 – j30	40 – j6.9	19 – j62	37 – j54	49 – j50
480	3.5 – j4.4	4.1 – j6.5	5.0 – j4.3	24 – j36	36 – j25	39 – j9.0	18 – j56	33 – j48	47 – j46
520	3.2 – j2.2	3.8 – j4.3	4.7 – j1.7	22 – j30	34 – j20	37 – j12	17 – j52	31 – j44	47 – j42

Z_{OL}^{*} = Conjugate of the optimum load impedance into which the device output operates at a given output power, voltage and frequency.

Table 1. Z_{in} and Z_{OL} versus Collector Voltage, Input Power, and Output Power

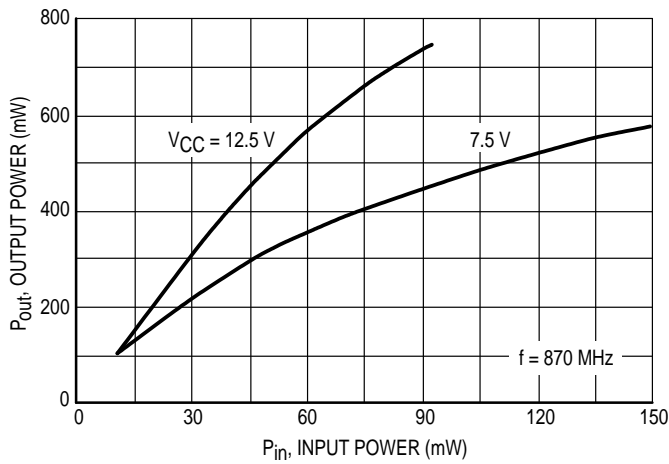

Figure 7. Output Power versus Input Power

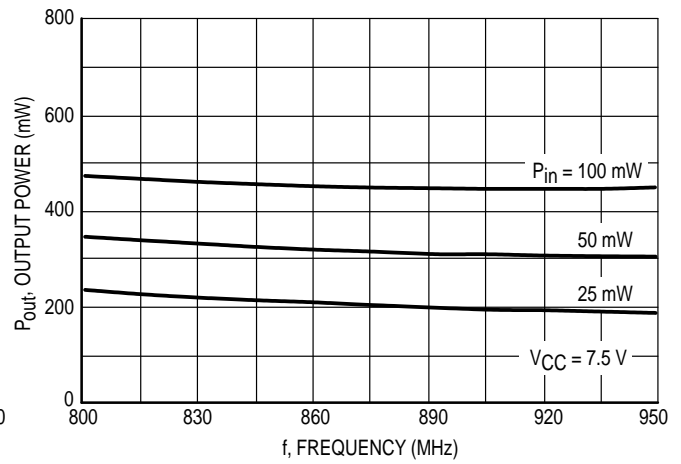

Figure 8. Output Power versus Frequency

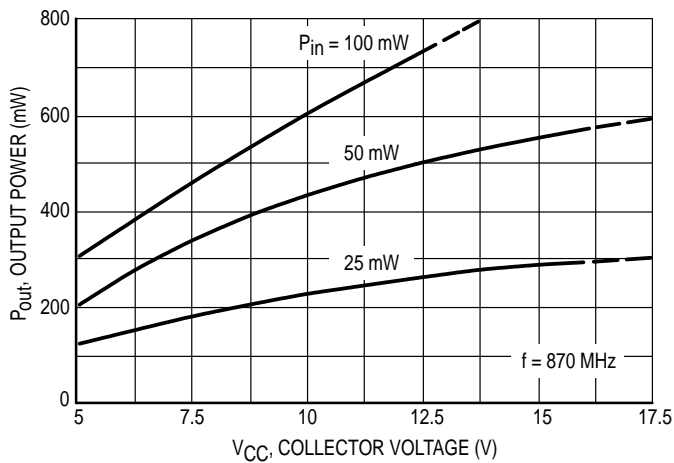

Figure 9. Output Power versus Collector Voltage

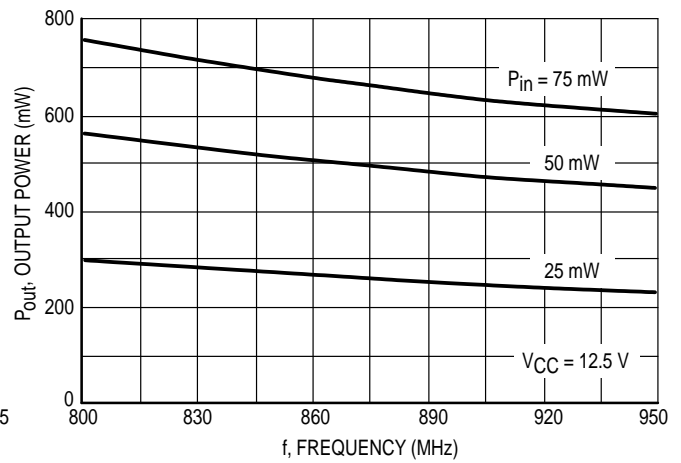
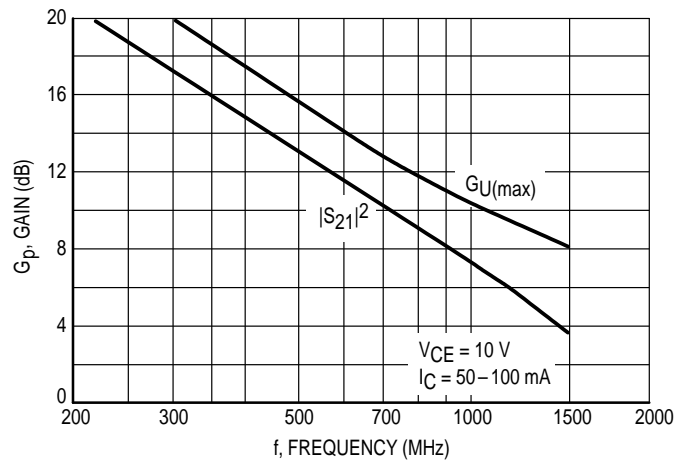

Figure 10. Output Power versus Frequency

f Frequency MHz	Z_{in} Ohms			Z_{OL}^* Ohms					
	$V_{CC} = 7.5-12.5\text{ V}$			$V_{CC} = 7.5\text{ V}$			$V_{CC} = 12.5\text{ V}$		
	25 mW	50 mW	100 mW	0.25 W	0.5 W	0.75 W	0.25 W	0.5 W	0.75 W
800	$2.9 + j2.2$	$3.8 + j4.4$	$4.7 + j6.5$	$15.0 - j36.8$	$22.7 - j30.6$	$27.1 - j22.6$	$14.6 - j43.6$	$17.2 - j39.7$	$23.4 - j37.7$
850	$3.2 + j3.5$	$3.8 + j5.2$	$4.8 + j7.4$	$15.7 - j35.3$	$23.9 - j28.7$	$27.3 - j21.5$	$16.3 - j40.8$	$17.8 - j39.5$	$23.7 - j36.8$
900	$3.8 + j5.7$	$4.4 + j7.0$	$5.4 + j8.7$	$16.4 - j33.7$	$25.1 - j27.0$	$27.5 - j20.5$	$17.3 - j38.2$	$18.3 - j39.3$	$23.9 - j36.0$
950	$4.1 + j7.4$	$4.5 + j8.8$	$5.5 + j10.1$	$17.0 - j32.2$	$26.3 - j25.2$	$27.6 - j19.4$	$17.2 - j36.1$	$20.1 - j38.5$	$24.5 - j35.6$

Z_{OL}^* = Conjugate of the optimum load impedance into which the device output operates at a given output power, voltage and frequency.

Table 2. Z_{in} and Z_{OL} versus Collector Voltage, Input Power, and Output Power



$$G_{U(max)} = \frac{|S_{21}|^2}{(1 - |S_{11}|^2)(1 - |S_{22}|^2)}$$

Figure 11. Gain versus Frequency

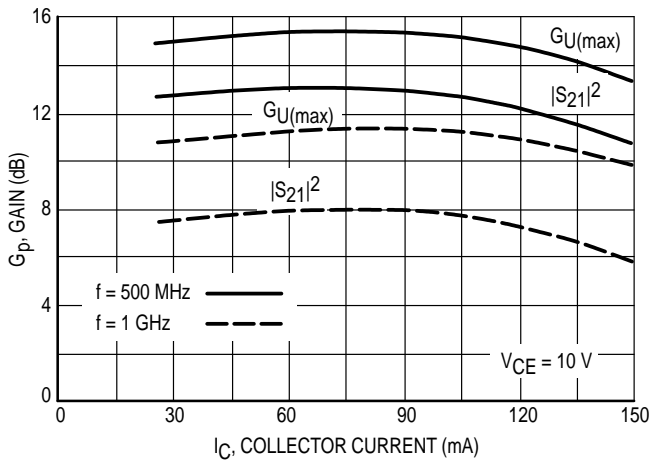

Figure 12. Gain versus Collector Current

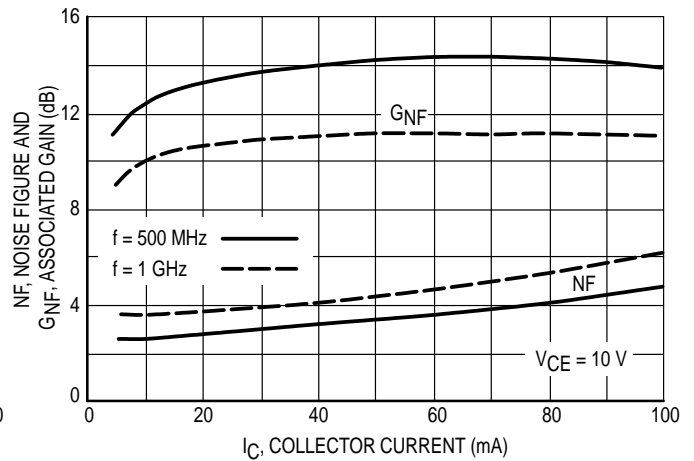

Figure 13. Noise Figure and Associated Gain versus Collector Current

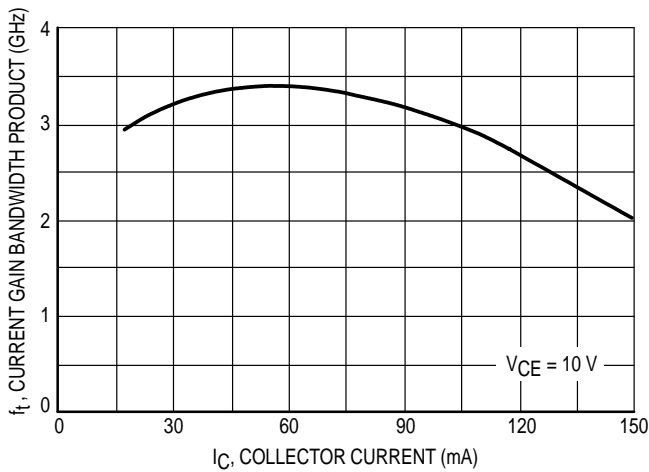

Figure 14. Current Gain Bandwidth Product versus Collector Current

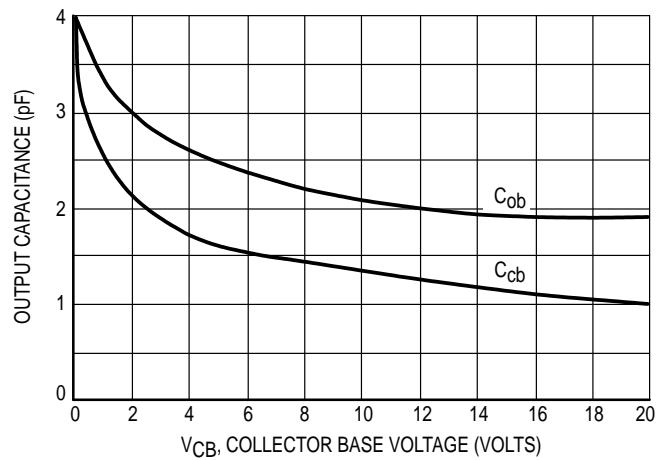
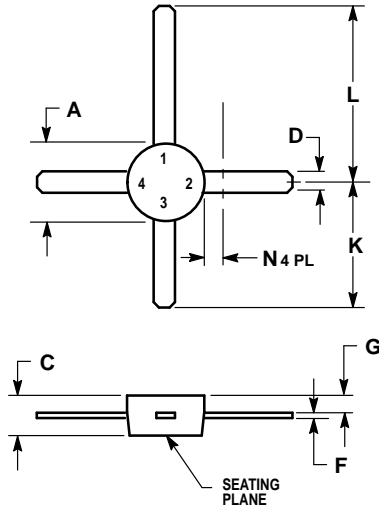

Figure 15. Output Capacitance versus Collector Base Voltage

V _{CE} (Volts)	I _C (mA)	f (MHz)	S ₁₁		S ₂₁		S ₁₂		S ₂₂	
			S ₁₁	∠φ	S ₂₁	∠φ	S ₁₂	∠φ	S ₂₂	∠φ
5.0	10	250	0.72	-161	6.20	93	0.057	30	0.30	-91
		500	0.73	179	3.16	76	0.069	43	0.27	-94
		1000	0.76	158	1.62	55	0.105	63	0.27	-119
		1500	0.82	142	1.08	41	0.155	70	0.41	-137
	25	250	0.70	-173	7.17	89	0.045	47	0.26	-123
		500	0.70	172	3.63	75	0.073	60	0.20	-128
		1000	0.74	152	1.90	54	0.134	67	0.21	-157
		1500	0.79	136	1.32	39	0.196	66	0.32	-167
	50	250	0.72	-178	7.63	89	0.038	56	0.27	-139
		500	0.72	170	3.85	77	0.068	67	0.23	-141
		1000	0.75	153	2.01	59	0.129	72	0.23	-162
		1500	0.81	137	1.40	46	0.188	70	0.32	-164
	100	250	0.73	179	7.34	88	0.036	61	0.26	-143
		500	0.74	169	3.70	77	0.067	71	0.22	-144
		1000	0.76	153	1.94	59	0.130	74	0.24	-166
		1500	0.81	138	1.36	46	0.191	71	0.32	-167
	150	250	0.78	176	5.19	92	0.033	64	0.22	-131
		500	0.78	167	2.76	78	0.065	74	0.21	-131
		1000	0.80	151	1.49	58	0.129	77	0.24	-155
		1500	0.85	135	1.05	45	0.191	73	0.35	-161
10	10	250	0.69	-157	7.03	94	0.050	33	0.34	-67
		500	0.70	-178	3.59	77	0.060	46	0.32	-69
		1000	0.74	160	1.84	55	0.094	67	0.29	-94
		1500	0.81	142	1.20	41	0.148	76	0.42	-121
	25	250	0.67	-168	8.30	91	0.039	46	0.24	-93
		500	0.68	176	4.25	77	0.060	60	0.21	-89
		1000	0.72	158	2.19	57	0.109	71	0.19	-114
		1500	0.78	142	1.47	44	0.165	74	0.31	-134
	50	250	0.68	-174	8.88	90	0.035	55	0.21	-110
		500	0.68	172	4.49	77	0.060	67	0.18	-104
		1000	0.72	155	2.31	59	0.113	74	0.17	-128
		1500	0.77	139	1.58	46	0.169	74	0.28	-140
	100	250	0.68	-178	8.49	89	0.030	61	0.19	-104
		500	0.69	170	4.32	76	0.060	71	0.17	-97
		1000	0.72	153	2.25	58	0.120	76	0.17	-123
		1500	0.78	137	1.53	44	0.180	75	0.28	-137
	150	250	0.72	178	6.53	91	0.029	64	0.22	-71
		500	0.73	169	3.37	77	0.056	75	0.24	-75
		1000	0.76	152	1.79	57	0.112	80	0.22	-105
		1500	0.83	137	1.22	43	0.175	79	0.34	-129

Table 3. Common Emitter Scattering Parameters

PACKAGE DIMENSIONS



NOTES:
1. DIMENSION D NOT APPLICABLE IN ZONE N.

DIM	MILLIMETERS		INCHES	
	MIN	MAX	MIN	MAX
A	4.44	5.21	0.175	0.205
C	1.90	2.54	0.075	0.100
D	0.84	0.99	0.033	0.039
F	0.20	0.30	0.080	0.012
G	0.76	1.14	0.030	0.045
K	7.24	8.13	0.285	0.320
L	10.54	11.43	0.415	0.450
N	—	1.65	—	0.065

STYLE 2:
PIN 1. COLLECTOR
2. EMITTER
3. BASE
4. EMITTER

**CASE 317-01
ISSUE E**

Motorola reserves the right to make changes without further notice to any products herein. Motorola makes no warranty, representation or guarantee regarding the suitability of its products for any particular purpose, nor does Motorola assume any liability arising out of the application or use of any product or circuit, and specifically disclaims any and all liability, including without limitation consequential or incidental damages. "Typical" parameters which may be provided in Motorola data sheets and/or specifications can and do vary in different applications and actual performance may vary over time. All operating parameters, including "Typicals" must be validated for each customer application by customer's technical experts. Motorola does not convey any license under its patent rights nor the rights of others. Motorola products are not designed, intended, or authorized for use as components in systems intended for surgical implant into the body, or other applications intended to support or sustain life, or for any other application in which the failure of the Motorola product could create a situation where personal injury or death may occur. Should Buyer purchase or use Motorola products for any such unintended or unauthorized application, Buyer shall indemnify and hold Motorola and its officers, employees, subsidiaries, affiliates, and distributors harmless against all claims, costs, damages, and expenses, and reasonable attorney fees arising out of, directly or indirectly, any claim of personal injury or death associated with such unintended or unauthorized use, even if such claim alleges that Motorola was negligent regarding the design or manufacture of the part. Motorola and  are registered trademarks of Motorola, Inc. Motorola, Inc. is an Equal Opportunity/Affirmative Action Employer.

Mfax is a trademark of Motorola, Inc.

How to reach us:

USA/EUROPE/Locations Not Listed: Motorola Literature Distribution;
P.O. Box 5405, Denver, Colorado 80217. 1-303-675-2140 or 1-800-441-2447

JAPAN: Nippon Motorola Ltd.: SPD, Strategic Planning Office, 141,
4-32-1 Nishi-Gotanda, Shagawa-ku, Tokyo, Japan. 03-5487-8488

Customer Focus Center: 1-800-521-6274

Mfax™: RMFAX0@email.sps.mot.com – TOUCHTONE 1-602-244-6609
Motorola Fax Back System – US & Canada ONLY 1-800-774-1848
– http://sps.motorola.com/mfax/

ASIA/PACIFIC: Motorola Semiconductors H.K. Ltd.; 8B Tai Ping Industrial Park,
51 Ting Kok Road, Tai Po, N.T., Hong Kong. 852-26629298

HOME PAGE: <http://motorola.com/sps/>



MOTOROLA



MRF559/D