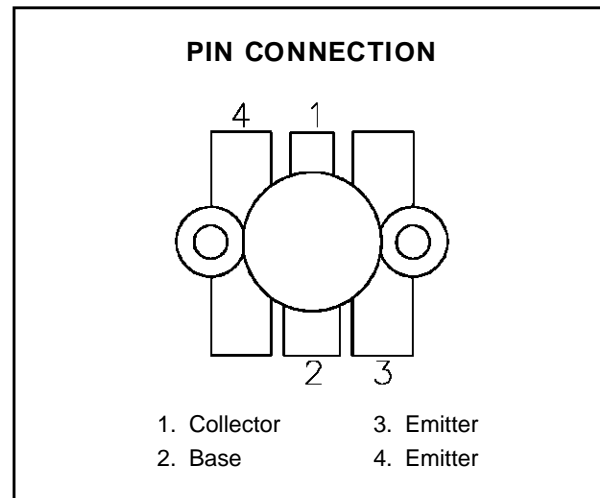
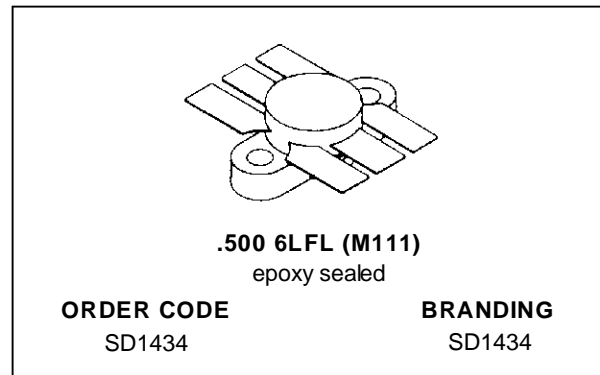

**RF & MICROWAVE TRANSISTORS
UHF MOBILE APPLICATIONS**

- 470 MHz
- 12.5 VOLTS
- COMMON EMITTER
- $P_{OUT} = 45 \text{ W MIN. WITH } 5.0 \text{ dB GAIN}$

DESCRIPTION

The SD1434 is a 12.5 V Class C epitaxial silicon NPN planar transistor designed primarily for UHF communications. This device utilizes diffused emitter resistors to achieve infinite VSWR under operating conditions.

ABSOLUTE MAXIMUM RATINGS ($T_{case} = 25^{\circ}\text{C}$)

Symbol	Parameter	Value	Unit
V_{CBO}	Collector-Base Voltage	36	V
V_{CEO}	Collector-Emitter Voltage	16	V
V_{CES}	Collector-Emitter Voltage	36	V
V_{EBO}	Emitter-Base Voltage	4.0	V
I_C	Device Current	10.0	A
P_{DISS}	Power Dissipation	175	W
T_J	Junction Temperature	+200	$^{\circ}\text{C}$
T_{STG}	Storage Temperature	- 65 to +150	$^{\circ}\text{C}$

THERMAL DATA

$R_{TH(j-c)}$	Junction-Case Thermal Resistance	1.0	$^{\circ}\text{C/W}$
---------------	----------------------------------	-----	----------------------

SD1434

ELECTRICAL SPECIFICATIONS (T_{case} = 25°C)

STATIC

Symbol	Test Conditions		Value			Unit
			Min.	Typ.	Max.	
BV _{CBO}	I _C = 5mA	I _E = 0mA	36	—	—	V
BV _{CES}	I _C = 20mA	V _{BE} = 0V	36	—	—	V
BV _{CEO}	I _C = 50mA	I _B = 0mA	16	—	—	V
BV _{EBO}	I _E = 5mA	I _C = 0mA	4.0	—	—	V
I _{CES}	V _{CE} = 22V	I _E = 0mA	—	—	5	mA
I _{CBO}	V _{CB} = 15V	I _E = 0mA	—	—	5	mA
h _{FE}	V _{CE} = 5V	I _C = 1A	20	—	200	—

DYNAMIC

Symbol	Test Conditions			Value			Unit
				Min.	Typ.	Max.	
P _{OUT}	f = 470 MHz	P _{IN} = 14 W	V _{CE} = 12.5 V	45	—	—	W
G _P	f = 470 MHz	P _{IN} = 14 W	V _{CE} = 12.5 V	5	—	—	dB
C _{OB}	f = 1 MHz	V _{CB} = 12.5 V		—	130	—	pF

TYPICAL PERFORMANCE

POWER OUTPUT vs POWER INPUT

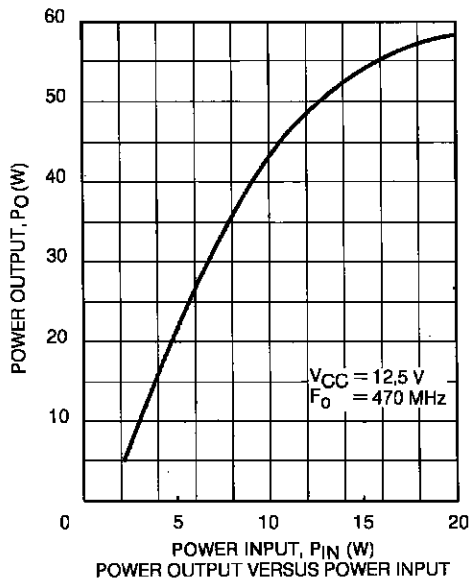

POWER OUTPUT vs FREQUENCY

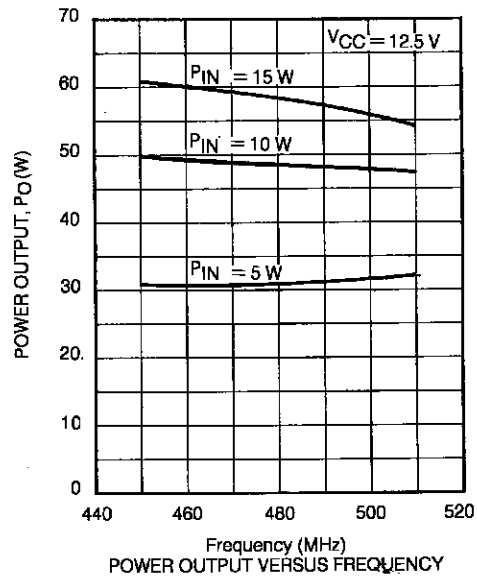

TYPICAL PERFORMANCE (cont'd)

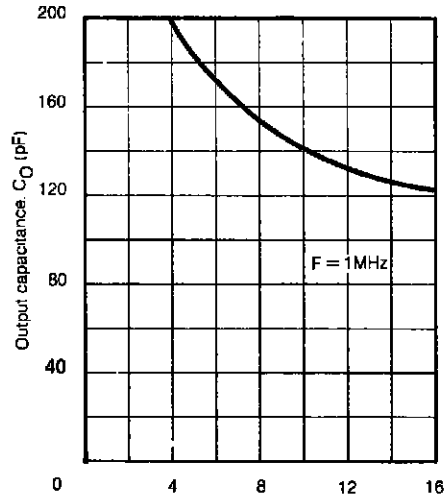
OUTPUT CAPACITANCE vs COLLECTOR
BASE VOLTAGE

Collector - base voltage, V_{CB} (V)
OUTPUT CAPACITANCE VERSUS
COLLECTOR - BASE VOLTAGE

IMPEDANCE DATA

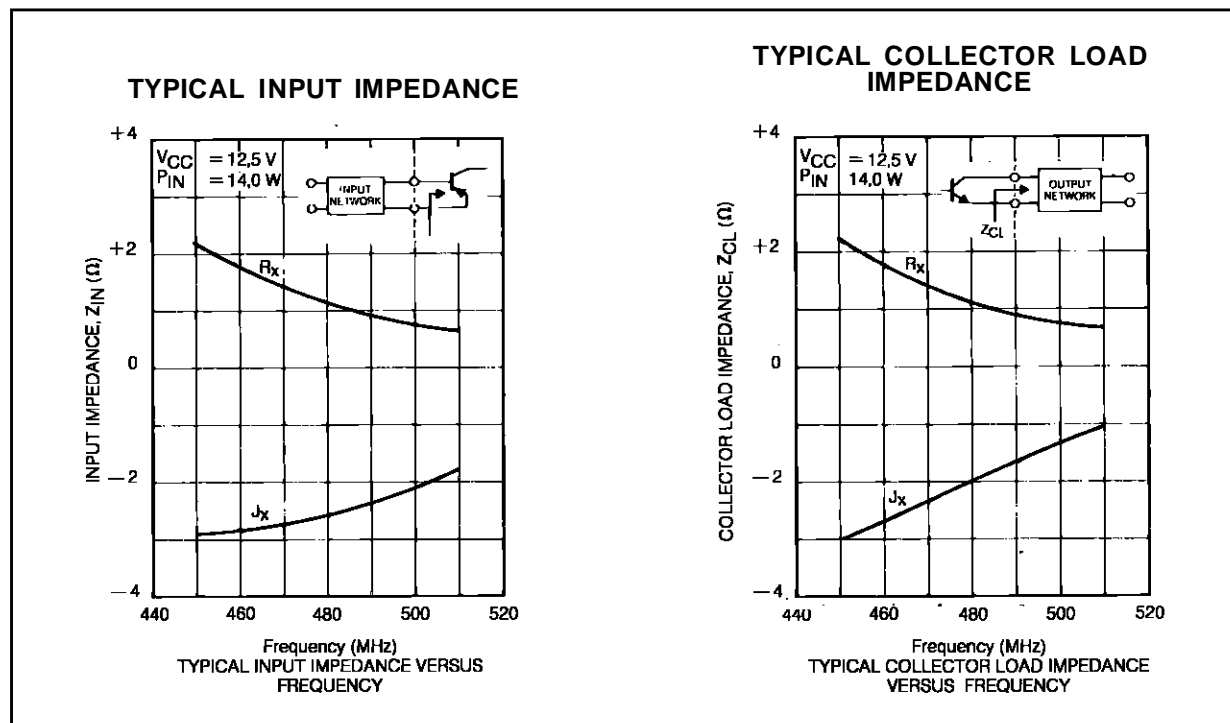

TEST CIRCUIT

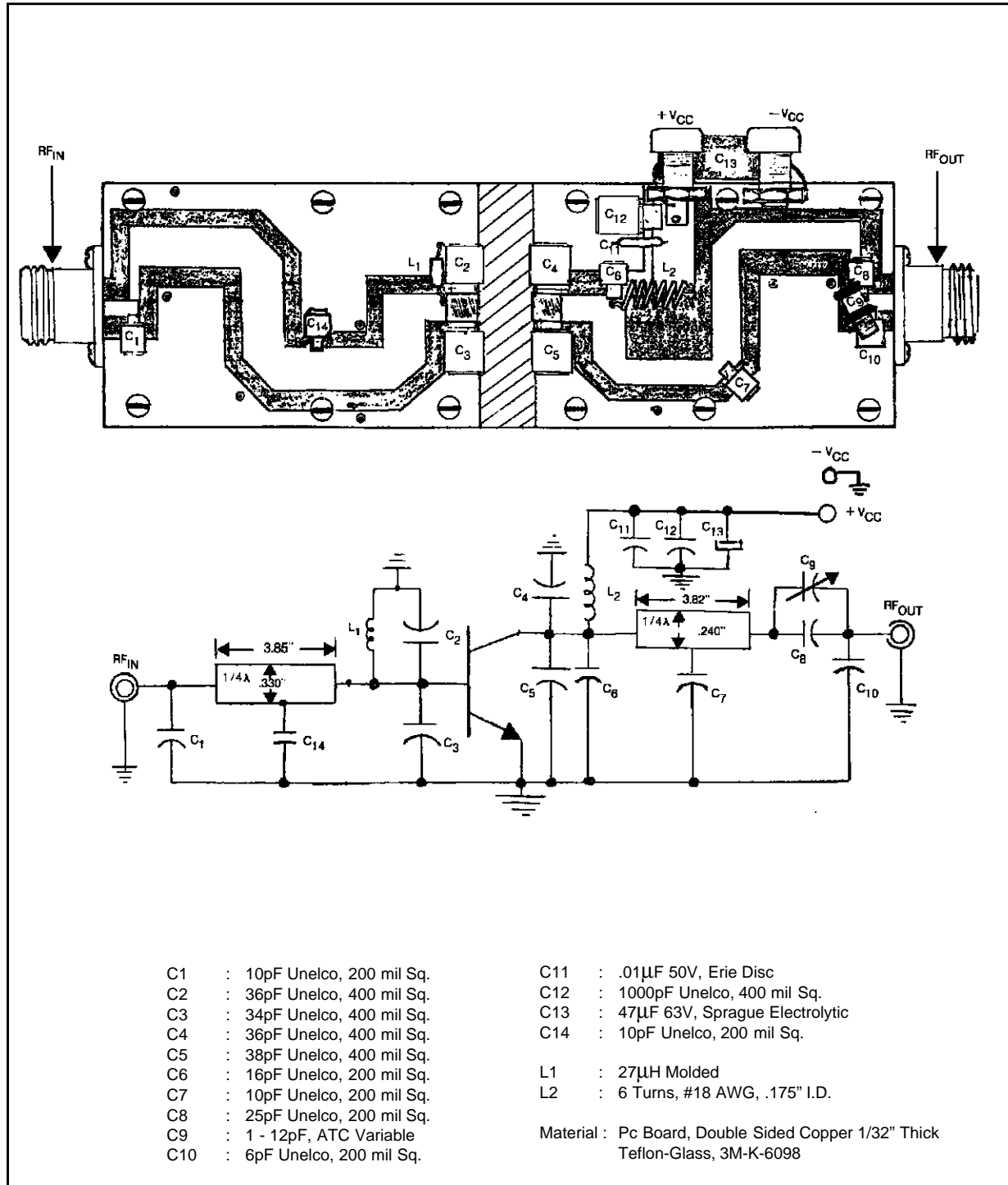

PACKAGE MECHANICAL DATA

Ref.: Dwg. No.12-0111

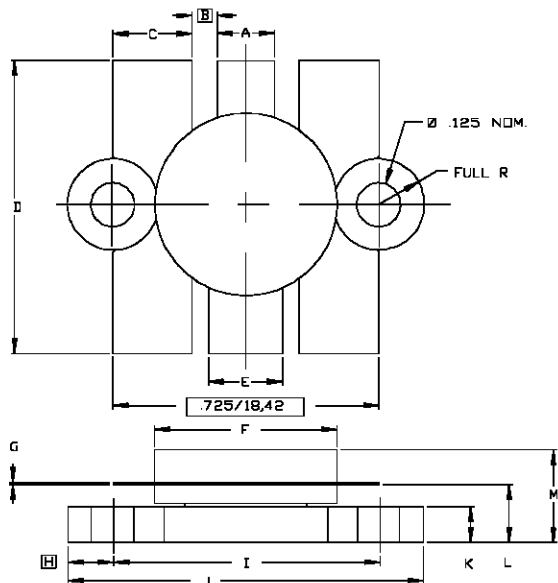

SGS-THOMSON MICROELECTRONICS			CONT'D		
	MINIMUM Inches/mm	MAXIMUM Inches/mm		MINIMUM Inches/mm	MAXIMUM Inches/mm
A	.150/3,43	.160/4,06	K	.095/2,41	.105/2,67
B	.045/1,14		L	.150/3,81	.170/4,32
C	.210/5,33	.220/5,59	M		.280/7,11
D	.835/21,21	.865/21,97			
E	.200/5,08	.210/5,33			
F	.490/12,45	.510/12,95			
G	.003/0,08	.007/0,18			
H	.125/3,18				
I	.720/18,29	.730/18,54			
J	.970/24,64	.980/24,89			

Information furnished is believed to be accurate and reliable. However, SGS-THOMSON Microelectronics assumes no responsibility for the consequences of use of such information nor for any infringement of patents or other rights of third parties which may result from its use. No license is granted by implication or otherwise under any patent or patent rights of SGS-THOMSON Microelectronics. Specifications mentioned in this publication are subject to change without notice. This publication supersedes and replaces all information previously supplied. SGS-THOMSON Microelectronics products are not authorized for use as critical components in life support devices or systems without express written approval of SGS-THOMSON Microelectronics.

© 1994 SGS-THOMSON Microelectronics - All Rights Reserved

SGS-THOMSON Microelectronics GROUP OF COMPANIES
 Australia - Brazil - France - Germany - Hong Kong - Italy - Japan - Korea - Malaysia - Malta - Morocco - The Netherlands -
 Singapore - Spain - Sweden - Switzerland - Taiwan - Thailand - United Kingdom - U.S.A