

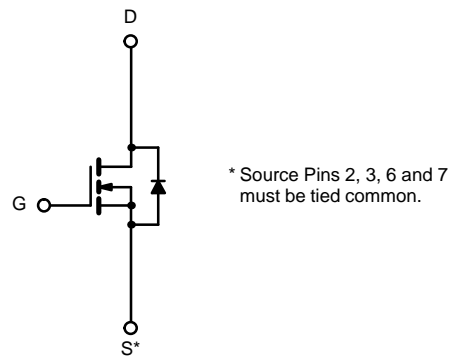

N-Channel 2.5-V (G-S) MOSFET

PRODUCT SUMMARY		
V_{DS} (V)	$r_{DS(on)}$ (Ω)	I_D (A)
20	0.014 @ $V_{GS} = 4.5$ V	± 7.8
	0.021 @ $V_{GS} = 2.5$ V	± 6.3

TrenchFET[®]
Power MOSFETs
2.5-V Rated

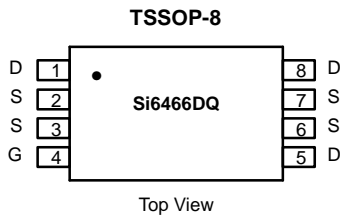

N-Channel MOSFET

ABSOLUTE MAXIMUM RATINGS ($T_A = 25^\circ\text{C}$ UNLESS OTHERWISE NOTED)			
Parameter	Symbol	Limit	Unit
Drain-Source Voltage	V_{DS}	20	V
Gate-Source Voltage	V_{GS}	± 12	
Continuous Drain Current ($T_J = 150^\circ\text{C}$) ^a	I_D	$T_A = 25^\circ\text{C}$	± 7.8
		$T_A = 70^\circ\text{C}$	± 6.2
Pulsed Drain Current	I_{DM}	± 30	A
Continuous Source Current (Diode Conduction) ^a	I_S	1.50	
Maximum Power Dissipation ^a	P_D	$T_A = 25^\circ\text{C}$	1.5
		$T_A = 70^\circ\text{C}$	1.0
Operating Junction and Storage Temperature Range	T_J, T_{stg}	-55 to 150	$^\circ\text{C}$

THERMAL RESISTANCE RATINGS			
Parameter	Symbol	Limit	Unit
Maximum Junction-to-Ambient ^a	R_{thJA}	83	$^\circ\text{C/W}$

Notes

a. Surface Mounted on FR4 Board, $t \leq 10$ sec.

For SPICE model information via the Worldwide Web: <http://www.vishay.com/www/product/spice.htm>



SPECIFICATIONS (T_J = 25 °C UNLESS OTHERWISE NOTED)

Parameter	Symbol	Test Condition	Min	Typ	Max	Unit
Static						
Gate Threshold Voltage	V _{GS(th)}	V _{DS} = V _{GS} , I _D = 250 μA	0.6			V
Gate-Body Leakage	I _{GSS}	V _{DS} = 0 V, V _{GS} = ±12 V			±100	nA
Zero Gate Voltage Drain Current	I _{DSS}	V _{DS} = 20 V, V _{GS} = 0 V			1	μA
		V _{DS} = 20 V, V _{GS} = 0 V, T _J = 55 °C			25	
On-State Drain Current ^a	I _{D(on)}	V _{DS} = 5 V, V _{GS} = 10 V	20			A
Drain-Source On-State Resistance ^a	r _{DS(on)}	V _{GS} = 4.5 V, I _D = 7.8 A		0.0105	0.014	Ω
		V _{GS} = 2.5 V, I _D = 6.3 A		0.0135	0.021	
Forward Transconductance ^a	g _{fs}	V _{DS} = 10 V, I _D = 7.8 A		45		S
Diode Forward Voltage ^a	V _{SD}	I _S = 1.50 A, V _{GS} = 0 V		0.7	1.1	V
Dynamic^b						
Total Gate Charge	Q _g	V _{DS} = 10 V, V _{GS} = 4.5 V, I _D = 7.8 A		34	60	nC
Gate-Source Charge	Q _{gs}			6.7		
Gate-Drain Charge	Q _{gd}			8.1		
Turn-On Delay Time	t _{d(on)}	V _{DD} = 10 V, R _L = 10 Ω I _D ≅ 1 A, V _{GEN} = 10 V, R _G = 6 Ω		19	40	ns
Rise Time	t _r			30	60	
Turn-Off Delay Time	t _{d(off)}			130	250	
Fall Time	t _f			40	80	
Source-Drain Reverse Recovery Time	t _{rr}	I _F = 1.50 A, di/dt = 100 A/μs		50	80	

Notes

- a. Pulse test; pulse width ≤ 300 μs, duty cycle ≤ 2%.
- b. Guaranteed by design, not subject to production testing.



TYPICAL CHARACTERISTICS (25°C UNLESS NOTED)

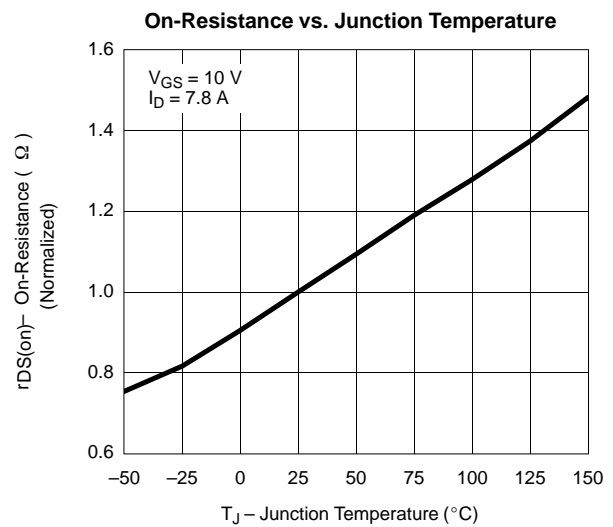
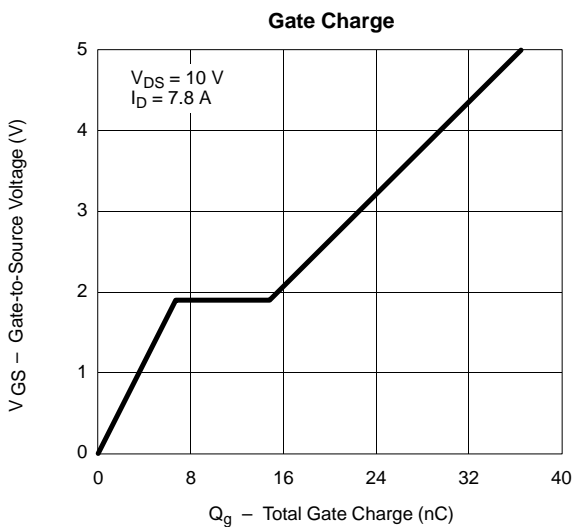
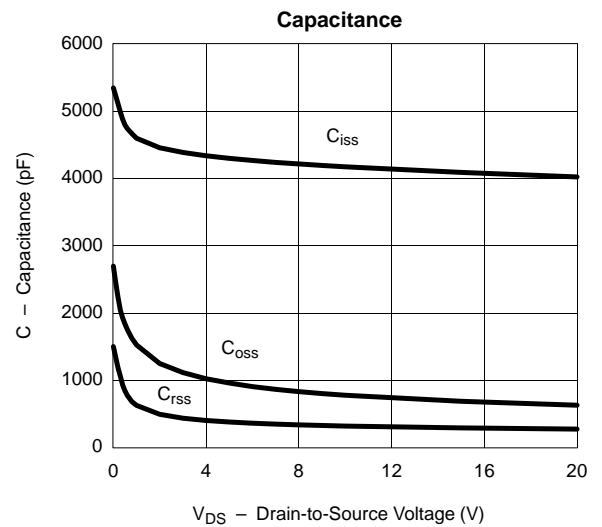
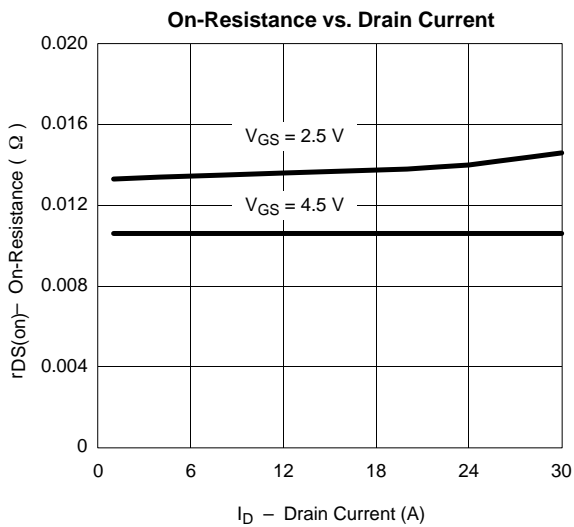
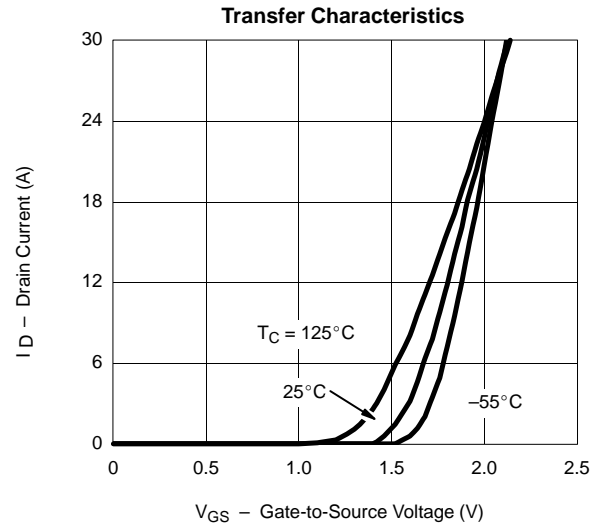
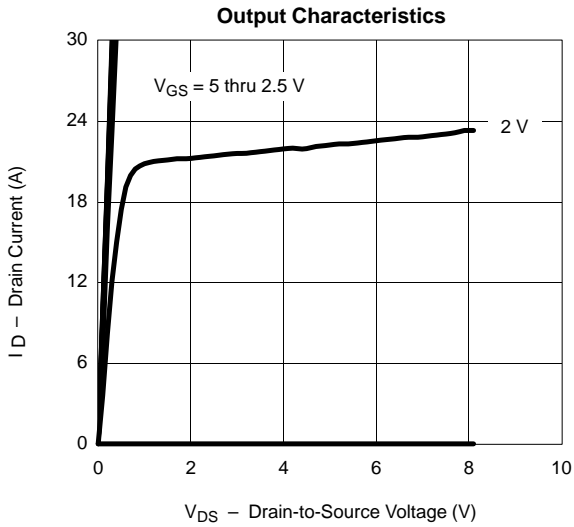



TYPICAL CHARACTERISTICS (25°C UNLESS NOTED)

