

P-Channel Enhancement-Mode MOSFET

Product Summary

V _{DS} (V)	r _{DS(on)} (Ω)	I _D (A)
-20	0.25 @ V _{GS} = -10 V	±2.5
	0.40 @ V _{GS} = -4.5 V	±2.0

Recommended upgrade: Si4947DY

Lower profile/smaller size—see LITE FOOT® equivalent: Si6953DQ

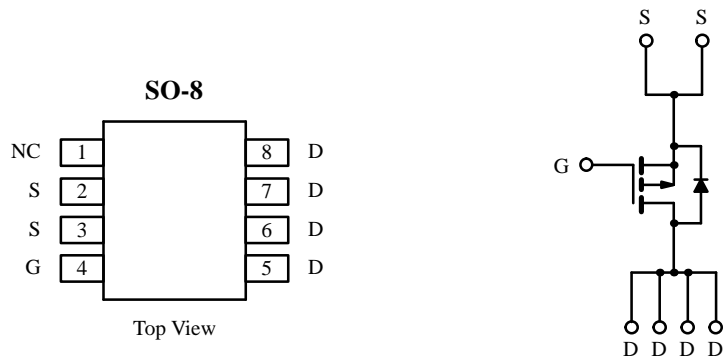

P-Channel MOSFET

Absolute Maximum Ratings (T_A = 25°C Unless Otherwise Noted)

Parameter	Symbol	Limit	Unit
Drain-Source Voltage	V _{DS}	-20	V
Gate-Source Voltage	V _{GS}	±20	
Continuous Drain Current (T _J = 150°C) ^a	I _D	T _A = 25°C	±2.5
		T _A = 70°C	±2.0
Pulsed Drain Current	I _{DM}	±10	A
Continuous Source Current (Diode Conduction) ^a	I _S	-2.0	
Maximum Power Dissipation ^a	P _D	T _A = 25°C	2.5
		T _A = 70°C	1.6
Operating Junction and Storage Temperature Range	T _J , T _{stg}	-55 to 150	°C

Thermal Resistance Ratings

Parameter	Symbol	Limit	Unit
Maximum Junction-to-Ambient ^a	R _{thJA}	50	°C/W

Notes

a. Surface Mounted on FR4 Board, t ≤ 10 sec.

Subsequent updates to this data sheet may be obtained via facsimile by calling Siliconix FaxBack, 1-408-970-5600. Please request FaxBack document #1201. A SPICE Model data sheet is available for this product (FaxBack document #5101).

Specifications ($T_J = 25^\circ\text{C}$ Unless Otherwise Noted)

Parameter	Symbol	Test Condition	Min	Typ ^a	Max	Unit
Static						
Gate Threshold Voltage	$V_{GS(th)}$	$V_{DS} = V_{GS}, I_D = -250 \mu\text{A}$	-1.0			V
Gate-Body Leakage	I_{GSS}	$V_{DS} = 0 \text{ V}, V_{GS} = \pm 20 \text{ V}$			± 100	nA
Zero Gate Voltage Drain Current	I_{DSS}	$V_{DS} = -16 \text{ V}, V_{GS} = 0 \text{ V}$			-2	μA
		$V_{DS} = -16 \text{ V}, V_{GS} = 0 \text{ V}, T_J = 55^\circ\text{C}$			-25	
On-State Drain Current ^b	$I_{D(on)}$	$V_{DS} \leq -5 \text{ V}, V_{GS} = -10 \text{ V}$	-10			A
Drain-Source On-State Resistance ^b	$r_{DS(on)}$	$V_{GS} = -10 \text{ V}, I_D = 1 \text{ A}$		0.16	0.25	Ω
		$V_{GS} = -4.5 \text{ V}, I_D = 0.5 \text{ A}$		0.30	0.40	
Forward Transconductance ^b	g_{fs}	$V_{DS} = -15 \text{ V}, I_D = -2.5 \text{ A}$		2.5		S
Diode Forward Voltage ^b	V_{SD}	$I_S = -1.25 \text{ A}, V_{GS} = 0 \text{ V}$		-0.9	-1.6	V
Dynamic^a						
Total Gate Charge	Q_g	$V_{DS} = -10 \text{ V}, V_{GS} = -10 \text{ V}, I_D = -2.0 \text{ A}$		5.4	25	nC
Gate-Source Charge	Q_{gs}			0.9		
Gate-Drain Charge	Q_{gd}			1.4		
Turn-On Delay Time	$t_{d(on)}$	$V_{DD} = -10 \text{ V}, R_L = 10 \Omega$ $I_D \cong -1 \text{ A}, V_{GEN} = -10 \text{ V}, R_G = 6 \Omega$		10	40	ns
Rise Time	t_r			10	40	
Turn-Off Delay Time	$t_{d(off)}$			38	90	
Fall Time	t_f			27	50	
Source-Drain Reverse Recovery Time	t_{rr}	$I_F = 2 \text{ A}, di/dt = 100 \text{ A}/\mu\text{s}$		69	100	

Notes

- a. For design aid only; not subject to production testing.
b. Pulse test; pulse width $\leq 300 \mu\text{s}$, duty cycle $\leq 2\%$.

Typical Characteristics (25°C Unless Otherwise Noted)

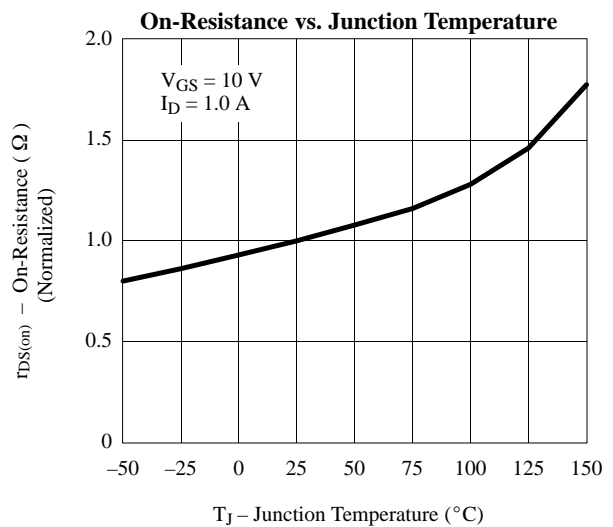
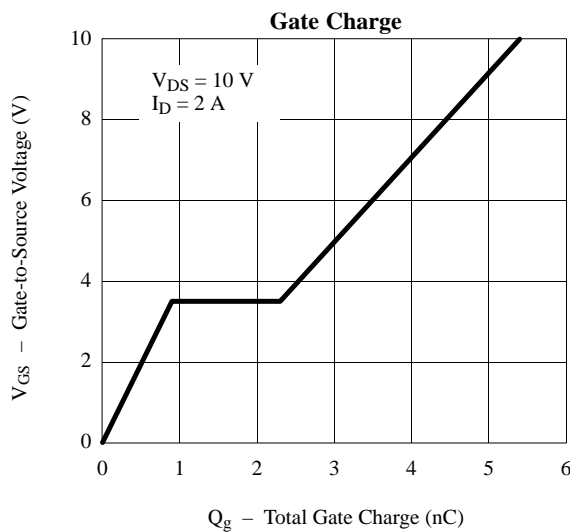
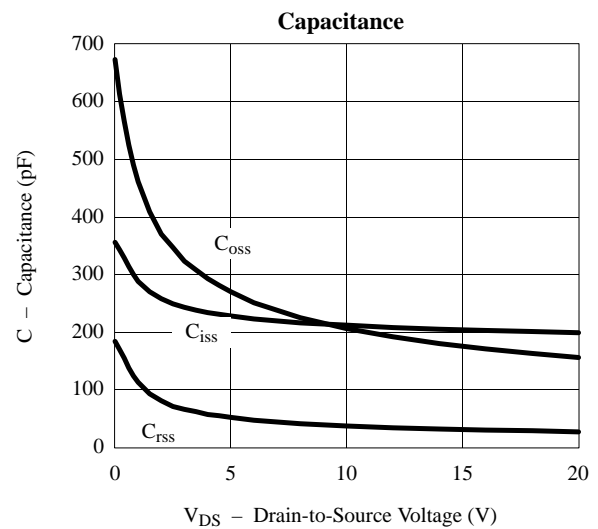
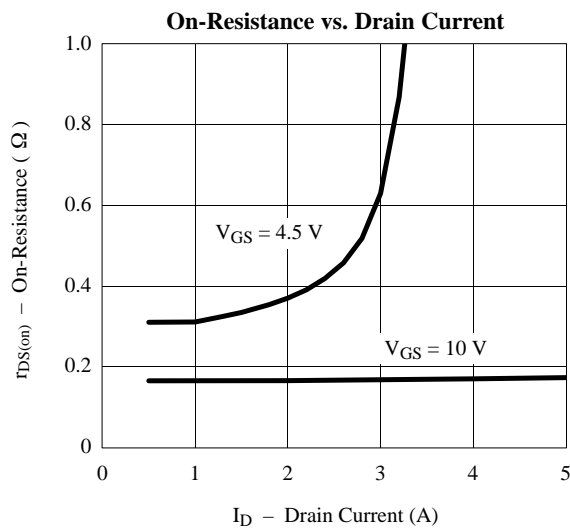
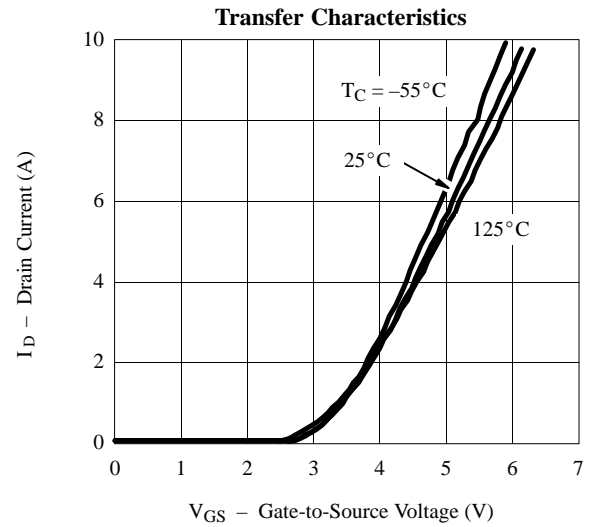
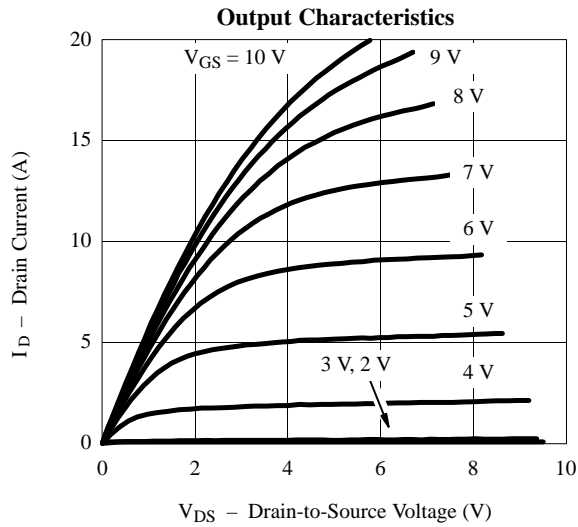

Typical Characteristics (25°C Unless Otherwise Noted)

