

TOSHIBA Field Effect Transistor Silicon P Channel MOS Type

SSM3J01F

High Speed Switching Applications

- Small package
- Low on resistance: $R_{on} = 0.4 \Omega$ (max) ($V_{GS} = -4 V$)
: $R_{on} = 0.6 \Omega$ (max) ($V_{GS} = -2.5 V$)
- Low gate threshold voltage

Maximum Ratings ($T_a = 25^\circ C$)

Characteristics		Symbol	Rating	Unit
Drain-source voltage		V_{DS}	-30	V
Gate-source voltage		V_{GSS}	± 10	V
Drain current	DC	I_D	-700	mA
	Pulse	I_{DP}	-1400	
Drain power dissipation ($T_a = 25^\circ C$)		P_D	200	mW
Channel temperature		T_{ch}	150	$^\circ C$
Storage temperature range		T_{stg}	-55~150	$^\circ C$

Unit: mm

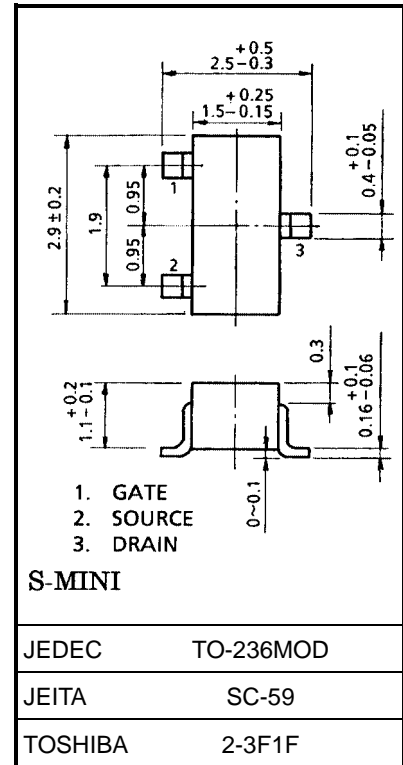

Weight: 0.012 g (typ.)

Marking

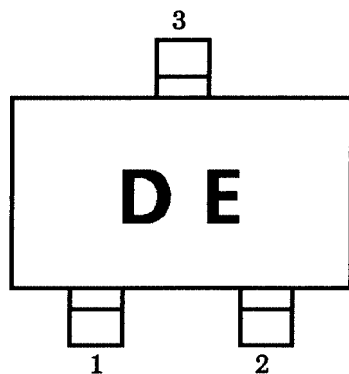

Equivalent Circuit

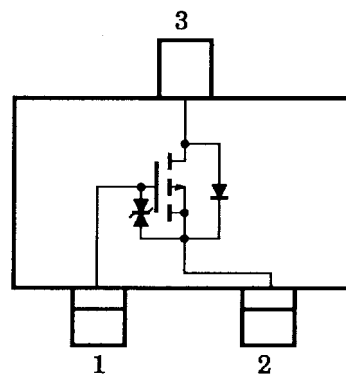

Handling Precaution

When handling individual devices (which are not yet mounting on a circuit board), be sure that the environment is protected against electrostatic electricity. Operators should wear anti-static clothing, and containers and other objects that come into direct contact with devices should be made of anti-static materials.

Electrical Characteristics (Ta = 25°C)

Characteristics	Symbol	Test Condition	Min	Typ.	Max	Unit
Gate leakage current	I_{GSS}	$V_{GS} = \pm 10\text{ V}, V_{DS} = 0$	—	—	± 1	μA
Drain-source breakdown voltage	$V_{(BR)DSS}$	$I_D = -1\text{ mA}, V_{GS} = 0$	-30	—	—	V
Drain cut-off current	I_{DSS}	$V_{DS} = -30\text{ V}, V_{GS} = 0$	—	—	-1	μA
Gate threshold voltage	V_{th}	$V_{DS} = -3\text{ V}, I_D = -0.1\text{ mA}$	-0.6	—	-1.1	V
Forward transfer admittance	$ Y_{fs} $ (Note)	$V_{DS} = -3\text{ V}, I_D = -0.35\text{ A}$	1.0	—	—	S
Drain-source ON resistance	$R_{DS(ON)}$ (Note)	$I_D = -0.35\text{ A}, V_{GS} = -4\text{ V}$	—	0.3	0.4	Ω
		$I_D = -0.35\text{ A}, V_{GS} = -2.5\text{ V}$	—	0.4	0.6	
Input capacitance	C_{iss}	$V_{DS} = -10\text{ V}, V_{GS} = 0, f = 1\text{ MHz}$	—	240	—	pF
Reverse transfer capacitance	C_{rss}	$V_{DS} = -10\text{ V}, V_{GS} = 0, f = 1\text{ MHz}$	—	24	—	pF
Output capacitance	C_{oss}	$V_{DS} = -10\text{ V}, V_{GS} = 0, f = 1\text{ MHz}$	—	94	—	pF
Switching time	Turn-on time	$V_{DD} = -15\text{ V}, I_D = -0.3\text{ A},$ $V_{GS} = 0 \sim -2.5\text{ V}, R_G = 4.7\text{ }\Omega$	—	36	—	ns
	Turn-off time		—	37	—	

Note: Pulse test

Switching Time Test Circuit

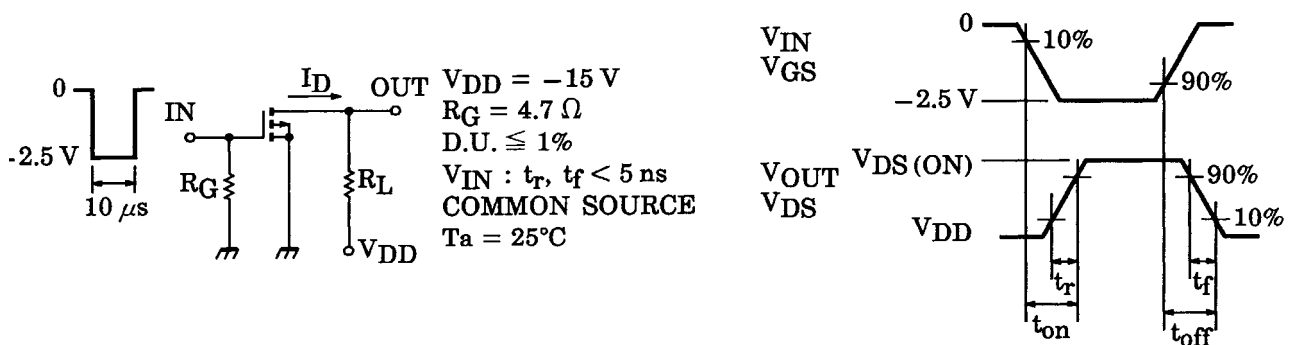

Precaution

V_{th} can be expressed as voltage between gate and source when low operating current value is $I_D = -100\text{ }\mu\text{A}$ for this product. For normal switching operation, $V_{GS(ON)}$ requires higher voltage than V_{th} and $V_{GS(off)}$ requires lower voltage than V_{th} .

(Relationship can be established as follows: $V_{GS(off)} < V_{th} < V_{GS(ON)}$)

Please take this into consideration for using the device.

V_{GS} recommended voltage of -2.5 V or higher to turn on this product.

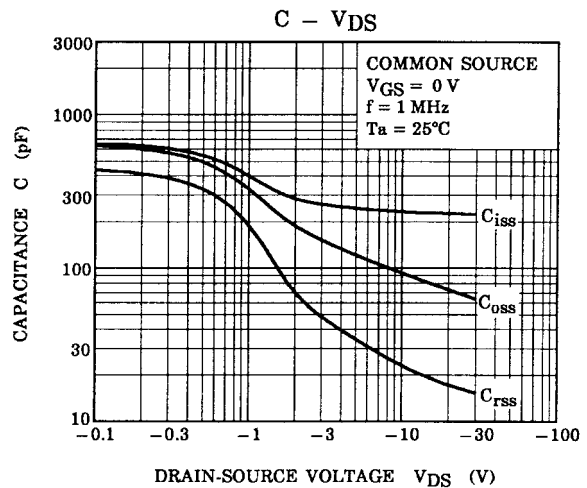
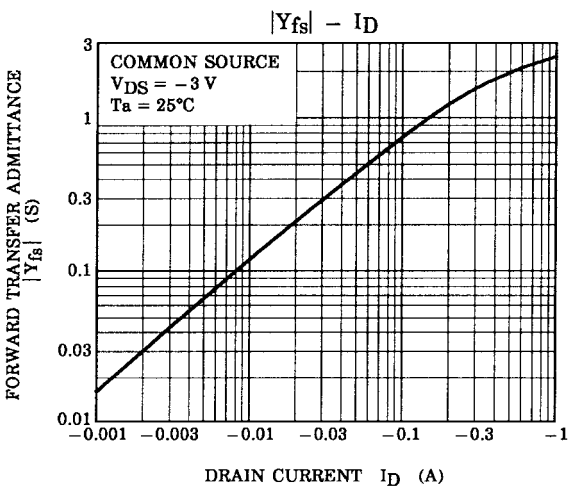
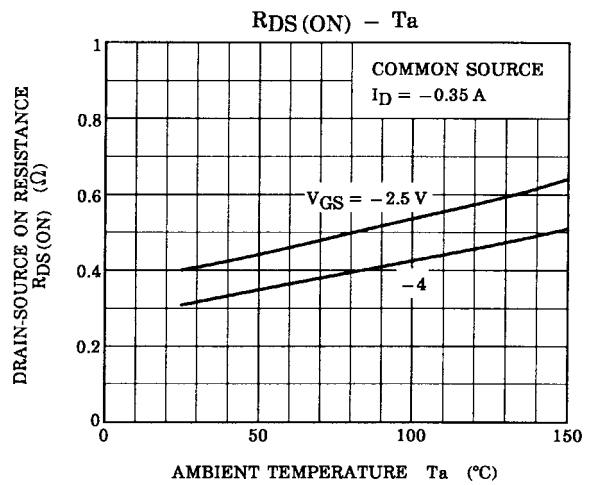
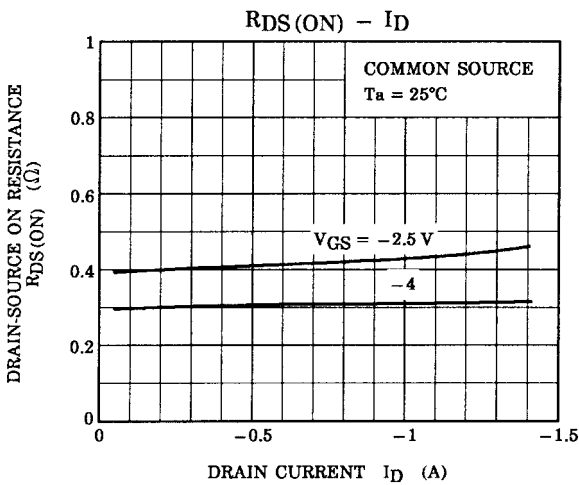
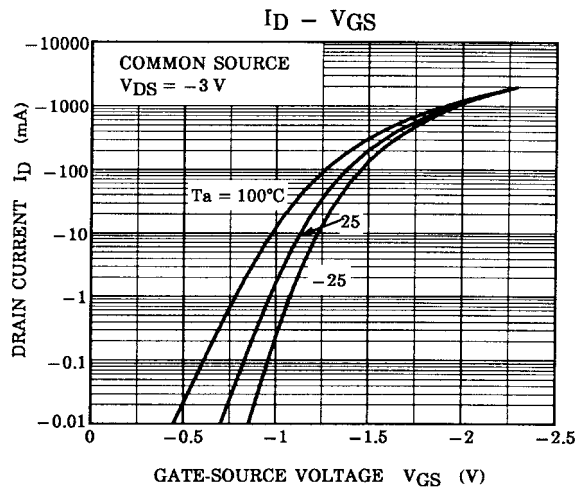
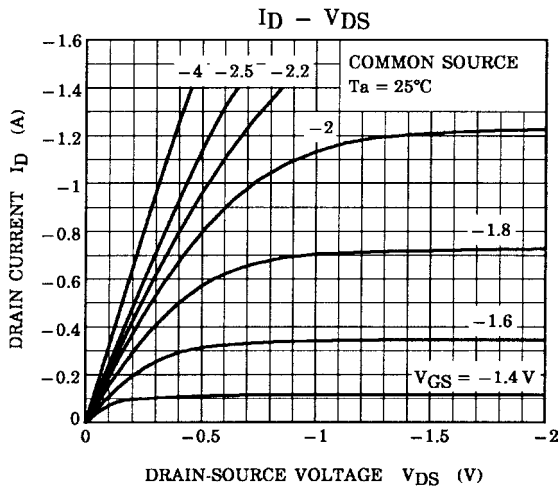

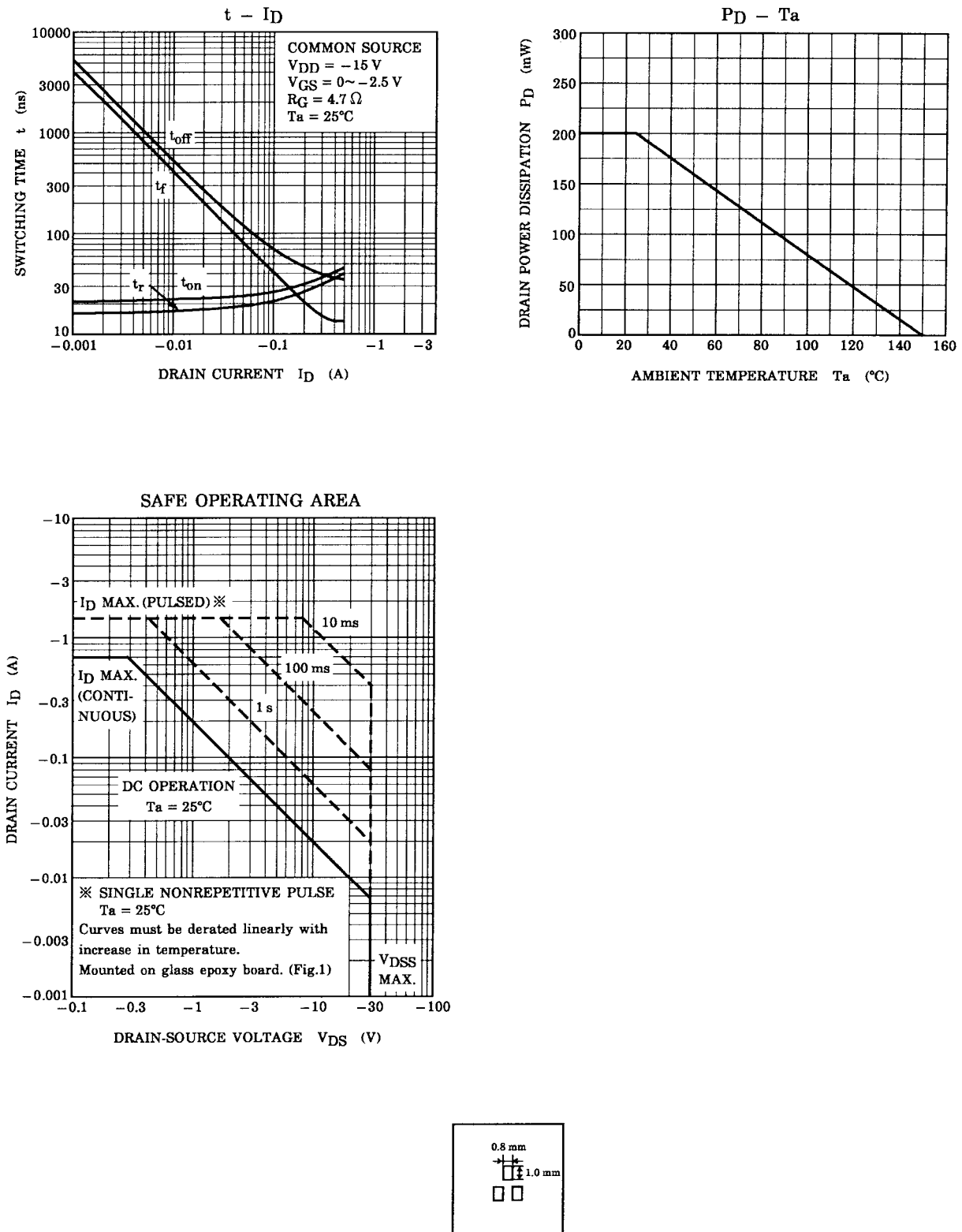

Figure 1 25.4 mm × 25.4 mm × 1.6 t (a Cu pad of 0.8 mm² area)

RESTRICTIONS ON PRODUCT USE

000707EAA

- TOSHIBA is continually working to improve the quality and reliability of its products. Nevertheless, semiconductor devices in general can malfunction or fail due to their inherent electrical sensitivity and vulnerability to physical stress. It is the responsibility of the buyer, when utilizing TOSHIBA products, to comply with the standards of safety in making a safe design for the entire system, and to avoid situations in which a malfunction or failure of such TOSHIBA products could cause loss of human life, bodily injury or damage to property.
In developing your designs, please ensure that TOSHIBA products are used within specified operating ranges as set forth in the most recent TOSHIBA products specifications. Also, please keep in mind the precautions and conditions set forth in the "Handling Guide for Semiconductor Devices," or "TOSHIBA Semiconductor Reliability Handbook" etc..
- The TOSHIBA products listed in this document are intended for usage in general electronics applications (computer, personal equipment, office equipment, measuring equipment, industrial robotics, domestic appliances, etc.). These TOSHIBA products are neither intended nor warranted for usage in equipment that requires extraordinarily high quality and/or reliability or a malfunction or failure of which may cause loss of human life or bodily injury ("Unintended Usage"). Unintended Usage include atomic energy control instruments, airplane or spaceship instruments, transportation instruments, traffic signal instruments, combustion control instruments, medical instruments, all types of safety devices, etc.. Unintended Usage of TOSHIBA products listed in this document shall be made at the customer's own risk.
- The information contained herein is presented only as a guide for the applications of our products. No responsibility is assumed by TOSHIBA CORPORATION for any infringements of intellectual property or other rights of the third parties which may result from its use. No license is granted by implication or otherwise under any intellectual property or other rights of TOSHIBA CORPORATION or others.
- The information contained herein is subject to change without notice.