

# UNR6111/6112/6113/6114/6115/6116/6117/ 6118/6119/6110/611D/611E/611F/611H/611L (UN6111/6112/6113/6114/6115/6116/6117/6118/6119/ 6110/611D/611E/611F/611H/611L)

Silicon PNP epitaxial planer transistor

For digital circuits

## Features

- Costs can be reduced through downsizing of the equipment and reduction of the number of parts.
- MT-1 type package, allowing supply with the radial taping.

## Resistance by Part Number

	(R <sub>1</sub> )	(R <sub>2</sub> )
● UNR6111	10kΩ	10kΩ
● UNR6112	22kΩ	22kΩ
● UNR6113	47kΩ	47kΩ
● UNR6114	10kΩ	47kΩ
● UNR6115	10kΩ	—
● UNR6116	4.7kΩ	—
● UNR6117	22kΩ	—
● UNR6118	0.51kΩ	5.1kΩ
● UNR6119	1kΩ	10kΩ
● UNR6110	47kΩ	—
● UNR611D	47kΩ	10kΩ
● UNR611E	47kΩ	22kΩ
● UNR611F	4.7kΩ	10kΩ
● UNR611H	2.2kΩ	10kΩ
● UNR611L	4.7kΩ	4.7kΩ

## Absolute Maximum Ratings (T<sub>a</sub>=25°C)

Parameter	Symbol	Ratings	Unit
Collector to base voltage	V <sub>CBO</sub>	-50	V
Collector to emitter voltage	V <sub>CEO</sub>	-50	V
Collector current	I <sub>C</sub>	-100	mA
Total power dissipation	P <sub>T</sub>	400	mW
Junction temperature	T <sub>j</sub>	150	°C
Storage temperature	T <sub>stg</sub>	-55 to +150	°C

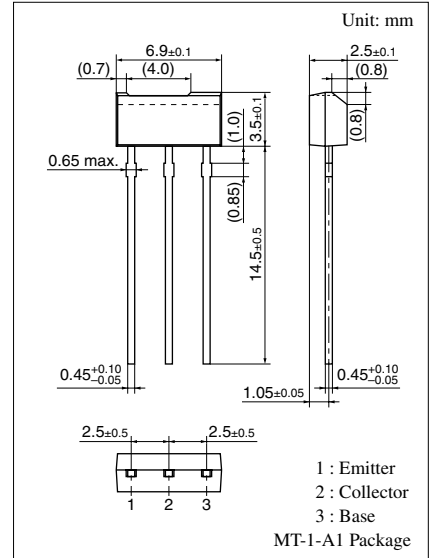

## Internal Connection

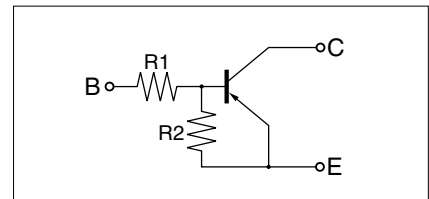

Note) The Part numbers in the Parenthesis show conventional part number.

UNR6111/6112/6113/6114/6115/6116/6117/  
Transistors with built-in Resistor 6118/6119/6110/611D/611E/611F/611H/611L

■ Electrical Characteristics (T<sub>a</sub>=25°C)

Parameter		Symbol	Conditions	min	typ	max	Unit		
Collector cutoff current		I <sub>CBO</sub>	V <sub>CB</sub> = -50V, I <sub>E</sub> = 0			-0.1	μA		
		I <sub>CEO</sub>	V <sub>CE</sub> = -50V, I <sub>B</sub> = 0			-0.5	μA		
Emitter cutoff current	UNR6111	I <sub>EBO</sub>	V <sub>EB</sub> = -6V, I <sub>C</sub> = 0			-0.5	mA		
	UNR6112/6114/611E/611D					-0.2			
	UNR6113					-0.1			
	UNR6115/6116/6117/6110					-0.01			
	UNR611F/611H					-1.0			
	UNR6119					-1.5			
	UNR6118/611L					-2.0			
Collector to base voltage		V <sub>CBO</sub>	I <sub>C</sub> = -10μA, I <sub>E</sub> = 0	-50			V		
Collector to emitter voltage		V <sub>CEO</sub>	I <sub>C</sub> = -2mA, I <sub>B</sub> = 0	-50			V		
Forward current transfer ratio	UNR6111	h <sub>FE</sub>	V <sub>CE</sub> = -10V, I <sub>C</sub> = -5mA	35			V		
	UNR6112/611E			60					
	UNR6113/6114			80					
	UNR6115*/6116*/6117*/6110*			160		460			
	UNR611F/611D/6119/611H			30					
	UNR6118/611L			20					
Collector to emitter saturation voltage		V <sub>CE(sat)</sub>	I <sub>C</sub> = -10mA, I <sub>B</sub> = -0.3mA			-0.25	V		
Output voltage high level		V <sub>OH</sub>	V <sub>CC</sub> = -5V, V <sub>B</sub> = -0.5V, R <sub>L</sub> = 1kΩ	-4.9			V		
Output voltage low level		V <sub>OL</sub>	V <sub>CC</sub> = -5V, V <sub>B</sub> = -2.5V, R <sub>L</sub> = 1kΩ			-0.2	V		
			V <sub>CC</sub> = -5V, V <sub>B</sub> = -3.5V, R <sub>L</sub> = 1kΩ			-0.2			
			V <sub>CC</sub> = -5V, V <sub>B</sub> = -10V, R <sub>L</sub> = 1kΩ			-0.2			
			V <sub>CC</sub> = -5V, V <sub>B</sub> = -6V, R <sub>L</sub> = 1kΩ			-0.2			
Transition frequency		f <sub>T</sub>	V <sub>CB</sub> = -10V, I <sub>E</sub> = 1mA, f = 200MHz		80		MHz		
Input resistance	UNR6111/6114/6115	R <sub>i</sub>		(-30%)		(±30%)	kΩ		
	UNR6112/6117							10	
	UNR6113/6110/611D/611E							22	
	UNR6116/611F/611L							47	
	UNR6118							4.7	
	UNR6119							0.51	
	UNR611H							1	
Resistance ratio	UNR6111/6112/6113/611L	R <sub>1</sub> /R <sub>2</sub>					0.8		
	UNR6114						0.17	0.21	0.25
	UNR6118/6119						0.08	0.1	0.12
	UNR611D						3.7	4.7	5.7
	UNR611E						1.7	2.14	2.6
	UNR611F						0.37	0.47	0.57
	UNR611H						0.17	0.22	0.27

\* h<sub>FE</sub> rank classification (UNR6115/6116/6117/6110)

Rank	Q	R	S
h <sub>FE</sub>	160 to 260	210 to 340	290 to 460

Common characteristics chart

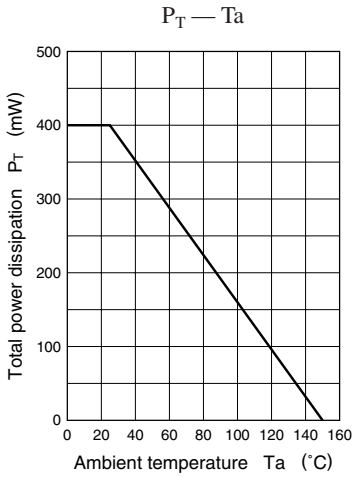

Characteristics charts of UNR6111

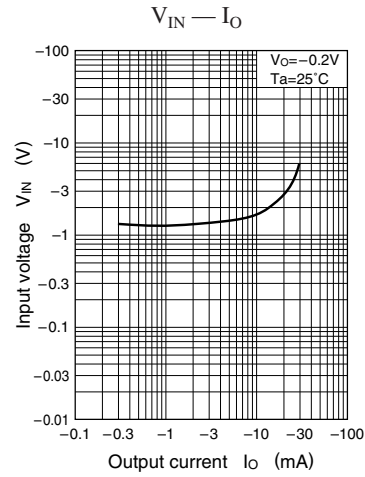
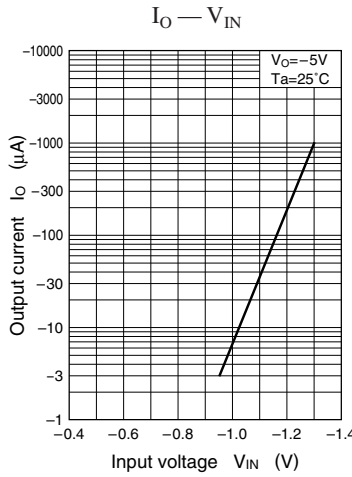
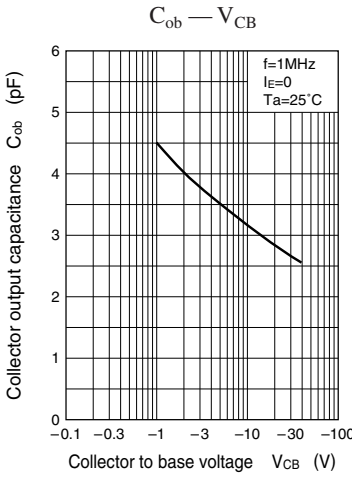
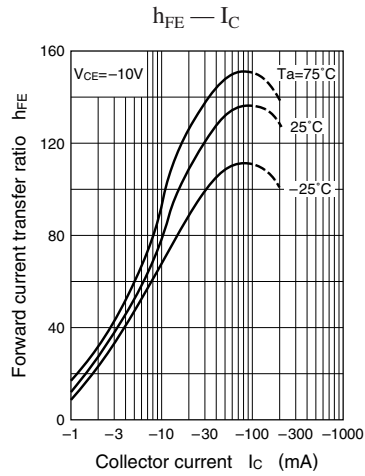
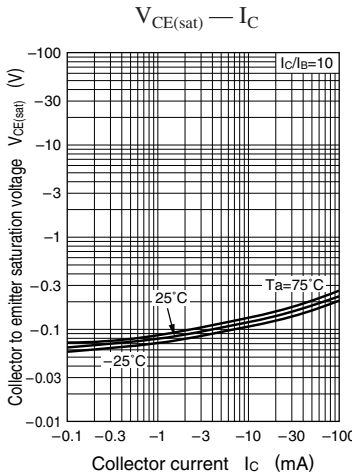
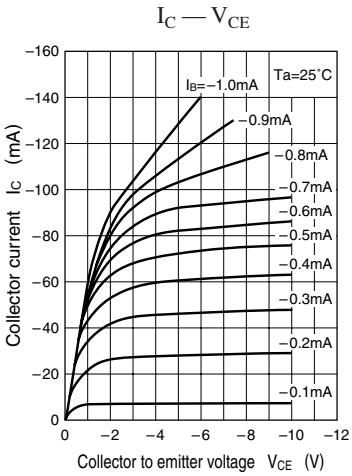

Characteristics charts of UNR6112

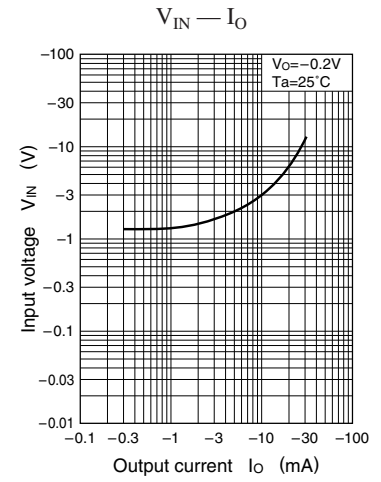
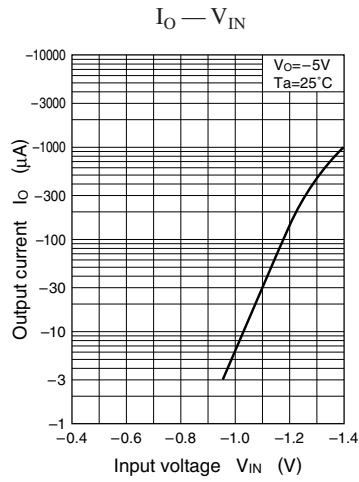
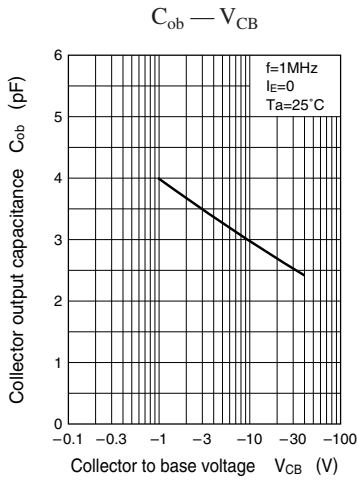
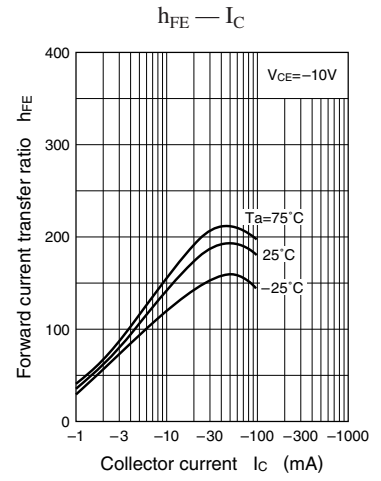
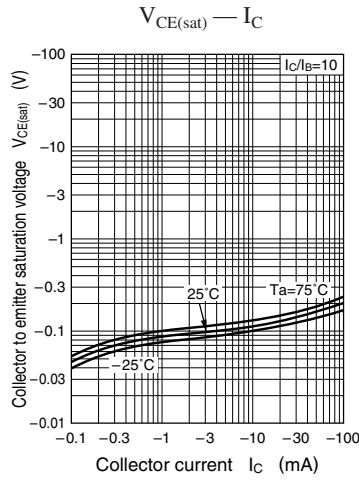
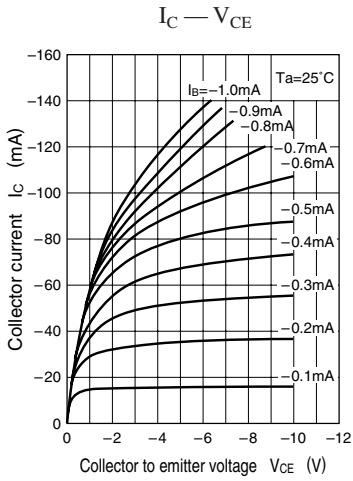

Characteristics charts of UNR6113

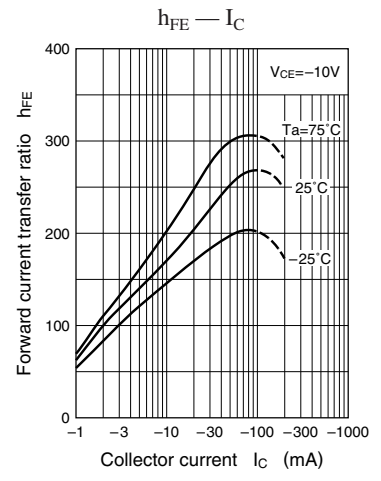
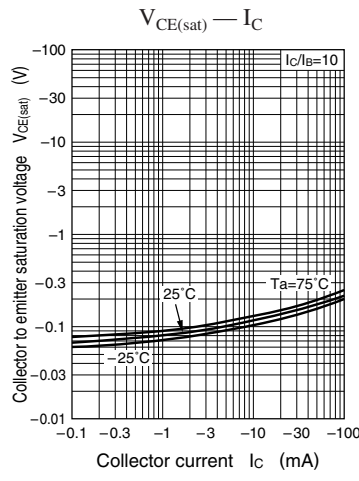
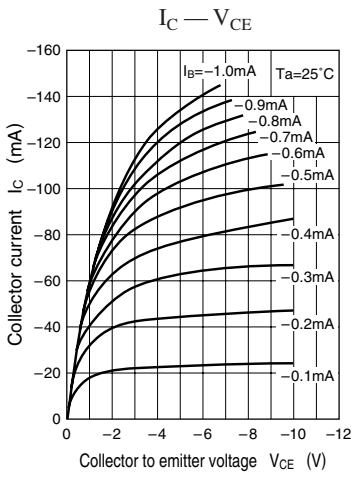

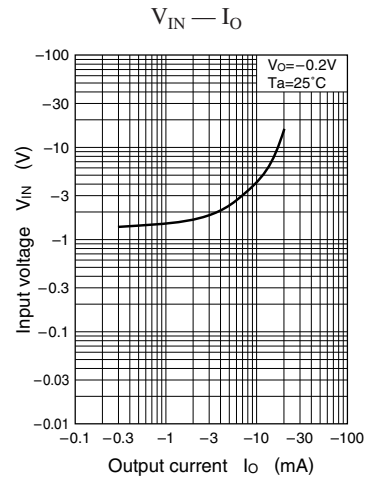
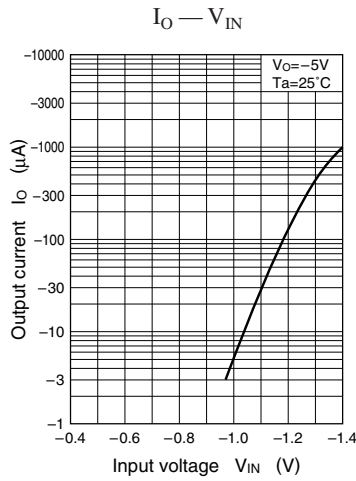
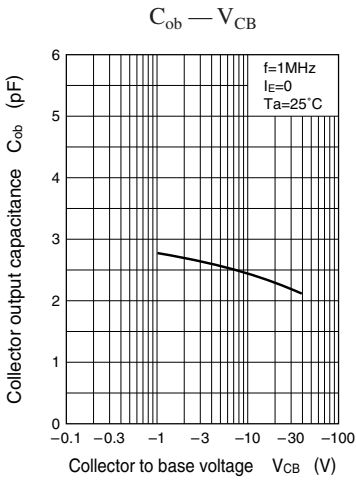

Characteristics charts of UNR6114

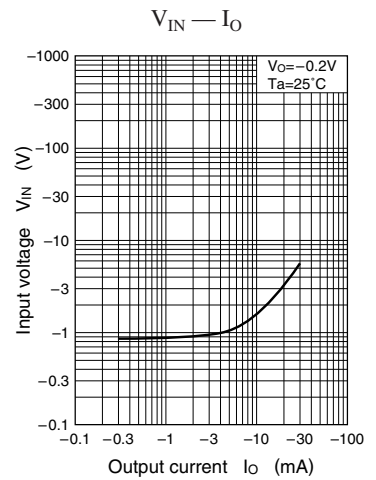
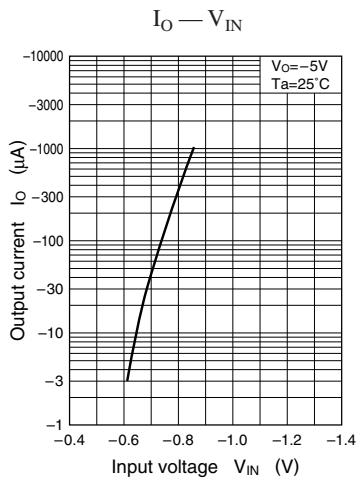
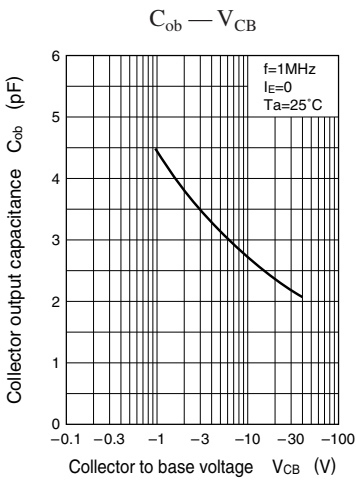
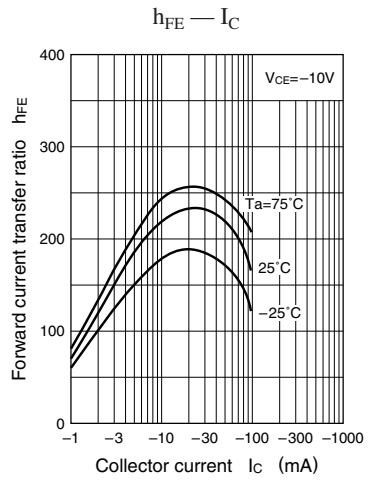
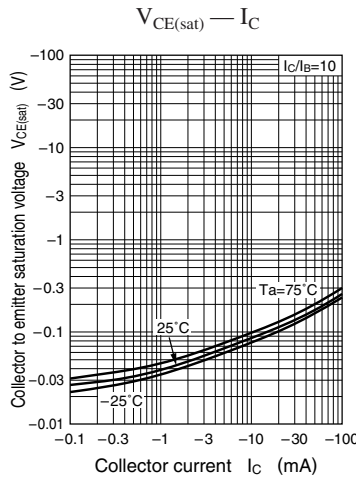
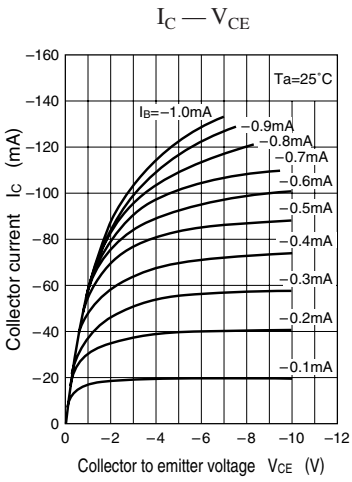

Characteristics charts of UNR6115

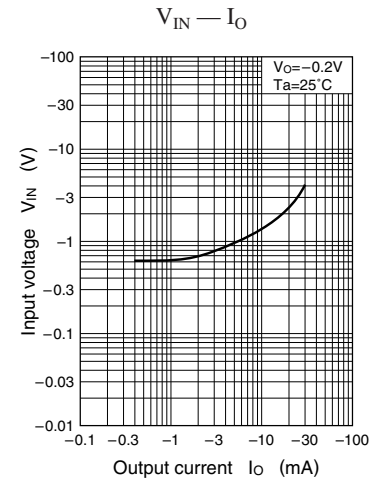
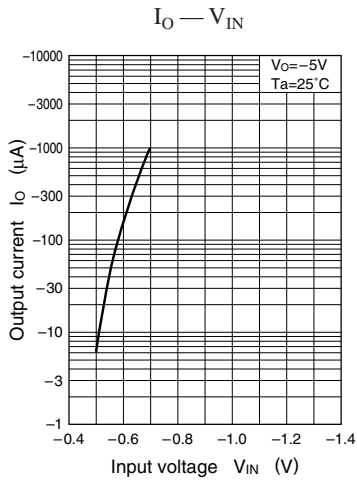
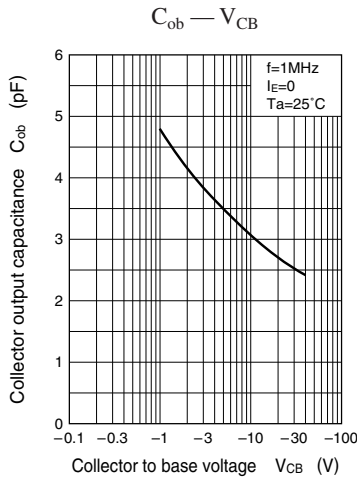
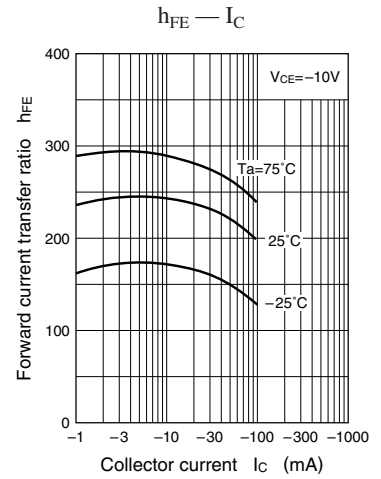
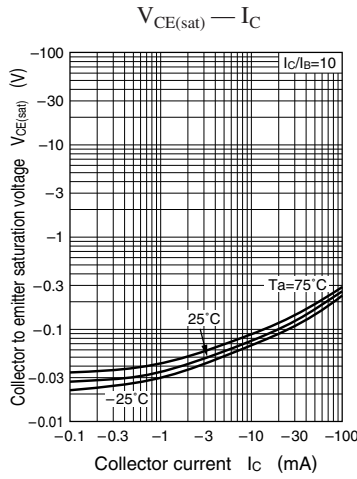
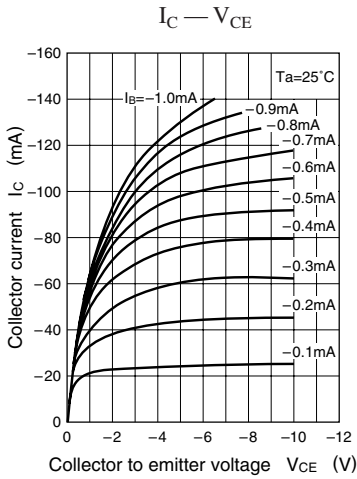

Characteristics charts of UNR6116

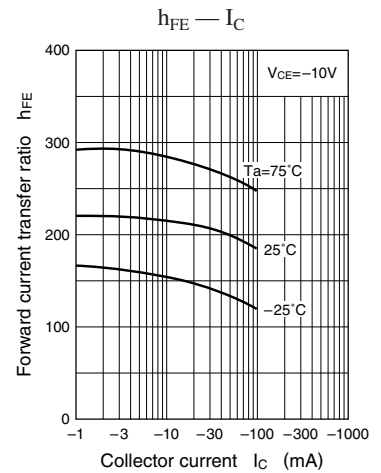
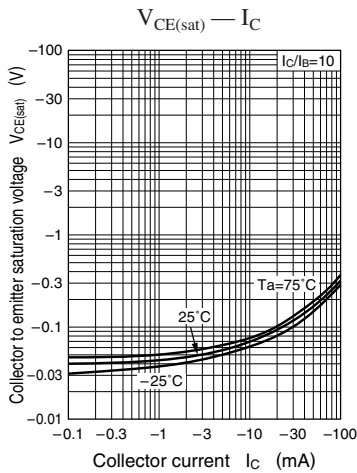
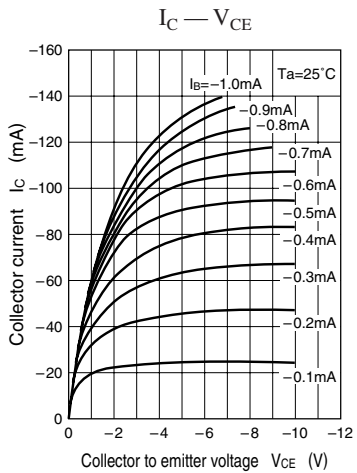

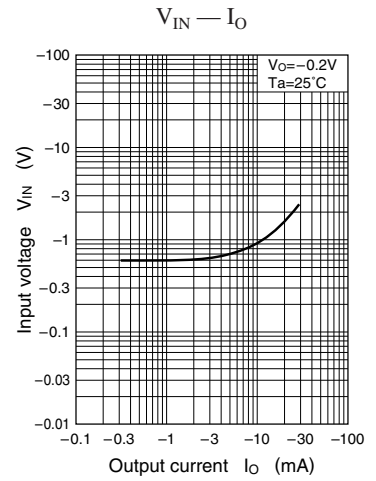
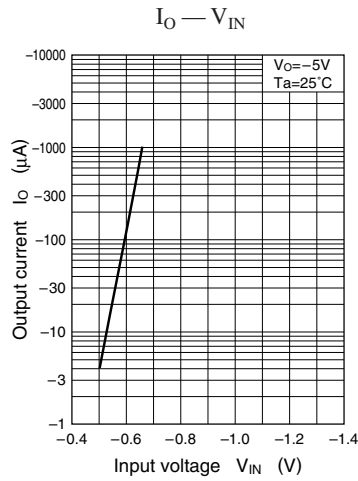
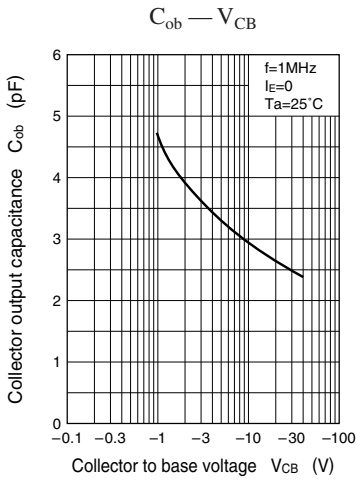

Characteristics charts of UNR6117

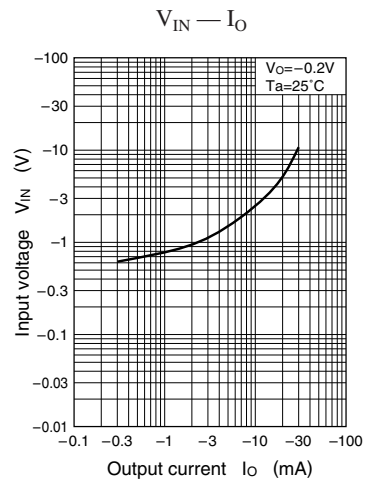
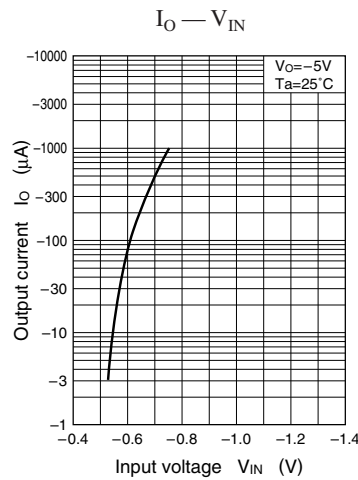
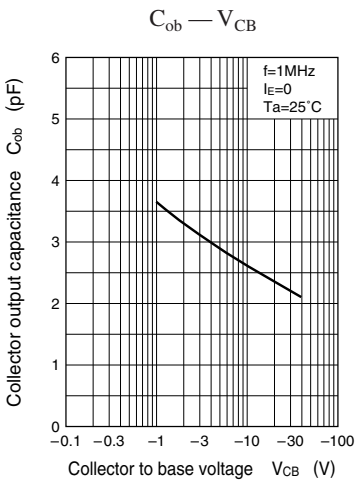
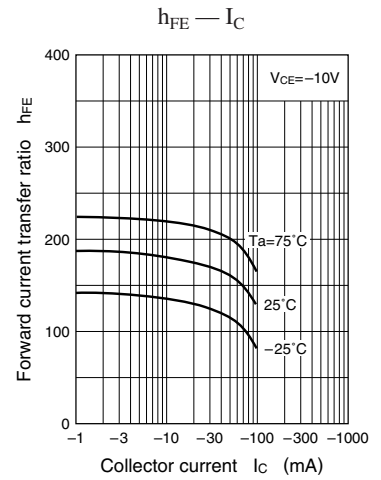
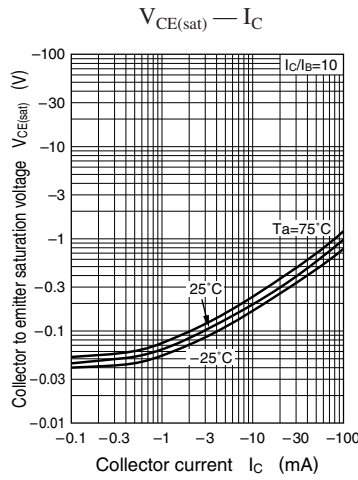
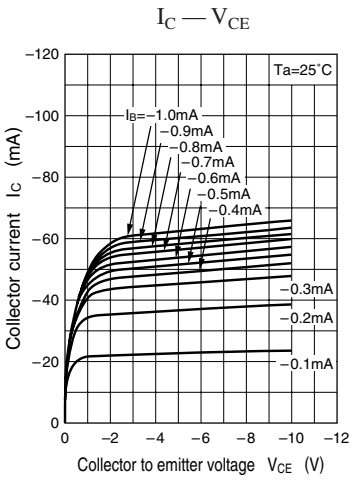

Characteristics charts of UNR6118

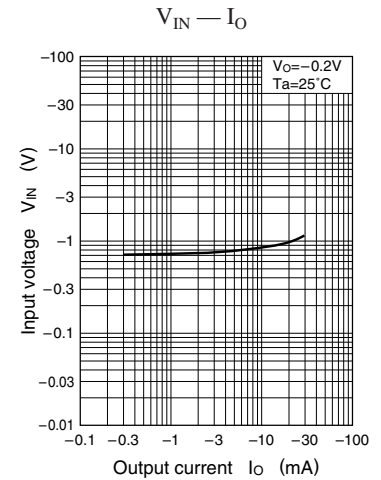
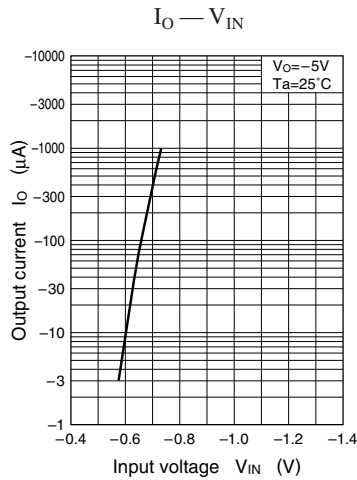
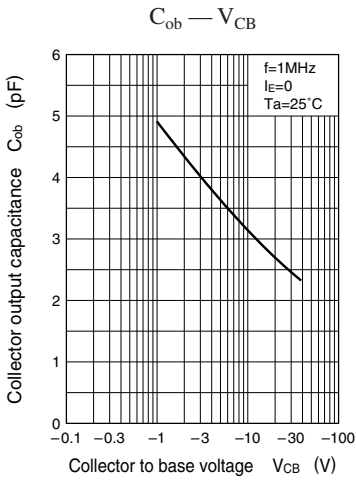
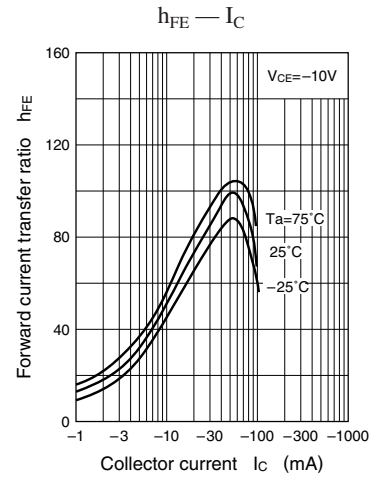
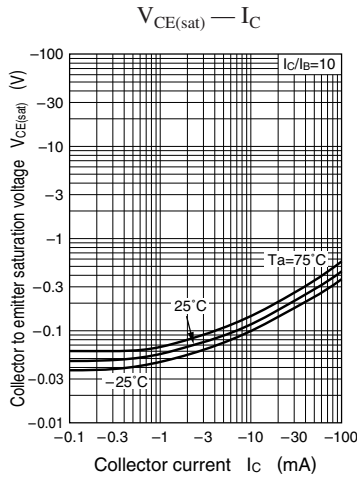
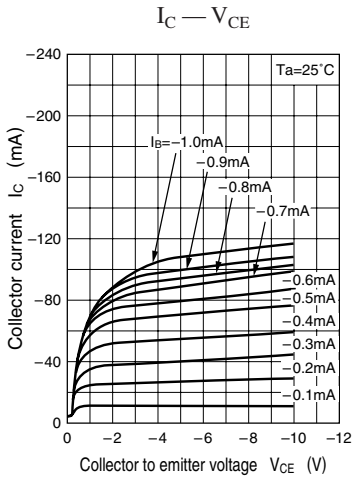

Characteristics charts of UNR6119

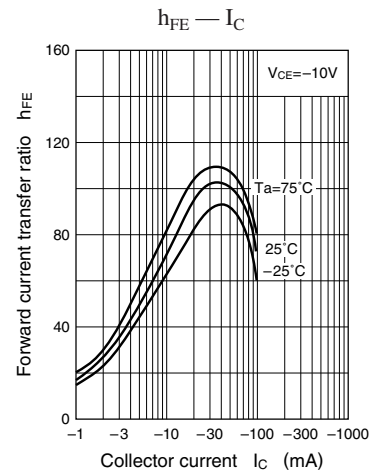
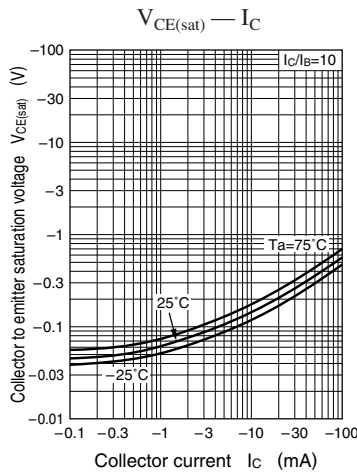
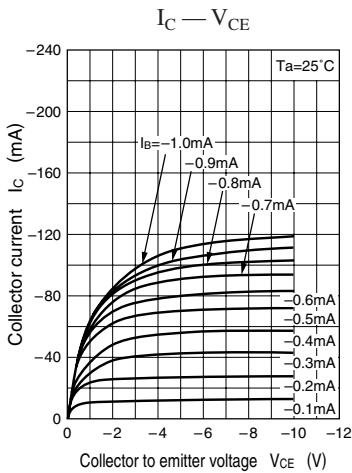



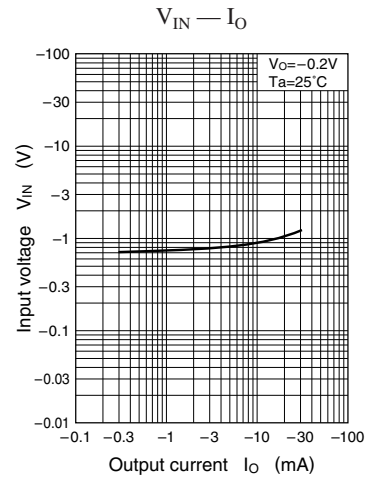
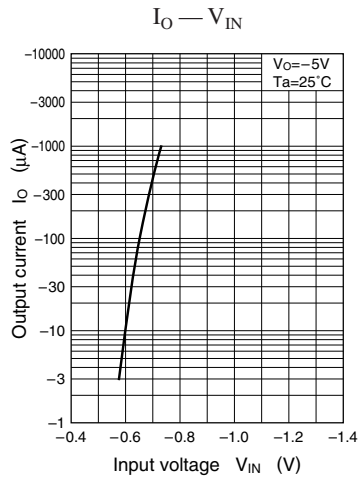
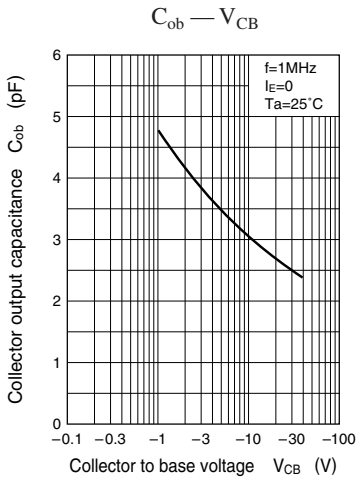

Characteristics charts of UNR6110

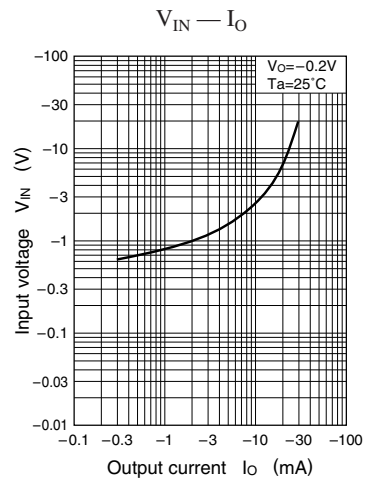
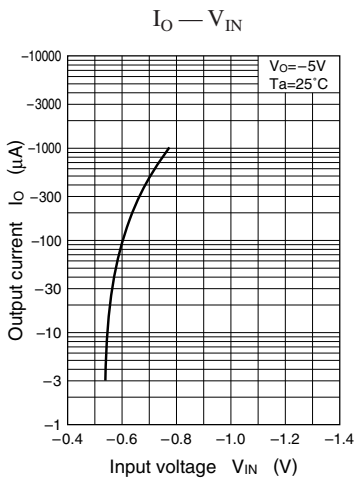
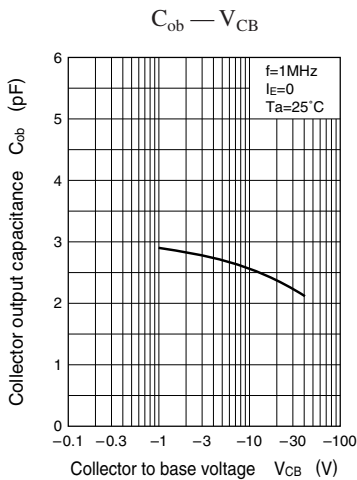
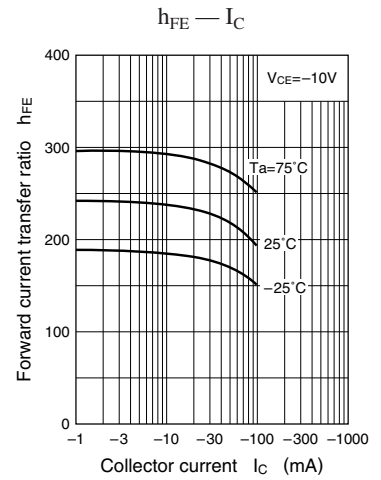
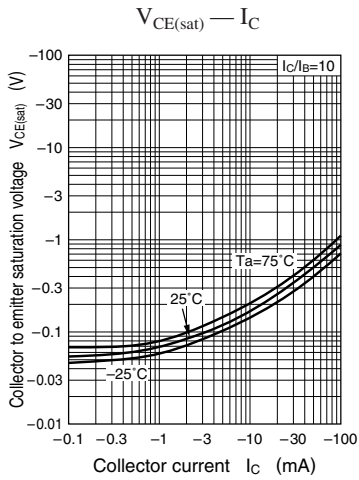
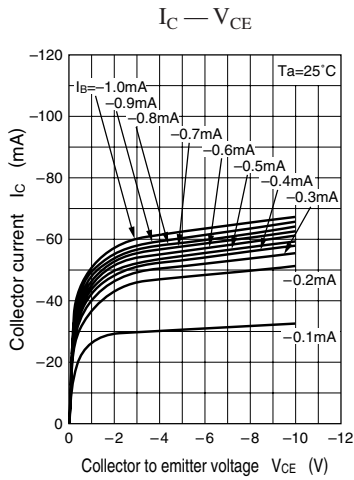

Characteristics charts of UNR611D

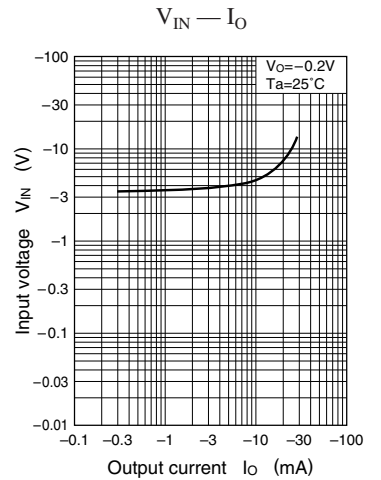
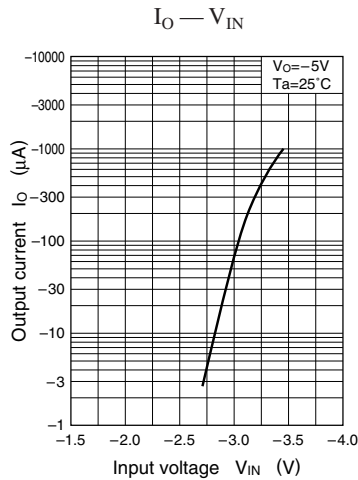
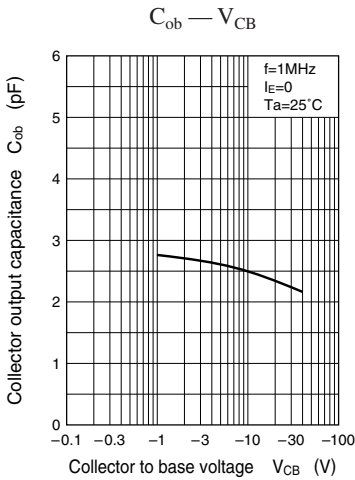
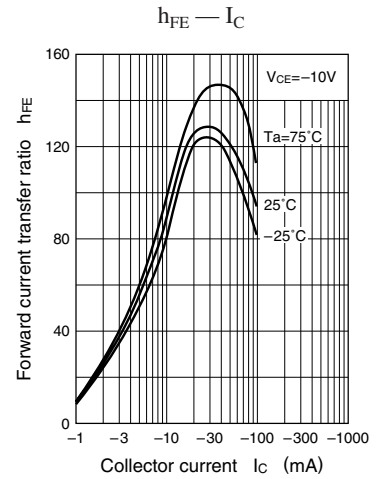
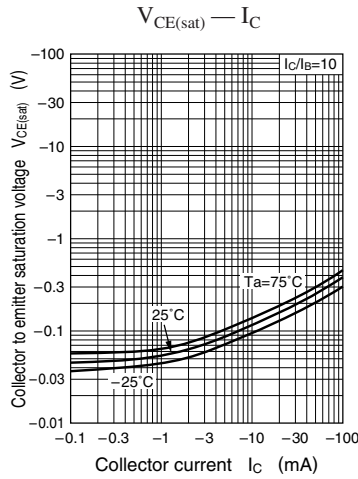
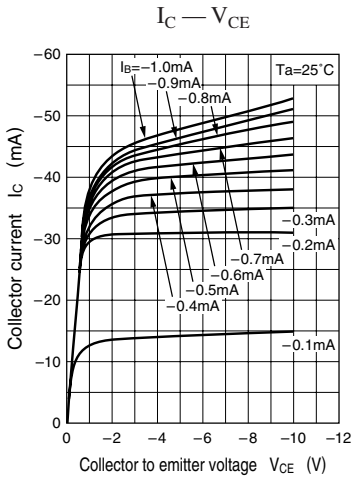

Characteristics charts of UNR611E

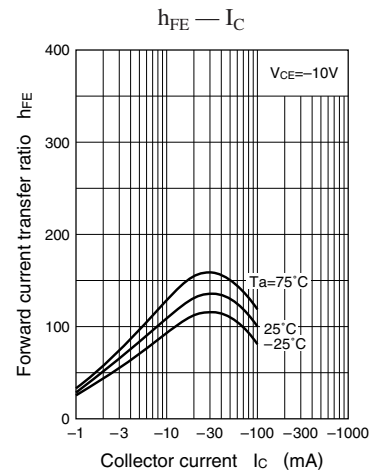
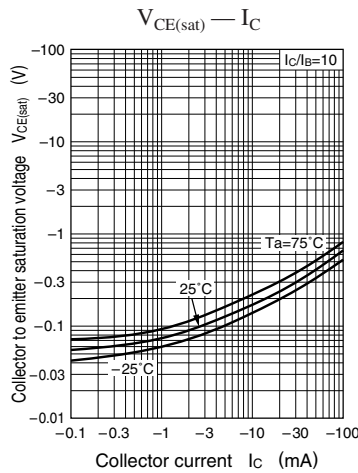
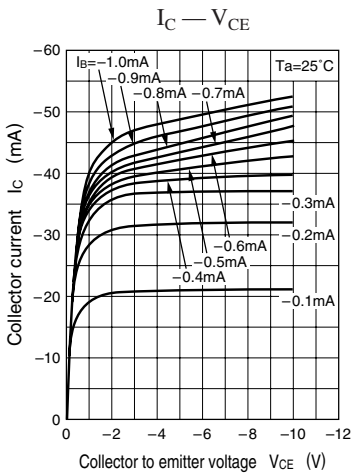

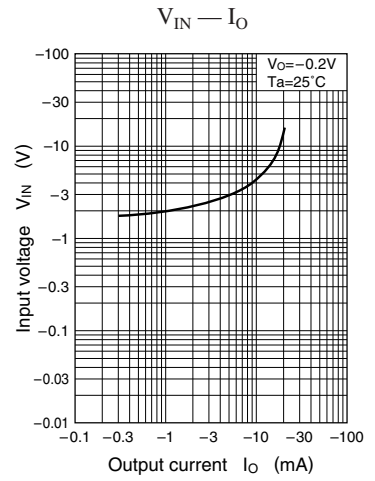
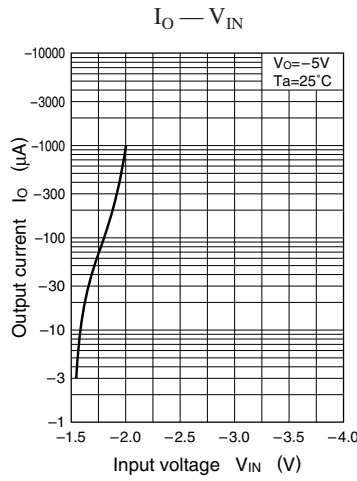
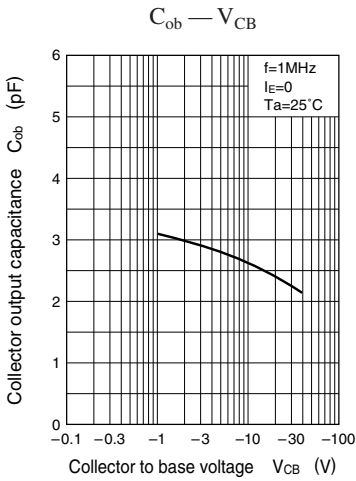

Characteristics charts of UNR611F

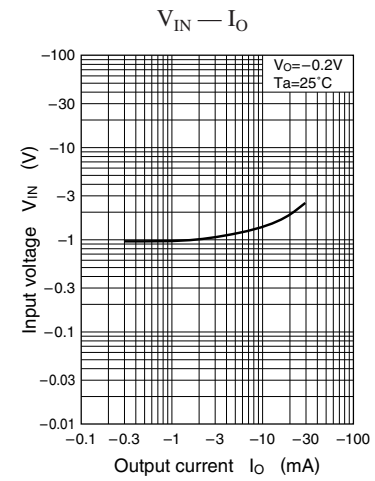
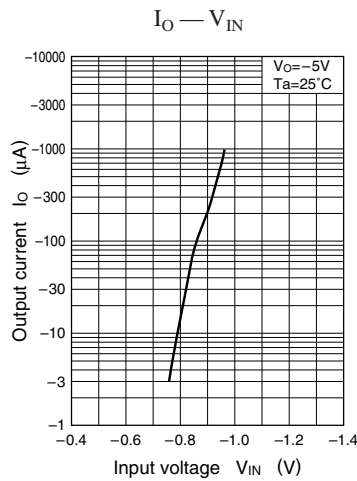
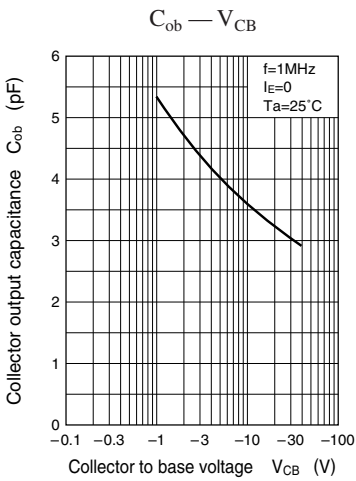
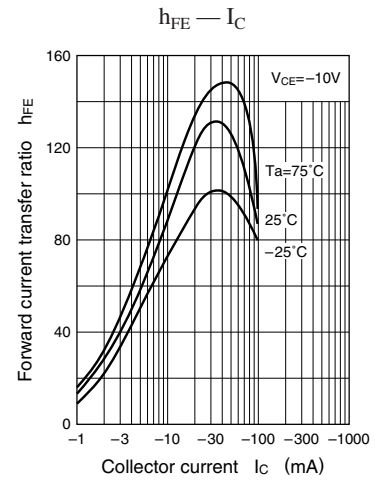
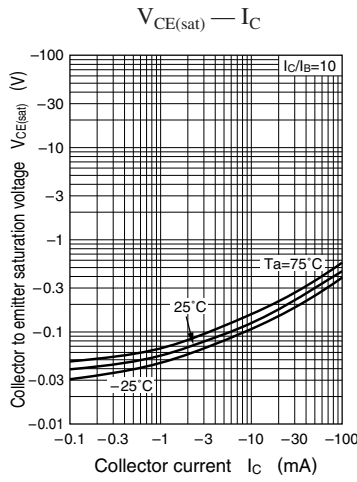
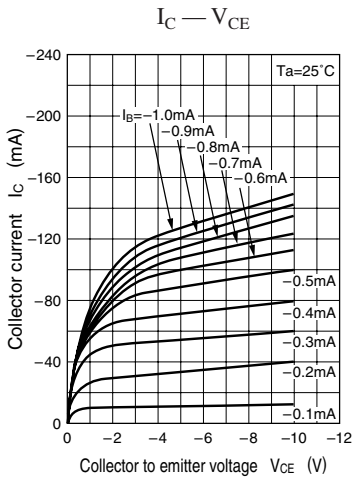

Characteristics charts of UNR611H

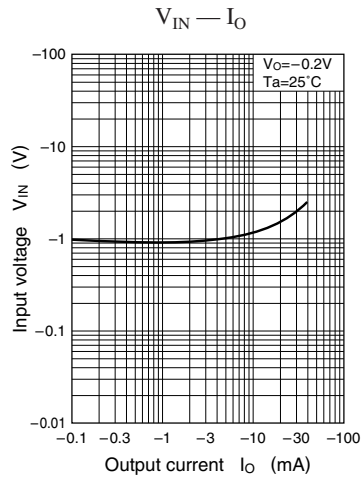
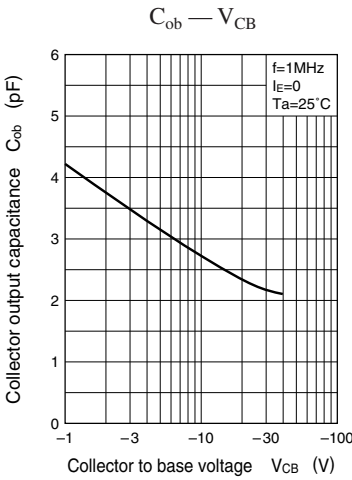
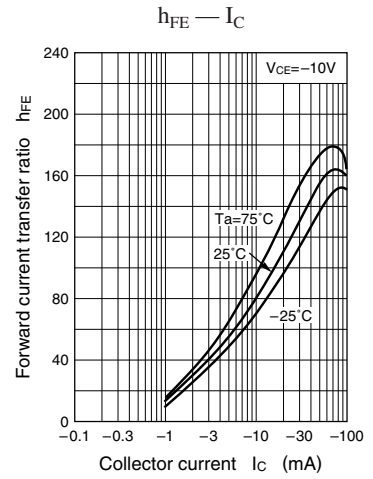
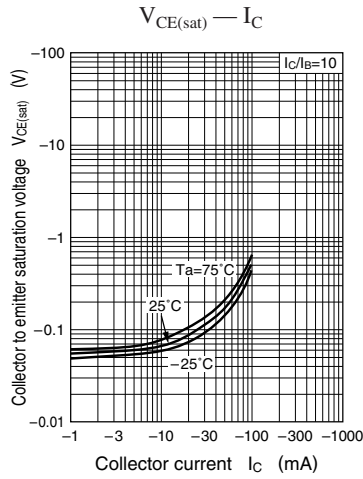
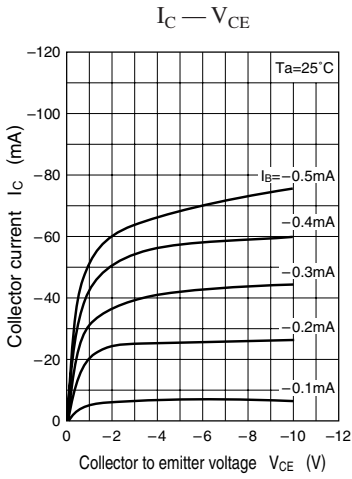

Characteristics charts of UNR611L

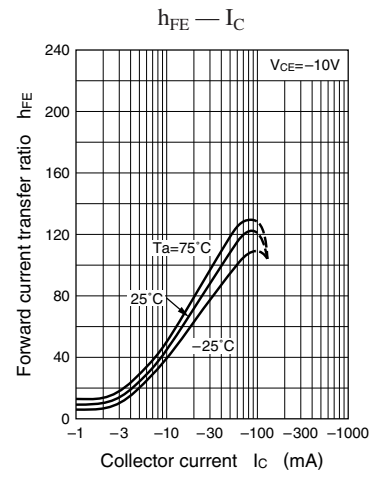
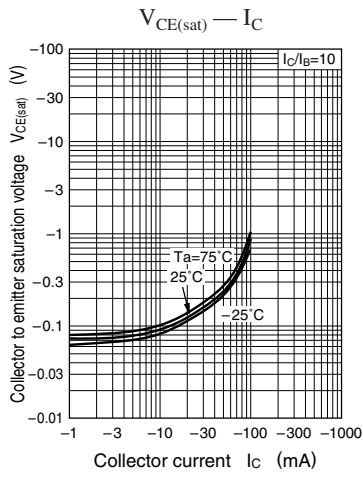
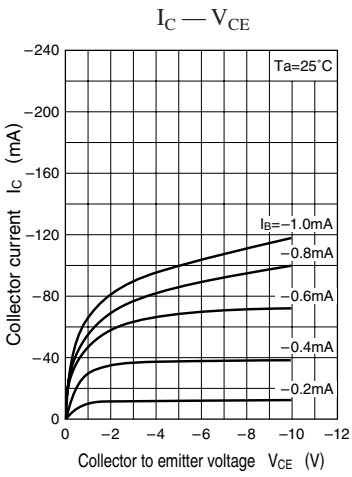

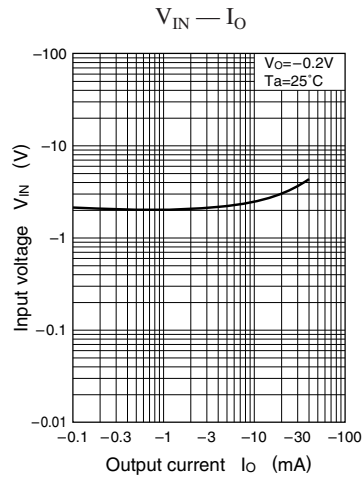
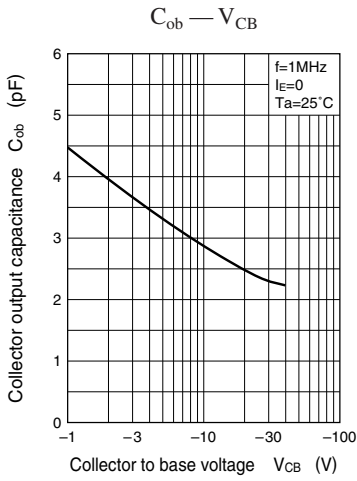

## Request for your special attention and precautions in using the technical information and semiconductors described in this material

- (1) An export permit needs to be obtained from the competent authorities of the Japanese Government if any of the products or technologies described in this material and controlled under the "Foreign Exchange and Foreign Trade Law" is to be exported or taken out of Japan.
- (2) The technical information described in this material is limited to showing representative characteristics and applied circuit examples of the products. It does not constitute the warranting of industrial property, the granting of relative rights, or the granting of any license.
- (3) The products described in this material are intended to be used for standard applications or general electronic equipment (such as office equipment, communications equipment, measuring instruments and household appliances).  
Consult our sales staff in advance for information on the following applications:
  - Special applications (such as for airplanes, aerospace, automobiles, traffic control equipment, combustion equipment, life support systems and safety devices) in which exceptional quality and reliability are required, or if the failure or malfunction of the products may directly jeopardize life or harm the human body.
  - Any applications other than the standard applications intended.
- (4) The products and product specifications described in this material are subject to change without notice for reasons of modification and/or improvement. At the final stage of your design, purchasing, or use of the products, therefore, ask for the most up-to-date Product Standards in advance to make sure that the latest specifications satisfy your requirements.
- (5) When designing your equipment, comply with the guaranteed values, in particular those of maximum rating, the range of operating power supply voltage and heat radiation characteristics. Otherwise, we will not be liable for any defect which may arise later in your equipment.  
Even when the products are used within the guaranteed values, redundant design is recommended, so that such equipment may not violate relevant laws or regulations because of the function of our products.
- (6) When using products for which dry packing is required, observe the conditions (including shelf life and after-unpacking standby time) agreed upon when specification sheets are individually exchanged.
- (7) No part of this material may be reprinted or reproduced by any means without written permission from our company.

## Please read the following notes before using the datasheets

- A. These materials are intended as a reference to assist customers with the selection of Panasonic semiconductor products best suited to their applications.  
Due to modification or other reasons, any information contained in this material, such as available product types, technical data, and so on, is subject to change without notice.  
Customers are advised to contact our semiconductor sales office and obtain the latest information before starting precise technical research and/or purchasing activities.
- B. Panasonic is endeavoring to continually improve the quality and reliability of these materials but there is always the possibility that further rectifications will be required in the future. Therefore, Panasonic will not assume any liability for any damages arising from any errors etc. that may appear in this material.
- C. These materials are solely intended for a customer's individual use.  
Therefore, without the prior written approval of Panasonic, any other use such as reproducing, selling, or distributing this material to a third party, via the Internet or in any other way, is prohibited.